

STATE OF NORTH CAROLINA
DEPARTMENT OF TRANSPORTATION
RALEIGH, N.C.

C204131

CONTRACT AND
CONTRACT BONDS

FOR CONTRACT NO. C204131

WBS 38979.3.1 STATE FUNDED

T.I.P NO. U-2714

COUNTY OF WAYNE

THIS IS THE ROADWAY & CULVERT CONTRACT

ROUTE NUMBER US 117 LENGTH 1.546 MILES

LOCATION US-117 ALTERNATE FROM US-70 BYPASS TO SR-1571 (TOMMY'S RD)
IN GOLDSBORO.

CONTRACTOR BRIDGEPOINT CIVIL LLC

ADDRESS P.O. BOX 729

PIKEVILLE, NC 27863

BIDS OPENED MARCH 17, 2020

CONTRACT EXECUTION 4/13/2020

STATE OF NORTH CAROLINA
DEPARTMENT OF TRANSPORTATION
RALEIGH, N.C.

PROPOSAL

DATE AND TIME OF BID OPENING: **MARCH 17, 2020 AT 2:00 PM**

CONTRACT ID C204131
WBS 38979.3.1

FEDERAL-AID NO. STATE FUNDED

COUNTY WAYNE

T.I.P. NO. U-2714

MILES 1.546

ROUTE NO. US 117

LOCATION US-117 ALTERNATE FROM US-70 BYPASS TO SR-1571 (TOMMY'S RD)
IN GOLDSBORO.

TYPE OF WORK GRADING, DRAINAGE, PAVING, SIGNALS, AND CULVERT.

NOTICE:

ALL BIDDERS SHALL COMPLY WITH ALL APPLICABLE LAWS REGULATING THE PRACTICE OF GENERAL CONTRACTING AS CONTAINED IN CHAPTER 87 OF THE GENERAL STATUTES OF NORTH CAROLINA WHICH REQUIRES THE BIDDER TO BE LICENSED BY THE N.C. LICENSING BOARD FOR CONTRACTORS WHEN BIDDING ON ANY NON-FEDERAL AID PROJECT WHERE THE BID IS \$30,000 OR MORE, EXCEPT FOR CERTAIN SPECIALTY WORK AS DETERMINED BY THE LICENSING BOARD. BIDDERS SHALL ALSO COMPLY WITH ALL OTHER APPLICABLE LAWS REGULATING THE PRACTICES OF ELECTRICAL, PLUMBING, HEATING AND AIR CONDITIONING AND REFRIGERATION CONTRACTING AS CONTAINED IN CHAPTER 87 OF THE GENERAL STATUTES OF NORTH CAROLINA. NOTWITHSTANDING THESE LIMITATIONS ON BIDDING, THE BIDDER WHO IS AWARDED ANY FEDERAL - AID FUNDED PROJECT SHALL COMPLY WITH CHAPTER 87 OF THE GENERAL STATUTES OF NORTH CAROLINA FOR LICENSING REQUIREMENTS WITHIN 60 CALENDAR DAYS OF BID OPENING.

BIDS WILL BE RECEIVED AS SHOWN BELOW:

THIS IS A ROADWAY & CULVERT PROPOSAL

5% BID BOND OR BID DEPOSIT REQUIRED

**PROPOSAL FOR THE CONSTRUCTION OF
CONTRACT No. C204131 IN WAYNE COUNTY, NORTH CAROLINA**

Date _____ **20** _____

**DEPARTMENT OF TRANSPORTATION,
RALEIGH, NORTH CAROLINA**

The Bidder has carefully examined the location of the proposed work to be known as Contract No. C204131 has carefully examined the plans and specifications, which are acknowledged to be part of the proposal, the special provisions, the proposal, the form of contract, and the forms of contract payment bond and contract performance bond; and thoroughly understands the stipulations, requirements and provisions. The undersigned bidder agrees to bound upon his execution of the bid and subsequent award to him by the Board of Transportation in accordance with this proposal to provide the necessary contract payment bond and contract performance bond within fourteen days after the written notice of award is received by him. The undersigned Bidder further agrees to provide all necessary machinery, tools, labor, and other means of construction; and to do all the work and to furnish all materials, except as otherwise noted, necessary to perform and complete the said contract in accordance with *the 2018 Standard Specifications for Roads and Structures* by the dates(s) specified in the Project Special Provisions and in accordance with the requirements of the Engineer, and at the unit or lump sum prices, as the case may be, for the various items given on the sheets contained herein.

The Bidder shall provide and furnish all the materials, machinery, implements, appliances and tools, and perform the work and required labor to construct and complete State Highway Contract No. C204131 in Wayne County, for the unit or lump sum prices, as the case may be, bid by the Bidder in his bid and according to the proposal, plans, and specifications prepared by said Department, which proposal, plans, and specifications show the details covering this project, and hereby become a part of this contract.

The published volume entitled *North Carolina Department of Transportation, Raleigh, Standard Specifications for Roads and Structures, January 2018* with all amendments and supplements thereto, is by reference incorporated into and made a part of this contract; that, except as herein modified, all the construction and work included in this contract is to be done in accordance with the specifications contained in said volume, and amendments and supplements thereto, under the direction of the Engineer.

If the proposal is accepted and the award is made, the contract is valid only when signed either by the Contract Officer or such other person as may be designated by the Secretary to sign for the Department of Transportation. The conditions and provisions herein cannot be changed except over the signature of the said Contract Officer.

The quantities shown in the itemized proposal for the project are considered to be approximate only and are given as the basis for comparison of bids. The Department of Transportation may increase or decrease the quantity of any item or portion of the work as may be deemed necessary or expedient.

An increase or decrease in the quantity of an item will not be regarded as sufficient ground for an increase or decrease in the unit prices, nor in the time allowed for the completion of the work, except as provided for the contract.

Accompanying this bid is a bid bond secured by a corporate surety, or certified check payable to the order of the Department of Transportation, for five percent of the total bid price, which deposit is to be forfeited as liquidated damages in case this bid is accepted and the Bidder shall fail to provide the required payment and performance bonds with the Department of Transportation, under the condition of this proposal, within 14 calendar days after the written notice of award is received by him, as provided in the *Standard Specifications*; otherwise said deposit will be returned to the Bidder.



State Contract Officer

DocuSigned by:

Ronald E. Davenport, Jr.

2/14/2020

F81B6038A47A442...

TABLE OF CONTENTS

COVER SHEET
PROPOSAL SHEET

PROJECT SPECIAL PROVISIONS

CONTRACT TIME AND LIQUIDATED DAMAGES: G-1
 INTERMEDIATE CONTRACT TIME NUMBER 1 AND LIQUIDATED DAMAGES: G-1
 INTERMEDIATE CONTRACT TIME NUMBER 2 AND LIQUIDATED DAMAGES: G-2
 INTERMEDIATE CONTRACT TIME NUMBER 3 AND LIQUIDATED DAMAGES: G-3
 INTERMEDIATE CONTRACT TIME NUMBER 4 AND LIQUIDATED DAMAGES: G-3
 INTERMEDIATE CONTRACT TIME NUMBER 5 AND LIQUIDATED DAMAGES: G-4
 INTERMEDIATE CONTRACT TIME NUMBER 6 AND LIQUIDATED DAMAGES: G-4
 INTERMEDIATE CONTRACT TIME NUMBER 7 AND LIQUIDATED DAMAGES: G-4
 INTERMEDIATE CONTRACT TIME NUMBER 8 AND LIQUIDATED DAMAGES: G-4
 PERMANENT VEGETATION ESTABLISHMENT:..... G-5
 AWARD OF CONTRACT:..... G-5
 MAJOR CONTRACT ITEMS: G-6
 SPECIALTY ITEMS:..... G-6
 FUEL PRICE ADJUSTMENT:..... G-6
 SCHEDULE OF ESTIMATED COMPLETION PROGRESS:..... G-7
 MINORITY BUSINESS ENTERPRISE AND WOMEN BUSINESS ENTERPRISE:..... G-7
 CONTRACTOR'S LICENSE REQUIREMENTS:..... G-23
 USE OF UNMANNED AIRCRAFT SYSTEM (UAS): G-23
 SUBSURFACE INFORMATION:..... G-23
 MAINTENANCE OF THE PROJECT: G-23
 ELECTRONIC BIDDING:..... G-24
 TWELVE MONTH GUARANTEE: G-24
 OUTSOURCING OUTSIDE THE USA:..... G-25
 EROSION AND SEDIMENT CONTROL/STORMWATER CERTIFICATION: G-25
 PROCEDURE FOR MONITORING BORROW PIT DISCHARGE:..... G-30

 ROADWAY..... R-1

STANDARD SPECIAL PROVISIONS

AVAILABILITY FUNDS – TERMINATION OF CONTRACTS..... SSP-1
 NCDOT GENERAL SEED SPECIFICATION FOR SEED QUALITY SSP-2
 ERRATA..... SSP-5
 PLANT AND PEST QUARANTINES SSP-6
 MINIMUM WAGES SSP-7
 TITLE VI AND NONDISCRIMINATION SSP-8
 ON-THE-JOB TRAINING SSP-16

UNIT PROJECT SPECIAL PROVISIONS

GEOTECHNICAL.....GT-1.1
 GEOENVIRONMENTAL.....GV-1

PAVEMENT MARKINGS..... PM-1
 TRAFFIC CONTROL TC-1
 UTILITY CONSTRUCTION UC-1
 UTILITY BY OTHERS.....UBO-1
 EROSION CONTROL EC-1
 TRAFFIC SIGNALS TS-1
 STRUCTURE / CULVERTS..... ST-1

PERMITS P-1

PROPOSAL ITEM SHEET

ITEM SHEET(S) (TAN SHEETS)

PROJECT SPECIAL PROVISIONS**GENERAL****CONTRACT TIME AND LIQUIDATED DAMAGES:**

(8-15-00) (Rev. 12-18-07)

108

SP1 G07 A

The date of availability for this contract is **September 1, 2020**, except that work in jurisdictional waters and wetlands shall not begin until a meeting between the DOT, Regulatory Agencies, and the Contractor is held as stipulated in the permits contained elsewhere in this proposal. This delay in availability has been considered in determining the contract time for this project.

The completion date for this contract is **May 22, 2024**.

Except where otherwise provided by the contract, observation periods required by the contract will not be a part of the work to be completed by the completion date and/or intermediate contract times stated in the contract. The acceptable completion of the observation periods that extend beyond the final completion date shall be a part of the work covered by the performance and payment bonds.

The liquidated damages for this contract are **Two Hundred Dollars (\$ 200.00)** per calendar day. These liquidated damages will not be cumulative with any liquidated damages which may become chargeable under Intermediate Contract Time Number 1.

INTERMEDIATE CONTRACT TIME NUMBER 1 AND LIQUIDATED DAMAGES:

(7-1-95) (Rev. 2-21-12)

108

SP1 G13 A

Except for that work required under the Project Special Provisions entitled *Planting, Reforestation* and/or *Permanent Vegetation Establishment*, included elsewhere in this proposal, the Contractor will be required to complete all work included in this contract and shall place and maintain traffic on same.

The date of availability for this intermediate contract time is **September 1, 2020**.

The completion date for this intermediate contract time is **September 1, 2023**.

The liquidated damages for this intermediate contract time are **Two Thousand Dollars (\$ 2,000.00)** per calendar day.

Upon apparent completion of all the work required to be completed by this intermediate date, a final inspection will be held in accordance with Article 105-17 and upon acceptance, the Department will assume responsibility for the maintenance of all work except *Planting, Reforestation* and/or *Permanent Vegetation Establishment*. The Contractor will be responsible for and shall make corrections of all damages to the completed roadway caused by his planting operations, whether occurring prior to or after placing traffic through the project.

INTERMEDIATE CONTRACT TIME NUMBER 2 AND LIQUIDATED DAMAGES:

(2-20-07)

108

SP1 G14 A

The Contractor shall complete the required work of installing, maintaining, and removing the traffic control devices for lane closures and restoring traffic to the existing traffic pattern. The Contractor shall not close or narrow a lane of traffic on **US-117 Bus./NC-111 (N. William St.)** during the following time restrictions:

DAY AND TIME RESTRICTIONS**Monday thru Friday:****6:00 a.m. to 9:00 a.m.****and 4:00 p.m. to 7:00 p.m.**

In addition, the Contractor shall not close or narrow a lane of traffic on **US-117 Bus./NC-111 (N. William St.) and Any -Y- Line**, detain and/or alter the traffic flow on or during holidays, holiday weekends, special events, or any other time when traffic is unusually heavy, including the following schedules:

HOLIDAY AND HOLIDAY WEEKEND LANE CLOSURE RESTRICTIONS

1. For **unexpected occurrence** that creates unusually high traffic volumes, as directed by the Engineer.
2. For **New Year's Day**, between the hours of **6:00 a.m.** December 31st and **7:00 p.m.** January 2nd. If New Year's Day is on a Friday, Saturday, Sunday or Monday, then until **7:00 p.m.** the following Tuesday.
3. For **Easter**, between the hours of **6:00 a.m.** Thursday and **7:00 p.m.** Monday.
4. For **Memorial Day**, between the hours of **6:00 a.m.** Friday and **7:00 p.m.** Tuesday.
5. For **Independence Day**, between the hours of **6:00 a.m.** the day before Independence Day and **7:00 p.m.** the day after Independence Day.

If **Independence Day** is on a Friday, Saturday, Sunday or Monday, then between the hours of **6:00 a.m.** the Thursday before Independence Day and **7:00 p.m.** the Tuesday after Independence Day.
6. For **Labor Day**, between the hours of **6:00 a.m.** Friday and **7:00 p.m.** Tuesday.
7. For **Thanksgiving**, between the hours of **6:00 a.m.** Tuesday and **7:00 p.m.** Monday.
8. For **Christmas**, between the hours of **6:00 a.m.** the Friday before the week of Christmas Day and **7:00 p.m.** the following Tuesday after the week of Christmas Day.

Holidays and holiday weekends shall include New Year's, Easter, Memorial Day, Independence Day, Labor Day, Thanksgiving, and Christmas. The Contractor shall schedule his work so that lane closures will not be required during these periods, unless otherwise directed by the Engineer.

The time of availability for this intermediate contract work shall be the time the Contractor begins to install all traffic control devices for lane closures according to the time restrictions listed herein.

The completion time for this intermediate contract work shall be the time the Contractor is required to complete the removal of all traffic control devices for lane closures according to the time restrictions stated above and place traffic in the existing traffic pattern.

The liquidated damages are **One Thousand Dollars (\$ 1,000.00)** per hour.

INTERMEDIATE CONTRACT TIME NUMBER 3 AND LIQUIDATED DAMAGES:

(2-20-07)

108

SP1 G14 C

The Contractor shall complete the required work of installing, maintaining and removing the traffic control devices for lane closures and restoring traffic to the existing traffic pattern. The Contractor shall not close or narrow a lane of traffic on **Any -Y- Line** during the following time restrictions:

DAY AND TIME RESTRICTIONS

Monday thru Friday:

6:00 a.m. to 9:00 a.m.

and 4:00 p.m. to 7:00 p.m.

The time of availability for this intermediate contract time will be the time the Contractor begins to install traffic control devices required for the lane closures according to the time restrictions stated herein.

The completion time for this intermediate contract time will be the time the Contractor is required to complete the removal of traffic control devices required for the lane closures according to the time restrictions stated herein and restore traffic to the existing traffic pattern.

The liquidated damages are **Five Hundred Dollars (\$ 500.00)** per hour.

INTERMEDIATE CONTRACT TIME NUMBER 4 AND LIQUIDATED DAMAGES:

(2-20-07) (Rev. 6-18-13)

108

SP1 G14 H

The Contractor shall complete the work required of **Phase I, Step #1A** as shown on Sheet **TMP-3** and shall place and maintain traffic on same.

The date of availability for this intermediate contract time is the date the Contractor elects to begin the work.

The completion date for this intermediate contract time is the date which is **Sixty (60)** consecutive calendar days after and including the date the Contractor begins this work.

The liquidated damages are **Five Hundred Dollars (\$ 500.00)** per calendar day.

INTERMEDIATE CONTRACT TIME NUMBER 5 AND LIQUIDATED DAMAGES:

(2-20-07) (Rev. 6-18-13)

108

SP1 G14 H

The Contractor shall complete the work required of **Phase I, Step #1B** as shown on Sheet **TMP-3** and shall place and maintain traffic on same.

The date of availability for this intermediate contract time is the date the Contractor elects to begin the work.

The completion date for this intermediate contract time is the date which is **Fourteen (14)** consecutive calendar days after and including the date the Contractor begins this work.

The liquidated damages are **Five Hundred Dollars (\$ 500.00)** per calendar day.

INTERMEDIATE CONTRACT TIME NUMBER 6 AND LIQUIDATED DAMAGES:

(2-20-07) (Rev. 6-18-13)

108

SP1 G14 H

The Contractor shall complete the work required of **Phase II, Step #1A** as shown on Sheet **TMP-3** and shall place and maintain traffic on same.

The date of availability for this intermediate contract time is the date the Contractor elects to begin the work.

The completion date for this intermediate contract time is the date which is **Sixty (60)** consecutive calendar days after and including the date the Contractor begins this work.

The liquidated damages are **Five Hundred Dollars (\$ 500.00)** per calendar day.

INTERMEDIATE CONTRACT TIME NUMBER 7 AND LIQUIDATED DAMAGES:

(2-20-07) (Rev. 6-18-13)

108

SP1 G14 H

The Contractor shall complete the work required of **Phase II, Step #1B** as shown on Sheet **TMP- 3** and shall place and maintain traffic on same.

The date of availability for this intermediate contract time is the date the Contractor elects to begin the work.

The completion date for this intermediate contract time is the date which is **Fourteen (14)** consecutive calendar days after and including the date the Contractor begins this work.

The liquidated damages are **Five Hundred Dollars (\$ 500.00)** per calendar day.

INTERMEDIATE CONTRACT TIME NUMBER 8 AND LIQUIDATED DAMAGES:

(2-20-07) (Rev. 6-18-13)

108

SP1 G14 H

The Contractor shall complete the work required of **Phase II, Step #2** as shown on Sheet **TMP-3** and shall place and maintain traffic on same.

The date of availability for this intermediate contract time is the date the Contractor elects to begin the work.

The completion date for this intermediate contract time is the date which is **Thirty (30)** consecutive calendar days after and including the date the Contractor begins this work.

The liquidated damages are **One Thousand Dollars (\$ 1,000.00)** per calendar day.

PERMANENT VEGETATION ESTABLISHMENT:

(2-16-12) (Rev. 10-15-13)

104

SP1 G16

Establish a permanent stand of the vegetation mixture shown in the contract. During the period between initial vegetation planting and final project acceptance, perform all work necessary to establish permanent vegetation on all erodible areas within the project limits, as well as, in borrow and waste pits. This work shall include erosion control device maintenance and installation, repair seeding and mulching, supplemental seeding and mulching, mowing, and fertilizer topdressing, as directed. All work shall be performed in accordance with the applicable section of the *2018 Standard Specifications*. All work required for initial vegetation planting shall be performed as a part of the work necessary for the completion and acceptance of the Intermediate Contract Time (ICT). Between the time of ICT and Final Project acceptance, or otherwise referred to as the vegetation establishment period, the Department will be responsible for preparing the required National Pollutant Discharge Elimination System (NPDES) inspection records.

Once the Engineer has determined that the permanent vegetation establishment requirement has been achieved at an 80% vegetation density (the amount of established vegetation per given area to stabilize the soil) and no erodible areas exist within the project limits, the Contractor will be notified to remove the remaining erosion control devices that are no longer needed. The Contractor will be responsible for, and shall correct any areas disturbed by operations performed in permanent vegetation establishment and the removal of temporary erosion control measures, whether occurring prior to or after placing traffic on the project.

Payment for *Response for Erosion Control, Seeding and Mulching, Repair Seeding, Supplemental Seeding, Mowing, Fertilizer Topdressing, Silt Excavation, and Stone for Erosion Control* will be made at contract unit prices for the affected items. Work required that is not represented by contract line items will be paid in accordance with Articles 104-7 or 104-3 of the *2018 Standard Specifications*. No additional compensation will be made for maintenance and removal of temporary erosion control items.

AWARD OF CONTRACT:

Revise the *2018 Standard Specifications* as follows:

Page 1-23, Subarticle 103-4 (A) General, first paragraph, replace the 3rd and 4th sentences with the following:

Where award is to be made, the notice of award will be issued within 60 days after the opening of bids or upon issuance of any necessary debt instrument, whichever is later, but not to exceed 120 days; except with the consent of the lowest responsible bidder the decision to award the contract to such bidder may be delayed for as long a time as may be agreed upon by the Department and such bidder. In the absence of such agreement, the lowest responsible bidder may withdraw his bid at the expiration of 120 days without penalty if no notice of award has been issued.

MAJOR CONTRACT ITEMS:

(2-19-02)

104

SP1 G28

The following listed items are the major contract items for this contract (see Article 104-5 of the 2018 Standard Specifications):

Line #	Description
43 —	Asphalt Concrete Base Course, Type B25.0 C
44 —	Asphalt Concrete Intermediate Course, Type I19.0 C
45 —	Asphalt Concrete Surface Course, Type S9.5B

SPECIALTY ITEMS:

(7-1-95)(Rev. 1-17-12)

108-6

SP1 G37

Items listed below will be the specialty items for this contract (see Article 108-6 of the 2018 Standard Specifications).

Line #	Description
77-81	Guardrail
85-99	Signing
113-118, 130-131	Long-Life Pavement Markings
132	Permanent Pavement Markers
133-188	Utility Construction
189-219, 221-222	Erosion Control
220	Reforestation
223-256	Signals/ITS System

FUEL PRICE ADJUSTMENT:

(11-15-05) (Rev. 2-18-14)

109-8

SP1 G43

Revise the 2018 Standard Specifications as follows:

Page 1-87, Article 109-8, Fuel Price Adjustments, add the following:

The base index price for DIESEL #2 FUEL is \$ **1.8495** per gallon. Where any of the following are included as pay items in the contract, they will be eligible for fuel price adjustment.

The pay items and the fuel factor used in calculating adjustments to be made will be as follows:

Description	Units	Fuel Usage Factor Diesel
Unclassified Excavation	Gal/CY	0.29
Borrow Excavation	Gal/CY	0.29
Class IV Subgrade Stabilization	Gal/Ton	0.55
Aggregate Base Course	Gal/Ton	0.55
Sub-Ballast	Gal/Ton	0.55
Asphalt Concrete Base Course, Type _____	Gal/Ton	2.90

Asphalt Concrete Intermediate Course, Type _____	Gal/Ton	2.90
Asphalt Concrete Surface Course, Type _____	Gal/Ton	2.90
Open-Graded Asphalt Friction Course	Gal/Ton	2.90
Permeable Asphalt Drainage Course, Type _____	Gal/Ton	2.90
Sand Asphalt Surface Course, Type _____	Gal/Ton	2.90
Aggregate for Cement Treated Base Course	Gal/Ton	0.55
Portland Cement for Cement Treated Base Course	Gal/Ton	0.55
" Portland Cement Concrete Pavement	Gal/SY	0.245
Concrete Shoulders Adjacent to ___ " Pavement	Gal/SY	0.245

SCHEDULE OF ESTIMATED COMPLETION PROGRESS:

(7-15-08) (Rev. 5-13-19)

108-2

SP1 G58

The Contractor's attention is directed to the Standard Special Provision entitled *Availability of Funds Termination of Contracts* included elsewhere in this proposal. The Department of Transportation's schedule of estimated completion progress for this project as required by that Standard Special Provision is as follows:

	<u>Fiscal Year</u>	<u>Progress (% of Dollar Value)</u>
2021	(7/01/20 - 6/30/21)	35% of Total Amount Bid
2022	(7/01/21 - 6/30/22)	37% of Total Amount Bid
2023	(7/01/22 - 6/30/23)	25% of Total Amount Bid
2024	(7/01/23 - 6/30/24)	3% of Total Amount Bid

The Contractor shall also furnish his own progress schedule in accordance with Article 108-2 of the *2018 Standard Specifications*. Any acceleration of the progress as shown by the Contractor's progress schedule over the progress as shown above shall be subject to the approval of the Engineer.

MINORITY BUSINESS ENTERPRISE AND WOMEN BUSINESS ENTERPRISE:

(10-16-07)(Rev. 12-17-19)

102-15(J)

SP1 G66

Description

The purpose of this Special Provision is to carry out the North Carolina Department of Transportation's policy of ensuring nondiscrimination in the award and administration of contracts financed in whole or in part with State funds.

Definitions

Additional MBE/WBE Subcontractors - Any MBE/WBE submitted at the time of bid that will not be used to meet the Combined MBE /WBE Goal. No submittal of a Letter of Intent is required.

Combined MBE/WBE Goal: A portion of the total contract, expressed as a percentage that is to be performed by committed MBE/WBE subcontractors.

Committed MBE/WBE Subcontractor - Any MBE/WBE submitted at the time of bid that is being used to meet the Combined MBE /WBE goal by submission of a Letter of Intent. Or any MBE or WBE used as a replacement for a previously committed MBE or WBE firm.

Contract Goal Requirement - The approved participation at time of award, but not greater than the advertised Combined MBE/WBE contract goal.

Goal Confirmation Letter - Written documentation from the Department to the bidder confirming the Contractor's approved, committed participation along with a listing of the committed MBE and WBE firms.

Manufacturer - A firm that operates or maintains a factory or establishment that produces on the premises, the materials or supplies obtained by the Contractor.

MBE Participation (Anticipated) - A portion of the total contract, expressed as a percentage that is anticipated to be performed by committed MBE subcontractor(s).

Minority Business Enterprise (MBE) - A firm certified as a Disadvantaged Minority-Owned Business Enterprise through the North Carolina Unified Certification Program.

Regular Dealer - A firm that owns, operates, or maintains a store, warehouse, or other establishment in which the materials or supplies required for the performance of the contract are bought, kept in stock, and regularly sold to the public in the usual course of business. A regular dealer engages in, as its principal business and in its own name, the purchase and sale or lease of the products in question. A regular dealer in such bulk items as steel, cement, gravel, stone, and petroleum products need not keep such products in stock, if it owns and operates distribution equipment for the products. Brokers and packagers are not regarded as manufacturers or regular dealers within the meaning of this section.

Replacement / Substitution – A full or partial reduction in the amount of work subcontracted to a committed (or an approved substitute) MBE/WBE firm.

North Carolina Unified Certification Program (NCUCP) - A program that provides comprehensive services and information to applicants for MBE/WBE certification. The MBE/WBE program follows the same regulations as the federal Disadvantaged Business Enterprise (DBE) program in accordance with 49 CFR Part 26.

United States Department of Transportation (USDOT) - Federal agency responsible for issuing regulations (49 CFR Part 26) and official guidance for the DBE program.

WBE Participation (Anticipated) - A portion of the total contract, expressed as a percentage, that is anticipated to be performed by committed WBE subcontractor(s).

Women Business Enterprise (WBE) - A firm certified as a Disadvantaged Women-Owned Business Enterprise through the North Carolina Unified Certification Program.

Forms and Websites Referenced in this Provision

Payment Tracking System - On-line system in which the Contractor enters the payments made to MBE and WBE subcontractors who have performed work on the project.
<https://apps.dot.state.nc.us/Vendor/PaymentTracking/>

DBE-IS Subcontractor Payment Information - Form for reporting the payments made to all MBE/WBE firms working on the project. This form is for paper bid projects only.
<https://connect.ncdot.gov/business/Turnpike/Documents/Form%20DBE-IS%20Subcontractor%20Payment%20Information.pdf>

RF-1 MBE/WBE Replacement Request Form - Form for replacing a committed MBE or WBE.
<http://connect.ncdot.gov/projects/construction/Construction%20Forms/DBE%20MBE%20WBE%20Replacement%20Request%20Form.pdf>

SAF Subcontract Approval Form - Form required for approval to sublet the contract.
<http://connect.ncdot.gov/projects/construction/Construction%20Forms/Subcontract%20Approval%20Form%20Rev.%202012.zip>

JC-1 Joint Check Notification Form - Form and procedures for joint check notification. The form acts as a written joint check agreement among the parties providing full and prompt disclosure of the expected use of joint checks.
<http://connect.ncdot.gov/projects/construction/Construction%20Forms/Joint%20Check%20Notification%20Form.pdf>

Letter of Intent - Form signed by the Contractor and the MBE/WBE subcontractor, manufacturer or regular dealer that affirms that a portion of said contract is going to be performed by the signed MBE/WBE for the estimated amount (based on quantities and unit prices) listed at the time of bid.
<http://connect.ncdot.gov/letting/LetCentral/Letter%20of%20Intent%20to%20Perform%20as%20a%20Subcontractor.pdf>

Listing of MBE and WBE Subcontractors Form - Form for entering MBE/WBE subcontractors on a project that will meet the Combined MBE/WBE goal. This form is for paper bids only.
[http://connect.ncdot.gov/municipalities/Bid%20Proposals%20for%20LGA%20Content/09%20MBE-WBE%20Subcontractors%20\(State\).docx](http://connect.ncdot.gov/municipalities/Bid%20Proposals%20for%20LGA%20Content/09%20MBE-WBE%20Subcontractors%20(State).docx)

Subcontractor Quote Comparison Sheet - Spreadsheet for showing all subcontractor quotes in the work areas where MBEs and WBEs quoted on the project. This sheet is submitted with good faith effort packages.
<http://connect.ncdot.gov/business/SmallBusiness/Documents/DBE%20Subcontractor%20Quote%20Comparison%20Example.xls>

Combined MBE/WBE Goal

The Combined MBE/WBE Goal for this project is **13.0 %**

The Combined Goal was established utilizing the following anticipated participation for Minority Business Enterprises and Women Business Enterprises:

(A) Minority Business Enterprises **7.0 %**

- (1) *If the anticipated MBE participation is more than zero*, the Contractor shall exercise all necessary and reasonable steps to ensure that MBEs participate in at least the percent of the contract as set forth above.
- (2) *If the anticipated MBE participation is zero*, the Contractor shall make an effort to recruit and use MBEs during the performance of the contract. Any MBE participation obtained shall be reported to the Department.

(B) Women Business Enterprises **6.0 %**

- (1) *If the anticipated WBE participation is more than zero*, the Contractor shall exercise all necessary and reasonable steps to ensure that WBEs participate in at least the percent of the contract as set forth above.
- (2) *If the anticipated WBE participation is zero*, the Contractor shall make an effort to recruit and use WBEs during the performance of the contract. Any WBE participation obtained shall be reported to the Department.

The Bidder is required to submit only participation to meet the Combined MBE/WBE Goal. The Combined Goal may be met by submitting all MBE participation, all WBE participation, or a combination of MBE and WBE participation.

Directory of Transportation Firms (Directory)

Real-time information is available about firms doing business with the Department and firms that are certified through NCUCP in the Directory of Transportation Firms. Only firms identified in the Directory as MBE and WBE certified shall be used to meet the Combined MBE/WBE Goal. The Directory can be found at the following link.

<https://www.ebs.nc.gov/VendorDirectory/default.html>

The listing of an individual firm in the directory shall not be construed as an endorsement of the firm's capability to perform certain work.

Listing of MBE/WBE Subcontractors

At the time of bid, bidders shall submit all MBE and WBE participation that they anticipate to use during the life of the contract. Only those identified to meet the Combined MBE/WBE Goal will be considered committed, even though the listing shall include both committed MBE/WBE subcontractors and additional MBE/WBE subcontractors. Any additional MBE/WBE

subcontractor participation above the goal will follow the banking guidelines found elsewhere in this provision. All other additional MBE/WBE subcontractor participation submitted at the time of bid will be used toward the Department's overall race-neutral goals. Only those firms with current MBE and WBE certification at the time of bid opening will be acceptable for listing in the bidder's submittal of MBE and WBE participation. The Contractor shall indicate the following required information:

(A) Electronic Bids

Bidders shall submit a listing of MBE and WBE participation in the appropriate section of the electronic submittal file.

- (1) Submit the names and addresses of MBE and WBE firms identified to participate in the contract. If the bidder uses the updated listing of MBE and WBE firms shown in the electronic submittal file, the bidder may use the dropdown menu to access the name and address of the firms.
- (2) Submit the contract line numbers of work to be performed by each MBE and WBE firm. When no figures or firms are entered, the bidder will be considered to have no MBE or WBE participation.
- (3) The bidder shall be responsible for ensuring that the MBE and WBE are certified at the time of bid by checking the Directory of Transportation Firms. If the firm is not certified at the time of the bid-letting, that MBE's or WBE's participation will not count towards achieving the Combined MBE/WBE goal.

(B) Paper Bids

- (1) *If the Combined MBE/WBE Goal is more than zero,*
 - (a) Bidders, at the time the bid proposal is submitted, shall submit a listing of MBE/WBE participation, including the names and addresses on *Listing of MBE and WBE Subcontractors* contained elsewhere in the contract documents in order for the bid to be considered responsive. Bidders shall indicate the total dollar value of the MBE and WBE participation for the contract.
 - (b) If bidders have no MBE or WBE participation, they shall indicate this on the *Listing of MBE and WBE Subcontractors* by entering the word "None" or the number "0." This form shall be completed in its entirety. **Blank forms will not be deemed to represent zero participation.** Bids submitted that do not have MBE and WBE participation indicated on the appropriate form will not be read publicly during the opening of bids. The Department will not consider these bids for award and the proposal will be rejected.
 - (c) The bidder shall be responsible for ensuring that the MBE/WBE is certified at the time of bid by checking the Directory of Transportation Firms. If the

firm is not certified at the time of the bid-letting, that MBE's or WBE's participation will not count towards achieving the Combined MBE/WBE Goal.

- (2) *If the Combined MBE/WBE Goal is zero, entries on the Listing of MBE and WBE Subcontractors are not required for the zero goal, however any MBE or WBE participation that is achieved during the project shall be reported in accordance with requirements contained elsewhere in the special provision.*

MBE or WBE Prime Contractor

When a certified MBE or WBE firm bids on a contract that contains a Combined MBE/WBE goal, the firm is responsible for meeting the goal or making good faith efforts to meet the goal, just like any other bidder. In most cases, a MBE or WBE bidder on a contract will meet the Combined MBE/WBE Goal by virtue of the work it performs on the contract with its own forces. However, all the work that is performed by the MBE or WBE bidder and any other similarly certified subcontractors will count toward the goal. The MBE or WBE bidder shall list itself along with any MBE or WBE subcontractors, if any, in order to receive credit toward the goal.

MBE/WBE prime contractors shall also follow Sections A and B listed under *Listing of MBE/WBE Subcontractor* just as a non-MBE/WBE bidder would.

Written Documentation – Letter of Intent

The bidder shall submit written documentation for each MBE/WBE that will be used to meet the Combined MBE/WBE Goal of the contract, indicating the bidder's commitment to use the MBE/WBE in the contract. This documentation shall be submitted on the Department's form titled *Letter of Intent*.

The documentation shall be received in the office of the State Contractor Utilization Engineer or at DBE@ncdot.gov no later than 10:00 a.m. of the sixth calendar day following opening of bids, unless the sixth day falls on an official state holiday. In that situation, it is due in the office of the State Contractor Utilization Engineer no later than 10:00 a.m. on the next official state business day.

If the bidder fails to submit the Letter of Intent from each committed MBE and WBE to be used toward the Combined MBE/WBE Goal, or if the form is incomplete (i.e. both signatures are not present), the MBE/WBE participation will not count toward meeting the Combined MBE/WBE Goal. If the lack of this participation drops the commitment below the Combined MBE/WBE Goal, the Contractor shall submit evidence of good faith efforts for the goal, completed in its entirety, to the State Contractor Utilization Engineer or DBE@ncdot.gov no later than 10:00 a.m. on the eighth calendar day following opening of bids, unless the eighth day falls on an official state holiday. In that situation, it is due in the office of the State Contractor Utilization Engineer no later than 10:00 a.m. on the next official state business day.

Banking MBE/WBE Credit

If the bid of the lowest responsive bidder exceeds \$500,000 and if the committed MBE/WBE participation submitted exceeds the algebraic sum of the Combined MBE /WBE Goal by \$1,000 or more, the excess will be placed on deposit by the Department for future use by the bidder. Separate accounts will be maintained for MBE and WBE participation and these may accumulate for a period not to exceed 24 months.

When the apparent lowest responsive bidder fails to submit sufficient participation by MBE and WBE firms to meet the advertised goal, as part of the good faith effort, the Department will consider allowing the bidder to withdraw funds to meet the Combined MBE/WBE Goal as long as there are adequate funds available from the bidder's MBE and WBE bank accounts.

Submission of Good Faith Effort

If the bidder fails to meet or exceed the Combined MBE/WBE Goal, the apparent lowest responsive bidder shall submit to the Department documentation of adequate good faith efforts made to reach that specific goal.

A hard copy and an electronic copy of this information shall be received in the office of the State Contractor Utilization Engineer or at DBE@ncdot.gov no later than 10:00 a.m. on the sixth calendar day following opening of bids unless the sixth day falls on an official state holiday. In that situation, it would be due in the office of the State Contractor Utilization Engineer no later than 10:00 a.m. on the next official state business day. If the contractor cannot send the information electronically, then one complete set and 5 copies of this information shall be received under the same time constraints above.

Note: Where the information submitted includes repetitious solicitation letters, it will be acceptable to submit a representative letter along with a distribution list of the firms that were solicited. Documentation of MBE/WBE quotations shall be a part of the good faith effort submittal. This documentation may include written subcontractor quotations, telephone log notations of verbal quotations, or other types of quotation documentation.

Consideration of Good Faith Effort for Projects with a Combined MBE/WBE Goal More Than Zero

Adequate good faith efforts mean that the bidder took all necessary and reasonable steps to achieve the goal which, by their scope, intensity, and appropriateness, could reasonably be expected to obtain sufficient MBE/WBE participation. Adequate good faith efforts also mean that the bidder actively and aggressively sought MBE/WBE participation. Mere *pro forma* efforts are not considered good faith efforts.

The Department will consider the quality, quantity, and intensity of the different kinds of efforts a bidder has made. Listed below are examples of the types of actions a bidder will take in making a good faith effort to meet the goals and are not intended to be exclusive or exhaustive, nor is it intended to be a mandatory checklist.

- (A) Soliciting through all reasonable and available means (e.g. attendance at pre-bid meetings, advertising, written notices, use of verifiable electronic means through the use of the

NCDOT Directory of Transportation Firms) the interest of all certified MBEs/WBEs that are also prequalified subcontractors. The bidder must solicit this interest within at least 10 days prior to bid opening to allow the MBEs/WBEs to respond to the solicitation. Solicitation shall provide the opportunity to MBEs/WBEs within the Division and surrounding Divisions where the project is located. The bidder must determine with certainty if the MBEs/WBEs are interested by taking appropriate steps to follow up initial solicitations.

- (B) Selecting portions of the work to be performed by MBEs/WBEs in order to increase the likelihood that the Combined MBE/WBE Goal will be achieved.
 - (1) Where appropriate, break out contract work items into economically feasible units to facilitate MBE/WBE participation, even when the prime contractor might otherwise prefer to perform these work items with its own forces.
 - (2) Negotiate with subcontractors to assume part of the responsibility to meet the advertised goal when the work to be sublet includes potential for MBE/WBE participation (2nd and 3rd tier subcontractors).
- (C) Providing interested certified MBEs/WBEs that are also prequalified subcontractors with adequate information about the plans, specifications, and requirements of the contract in a timely manner to assist them in responding to a solicitation.
- (D)
 - (1) Negotiating in good faith with interested MBEs/WBEs. It is the bidder's responsibility to make a portion of the work available to MBE/WBE subcontractors and suppliers and to select those portions of the work or material needs consistent with the available MBE/WBE subcontractors and suppliers, so as to facilitate MBE/WBE participation. Evidence of such negotiation includes the names, addresses, and telephone numbers of MBEs/WBEs that were considered; a description of the information provided regarding the plans and specifications for the work selected for subcontracting; and evidence as to why additional agreements could not be reached for MBEs/WBEs to perform the work.
 - (2) A bidder using good business judgment would consider a number of factors in negotiating with subcontractors, including MBE/WBE subcontractors, and would take a firm's price and capabilities as well as the advertised goal into consideration. However, the fact that there may be some additional costs involved in finding and using MBEs/WBEs is not in itself sufficient reason for a bidder's failure to meet the contract goal, as long as such costs are reasonable. Also, the ability or desire of a prime contractor to perform the work of a contract with its own organization does not relieve the bidder of the responsibility to make good faith efforts. Bidding contractors are not, however, required to accept higher quotes from MBEs/WBEs if the price difference is excessive or unreasonable.
- (E) Not rejecting MBEs/WBEs as being unqualified without sound reasons based on a thorough investigation of their capabilities. The bidder's standing within its industry, membership in specific groups, organizations, or associates and political or social

affiliations (for example, union vs. non-union employee status) are not legitimate causes for the rejection or non-solicitation of bids in the bidder's efforts to meet the project goal.

- (F) Making efforts to assist interested MBEs/WBEs in obtaining bonding, lines of credit, or insurance as required by the recipient or bidder.
- (G) Making efforts to assist interested MBEs/WBEs in obtaining necessary equipment, supplies, materials, or related assistance or services.
- (H) Effectively using the services of available minority/women community organizations; minority/women contractors' groups; Federal, State, and local minority/women business assistance offices; and other organizations as allowed on a case-by-case basis to provide assistance in the recruitment and placement of MBEs/WBEs. Contact within 7 days from the bid opening the Business Opportunity and Work Force Development Unit at BOWD@ncdot.gov to give notification of the bidder's inability to get MBE or WBE quotes.
- (I) Any other evidence that the bidder submits which shows that the bidder has made reasonable good faith efforts to meet the advertised goal.

In addition, the Department may take into account the following:

- (1) Whether the bidder's documentation reflects a clear and realistic plan for achieving the Combined MBE/WBE Goal.
- (2) The bidders' past performance in meeting the contract goal.
- (3) The performance of other bidders in meeting the advertised goal. For example, when the apparent successful bidder fails to meet the goal, but others meet it, you may reasonably raise the question of whether, with additional reasonable efforts the apparent successful bidder could have met the goal. If the apparent successful bidder fails to meet the advertised goal, but meets or exceeds the average MBE and WBE participation obtained by other bidders, the Department may view this, in conjunction with other factors, as evidence of the apparent successful bidder having made a good faith effort.

If the Department does not award the contract to the apparent lowest responsive bidder, the Department reserves the right to award the contract to the next lowest responsive bidder that can satisfy to the Department that the Combined MBE/WBE Goal can be met or that an adequate good faith effort has been made to meet the advertised goal.

Non-Good Faith Appeal

The State Prequalification Engineer will notify the contractor verbally and in writing of non-good faith. A contractor may appeal a determination of non-good faith made by the Goal Compliance Committee. If a contractor wishes to appeal the determination made by the Committee, they shall provide written notification to the State Prequalification Engineer or at DBE@ncdot.gov. The appeal shall be made within 2 business days of notification of the determination of non-good faith.

Counting MBE/WBE Participation Toward Meeting the Combined MBE/WBE Goal**(A) Participation**

The total dollar value of the participation by a committed MBE/WBE will be counted toward the contract goal requirements. The total dollar value of participation by a committed MBE/WBE will be based upon the value of work actually performed by the MBE/WBE and the actual payments to MBE/WBE firms by the Contractor.

(B) Joint Checks

Prior notification of joint check use shall be required when counting MBE/WBE participation for services or purchases that involves the use of a joint check. Notification shall be through submission of Form JC-1 (*Joint Check Notification Form*) and the use of joint checks shall be in accordance with the Department's Joint Check Procedures.

(C) Subcontracts (Non-Trucking)

A MBE/WBE may enter into subcontracts. Work that a MBE subcontracts to another MBE firm may be counted toward the anticipated MBE participation. The same holds true for work that a WBE subcontracts to another WBE firm. Work that a MBE/WBE subcontracts to a non-MBE/WBE firm does not count toward the contract goal requirement. It should be noted that every effort shall be made by MBE and WBE contractors to subcontract to the same certification (i.e., MBEs to MBEs and WBEs to WBEs), in order to fulfill the MBE or WBE participation breakdown. This, however, may not always be possible due to the limitation of firms in the area. If the MBE or WBE firm shows a good faith effort has been made to reach out to similarly certified firms and there is no interest or availability, and they can get assistance from other certified firms, the Engineer will not hold the prime responsible for meeting the individual MBE or WBE breakdown. If a MBE or WBE contractor or subcontractor subcontracts a significantly greater portion of the work of the contract than would be expected on the basis of standard industry practices, it shall be presumed that the MBE or WBE is not performing a commercially useful function.

(D) Joint Venture

When a MBE or WBE performs as a participant in a joint venture, the Contractor may count toward its contract goal requirement a portion of the total value of participation with the MBE or WBE in the joint venture, that portion of the total dollar value being a distinct clearly defined portion of work that the MBE or WBE performs with its forces.

(E) Suppliers

A contractor may count toward its MBE/ WBE requirement 60 percent of its expenditures for materials and supplies required to complete the contract and obtained from a MBE or WBE regular dealer and 100 percent of such expenditures from a MBE or WBE manufacturer.

(F) Manufacturers and Regular Dealers

A contractor may count toward its MBE/ WBE requirement the following expenditures to MBE/WBE firms that are not manufacturers or regular dealers:

- (1) The fees or commissions charged by a MBE/WBE firm for providing a *bona fide* service, such as professional, technical, consultant, or managerial services, or for providing bonds or insurance specifically required for the performance of a DOT-assisted contract, provided the fees or commissions are determined to be reasonable and not excessive as compared with fees and commissions customarily allowed for similar services.
- (2) With respect to materials or supplies purchased from a MBE/WBE, which is neither a manufacturer nor a regular dealer, count the entire amount of fees or commissions charged for assistance in the procurement of the materials and supplies, or fees or transportation charges for the delivery of materials or supplies required on a job site (but not the cost of the materials and supplies themselves), provided the fees are determined to be reasonable and not excessive as compared with fees customarily allowed for similar services.

Commercially Useful Function

(A) MBE/WBE Utilization

The Contractor may count toward its contract goal requirement only expenditures to MBEs and WBEs that perform a commercially useful function in the work of a contract. A MBE/WBE performs a commercially useful function when it is responsible for execution of the work of the contract and is carrying out its responsibilities by actually performing, managing, and supervising the work involved. To perform a commercially useful function, the MBE/WBE shall also be responsible with respect to materials and supplies used on the contract, for negotiating price, determining quality and quantity, ordering the material and installing (where applicable) and paying for the material itself. To determine whether a MBE/WBE is performing a commercially useful function, the Department will evaluate the amount of work subcontracted, industry practices, whether the amount the firm is to be paid under the contract is commensurate with the work it is actually performing and the MBE/WBE credit claimed for its performance of the work, and any other relevant factors. If it is determined that a MBE or WBE is not performing a Commercially Useful Function, the contractor may present evidence to rebut this presumption to the Department.

(B) MBE/WBE Utilization in Trucking

The following factors will be used to determine if a MBE or WBE trucking firm is performing a commercially useful function:

- (1) The MBE/WBE shall be responsible for the management and supervision of the entire trucking operation for which it is responsible on a particular contract, and there shall not be a contrived arrangement for the purpose of meeting the Combined MBE/WBE Goal.
- (2) The MBE/WBE shall itself own and operate at least one fully licensed, insured, and operational truck used on the contract.
- (3) The MBE/WBE receives credit for the total value of the transportation services it provides on the contract using trucks it owns, insures, and operates using drivers it employs.
- (4) The MBE may subcontract the work to another MBE firm, including an owner-operator who is certified as a MBE. The same holds true that a WBE may subcontract the work to another WBE firm, including an owner-operator who is certified as a WBE. When this occurs, the MBE or WBE who subcontracts work receives credit for the total value of the transportation services the subcontracted MBE or WBE provides on the contract. It should be noted that every effort shall be made by MBE and WBE contractors to subcontract to the same certification (i.e., MBEs to MBEs and WBEs to WBEs), in order to fulfill the participation breakdown. This, however, may not always be possible due to the limitation of firms in the area. If the MBE or WBE firm shows a good faith effort has been made to reach out to similarly certified transportation service providers and there is no interest or availability, and they can get assistance from other certified providers, the Engineer will not hold the prime responsible for meeting the individual MBE or WBE participation breakdown.
- (5) The MBE/WBE may also subcontract the work to a non-MBE/WBE firm, including from an owner-operator. The MBE/WBE who subcontracts the work to a non-MBE/WBE is entitled to credit for the total value of transportation services provided by the non-MBE/WBE subcontractor not to exceed the value of transportation services provided by MBE/WBE-owned trucks on the contract. Additional participation by non-MBE/WBE subcontractors receives credit only for the fee or commission it receives as a result of the subcontract arrangement. The value of services performed under subcontract agreements between the MBE/WBE and the Contractor will not count towards the MBE/WBE contract requirement.
- (6) A MBE/WBE may lease truck(s) from an established equipment leasing business open to the general public. The lease must indicate that the MBE/WBE has exclusive use of and control over the truck. This requirement does not preclude the leased truck from working for others during the term of the lease with the consent of the MBE/WBE, so long as the lease gives the MBE/WBE absolute priority for

use of the leased truck. This type of lease may count toward the MBE/WBE's credit as long as the driver is under the MBE/WBE's payroll.

- (7) Subcontracted/leased trucks shall display clearly on the dashboard the name of the MBE/WBE that they are subcontracted/leased to and their own company name if it is not identified on the truck itself. Magnetic door signs are not permitted.

MBE/WBE Replacement

When a Contractor has relied on a commitment to a MBE or WBE subcontractor (or an approved substitute MBE or WBE subcontractor) to meet all or part of a contract goal requirement, the contractor shall not terminate the MBE/WBE subcontractor for convenience. This includes, but is not limited to, instances in which the Contractor seeks to perform the work of the terminated subcontractor with another MBE/WBE subcontractor, a non-MBE/WBE subcontractor, or with the Contractor's own forces or those of an affiliate.

The Contractor must give notice in writing both by certified mail and email to the MBE/WBE subcontractor, with a copy to the Engineer of its intent to request to terminate and/or substitute, and the reason for the request. The Contractor must give the MBE/WBE subcontractor five (5) business days to respond to the Contractor's Notice of Intent to Request Termination and/or Substitution. If the MBE/WBE subcontractor objects to the intended termination/substitution, the MBE/WBE, within five (5) business days must advise the Contractor and the Department of the reasons why the action should not be approved. The five-day notice period shall begin on the next business day after written notice is provided to the MBE/WBE subcontractor.

A committed MBE/WBE subcontractor may only be terminated after receiving the Department's written approval based upon a finding of good cause for the proposed termination and/or substitution. For purposes of this section, good cause shall include the following circumstances:

- (a) The listed MBE/WBE subcontractor fails or refuses to execute a written contract;
- (b) The listed MBE/WBE subcontractor fails or refuses to perform the work of its subcontract in a way consistent with normal industry standards. Provided, however, that good cause does not exist if the failure or refusal of the MBE/WBE subcontractor to perform its work on the subcontract results from the bad faith or discriminatory action of the prime contractor;
- (c) The listed MBE/WBE subcontractor fails or refuses to meet the prime contractor's reasonable, nondiscriminatory bond requirements;
- (d) The listed MBE/WBE subcontractor becomes bankrupt, insolvent, or exhibits credit unworthiness;
- (e) The listed MBE/WBE subcontractor is ineligible to work on public works projects because of suspension and debarment proceedings pursuant to 2 CFR Parts 180, 215 and 1,200 or applicable state law;
- (f) The listed MBE/WBE subcontractor is not a responsible contractor;
- (g) The listed MBE/WBE voluntarily withdraws from the project and provides written notice of withdrawal;
- (h) The listed MBE/WBE is ineligible to receive MBE/WBE credit for the type of work required;

- (i) A MBE/WBE owner dies or becomes disabled with the result that the listed MBE/WBE contractor is unable to complete its work on the contract;
- (j) Other documented good cause that compels the termination of the MBE/WBE subcontractor. Provided, that good cause does not exist if the prime contractor seeks to terminate a MBE/WBE it relied upon to obtain the contract so that the prime contractor can self-perform the work for which the MBE/WBE contractor was engaged or so that the prime contractor can substitute another MBE/WBE or non-MBE/WBE contractor after contract award.

The Contractor shall comply with the following for replacement of a committed MBE/WBE:

(A) Performance Related Replacement

When a committed MBE/WBE is terminated for good cause as stated above, an additional MBE/WBE that was submitted at the time of bid may be used to fulfill the MBE/WBE commitment to meet the Combined MBE/WBE Goal. A good faith effort will only be required for removing a committed MBE/WBE if there were no additional MBE/WBEs submitted at the time of bid to cover the same amount of work as the MBE/WBE that was terminated.

If a replacement MBE/WBE is not found that can perform at least the same amount of work as the terminated MBE/WBE, the Contractor shall submit a good faith effort documenting the steps taken. Such documentation shall include, but not be limited to, the following:

- (1) Copies of written notification to MBE/WBEs that their interest is solicited in contracting the work defaulted by the previous MBE/WBE or in subcontracting other items of work in the contract.
- (2) Efforts to negotiate with MBE/WBEs for specific subbids including, at a minimum:
 - (a) The names, addresses, and telephone numbers of MBE/WBEs who were contacted.
 - (b) A description of the information provided to MBE/WBEs regarding the plans and specifications for portions of the work to be performed.
- (3) A list of reasons why MBE/WBE quotes were not accepted.
- (4) Efforts made to assist the MBE/WBEs contacted, if needed, in obtaining bonding or insurance required by the Contractor.

(B) Decertification Replacement

- (1) When a committed MBE/WBE is decertified by the Department after the SAF (*Subcontract Approval Form*) has been received by the Department, the Department will not require the Contractor to solicit replacement MBE/WBE participation equal to the remaining work to be performed by the decertified firm. The participation equal to the remaining work performed by the decertified firm will count toward the contract goal requirement.

- (2) When a committed MBE/WBE is decertified prior to the Department receiving the SAF (*Subcontract Approval Form*) for the named MBE/WBE firm, the Contractor shall take all necessary and reasonable steps to replace the MBE/WBE subcontractor with another MBE/WBE subcontractor to perform at least the same amount of work to meet the Combined MBE/WBE goal requirement. If a MBE/WBE firm is not found to do the same amount of work, a good faith effort must be submitted to NCDOT (see A herein for required documentation).

All requests for replacement of a committed MBE/WBE firm shall be submitted to the Engineer for approval on Form RF-1 (*DBE Replacement Request*). If the Contractor fails to follow this procedure, the Contractor may be disqualified from further bidding for a period of up to 6 months.

Changes in the Work

When the Engineer makes changes that result in the reduction or elimination of work to be performed by a committed MBE/WBE, the Contractor will not be required to seek additional participation. When the Engineer makes changes that result in additional work to be performed by a MBE/WBE based upon the Contractor's commitment, the MBE/WBE shall participate in additional work to the same extent as the MBE/WBE participated in the original contract work.

When the Engineer makes changes that result in extra work, which has more than a minimal impact on the contract amount, the Contractor shall seek additional participation by MBEs/WBEs unless otherwise approved by the Engineer.

When the Engineer makes changes that result in an alteration of plans or details of construction, and a portion or all of the work had been expected to be performed by a committed MBE/WBE, the Contractor shall seek participation by MBEs/WBEs unless otherwise approved by the Engineer.

When the Contractor requests changes in the work that result in the reduction or elimination of work that the Contractor committed to be performed by a MBE/WBE, the Contractor shall seek additional participation by MBEs/WBEs equal to the reduced MBE/WBE participation caused by the changes.

Reports and Documentation

A SAF (*Subcontract Approval Form*) shall be submitted for all work which is to be performed by a MBE/WBE subcontractor. The Department reserves the right to require copies of actual subcontract agreements involving MBE/WBE subcontractors.

When using transportation services to meet the contract commitment, the Contractor shall submit a proposed trucking plan in addition to the SAF. The plan shall be submitted prior to beginning construction on the project. The plan shall include the names of all trucking firms proposed for use, their certification type(s), the number of trucks owned by the firm, as well as the individual truck identification numbers, and the line item(s) being performed.

Within 30 calendar days of entering into an agreement with a MBE/WBE for materials, supplies or services, not otherwise documented by the SAF as specified above, the Contractor shall furnish the Engineer a copy of the agreement. The documentation shall also indicate the percentage (60% or 100%) of expenditures claimed for MBE/WBE credit.

Reporting Minority and Women Business Enterprise Participation

The Contractor shall provide the Engineer with an accounting of payments made to all MBE/WBE firms, including material suppliers and contractors at all levels (prime, subcontractor, or second tier subcontractor). This accounting shall be furnished to the Engineer for any given month by the end of the following month. Failure to submit this information accordingly may result in the following action:

- (A) Withholding of money due in the next partial pay estimate; or
- (B) Removal of an approved contractor from the prequalified bidders' list or the removal of other entities from the approved subcontractors list.

While each contractor (prime, subcontractor, 2nd tier subcontractor) is responsible for accurate accounting of payments to MBEs/WBEs, it shall be the prime contractor's responsibility to report all monthly and final payment information in the correct reporting manner.

Failure on the part of the Contractor to submit the required information in the time frame specified may result in the disqualification of that contractor and any affiliate companies from further bidding until the required information is submitted.

Failure on the part of any subcontractor to submit the required information in the time frame specified may result in the disqualification of that contractor and any affiliate companies from being approved for work on future DOT projects until the required information is submitted.

Contractors reporting transportation services provided by non-MBE/WBE lessees shall evaluate the value of services provided during the month of the reporting period only.

At any time, the Engineer can request written verification of subcontractor payments.

The Contractor shall report the accounting of payments through the Department's Payment Tracking System.

Failure to Meet Contract Requirements

Failure to meet contract requirements in accordance with Subarticle 102-15(J) of the *2018 Standard Specifications* may be cause to disqualify the Contractor.

CONTRACTOR'S LICENSE REQUIREMENTS:

(7-1-95)

102-14

SP1 G88

If the successful bidder does not hold the proper license to perform any plumbing, heating, air conditioning, or electrical work in this contract, he will be required to sublet such work to a contractor properly licensed in accordance with *Article 2 of Chapter 87 of the General Statutes* (licensing of heating, plumbing, and air conditioning contractors) and *Article 4 of Chapter 87 of the General Statutes* (licensing of electrical contractors).

USE OF UNMANNED AIRCRAFT SYSTEM (UAS):

(8-20-19)

SP1 G092

The Contractor shall adhere to all Federal, State and Local regulations and guidelines for the use of Unmanned Aircraft Systems (UAS). This includes but is not limited to US 14 CFR Part 107 *Small UAS Rule*, NC GS 15A-300.2 *Regulation of launch and recovery sites*, NC GS 63-95 *Training required for the operation of unmanned aircraft systems*, NC GS 63-96 *Permit required for commercial operation of unmanned aircraft system*, and NCDOT UAS Policy. The required operator certifications include possessing a current Federal Aviation Administration (FAA) Remote Pilot Certificate, a NC UAS Operator Permit as well as operating a UAS registered with the FAA.

Prior to beginning operations, the Contractor shall complete the NCDOT UAS – Flight Operation Approval Form and submit it to the Engineer for approval. All UAS operations shall be approved by the Engineer prior to beginning the operations.

All contractors or subcontractors operating UAS shall have UAS specific general liability insurance to cover all operations under this contract.

The use of UAS is at the Contractor's discretion. No measurement or payment will be made for the use of UAS. In the event that the Department directs the Contractor to utilize UAS, payment will be in accordance with Article 104-7 Extra Work.

SUBSURFACE INFORMATION:

(7-1-95)

450

SP1 G112 B

Subsurface information is available on the roadway portion of this project only.

MAINTENANCE OF THE PROJECT:

(11-20-07) (Rev. 1-17-12)

104-10

SP1 G125

Revise the *2018 Standard Specifications* as follows:

Page 1-39, Article 104-10 Maintenance of the Project, line 25, add the following after the first sentence of the first paragraph:

All guardrail/guiderail within the project limits shall be included in this maintenance.

Page 1-39, Article 104-10 Maintenance of the Project, line 30, add the following as the last sentence of the first paragraph:

The Contractor shall perform weekly inspections of guardrail and guiderail and shall report damages to the Engineer on the same day of the weekly inspection. *Where damaged guardrail or guiderail is repaired or replaced as a result of maintaining the project in accordance with this article, such repair or replacement shall be performed within 7 consecutive calendar days of such inspection report.*

Page 1-39, Article 104-10 Maintenance of the Project, lines 42-44, replace the last sentence of the last paragraph with the following:

The Contractor will not be directly compensated for any maintenance operations necessary, except for maintenance of guardrail/guiderail, as this work will be considered incidental to the work covered by the various contract items. The provisions of Article 104-7, Extra Work, and Article 104-8, Compensation and Record Keeping will apply to authorized maintenance of guardrail/guiderail. Performance of weekly inspections of guardrail/guiderail, and the damage reports required as described above, will be considered to be an incidental part of the work being paid for by the various contract items.

ELECTRONIC BIDDING:

(2-19-19)

101, 102, 103

SP1 G140

Revise the *2018 Standard Specifications* as follows:

Page 1-4, Article 101-3, DEFINITIONS, BID (OR PROPOSAL) *Electronic Bid*, line 1, replace “Bid Express®” with “the approved electronic bidding provider”.

Page 1-15, Subarticle 102-8(B), *Electronic Bids*, lines 39-40, replace “to Bid Express®” with “via the approved electronic bidding provider”.

Page 1-15, Subarticle 102-8(B)(1), *Electronic Bids*, line 41, delete “from Bid Express®”

Page 1-17, Subarticle 102-9(C)(2), *Electronic Bids*, line 21, replace “Bid Express® miscellaneous folder within the .ebs” with “electronic submittal”.

Page 1-29, Subarticle 103-4(C)(2), *Electronic Bids*, line 32, replace “.ebs miscellaneous data file of Expedite” with “electronic submittal file”

TWELVE MONTH GUARANTEE:

(7-15-03)

108

SP1 G145

- (A) The Contractor shall guarantee materials and workmanship against latent and patent defects arising from faulty materials, faulty workmanship or negligence for a period of twelve months following the date of final acceptance of the work for maintenance and shall replace such defective materials and workmanship without cost to the Department. The Contractor will not be responsible for damage due to faulty design, normal wear and tear, for negligence on the part of the Department, and/or for use in excess of the design.
- (B) Where items of equipment or material carry a manufacturer’s guarantee for any period in excess of twelve months, then the manufacturer’s guarantee shall apply for that particular piece of equipment or material. The Department’s first remedy shall be through the

manufacturer although the Contractor is responsible for invoking the warranted repair work with the manufacturer. The Contractor's responsibility shall be limited to the term of the manufacturer's guarantee. NCDOT would be afforded the same warranty as provided by the Manufacturer.

This guarantee provision shall be invoked only for major components of work in which the Contractor would be wholly responsible for under the terms of the contract. Examples would include pavement structures, bridge components, and sign structures. This provision will not be used as a mechanism to force the Contractor to return to the project to make repairs or perform additional work that the Department would normally compensate the Contractor for. In addition, routine maintenance activities (i.e. mowing grass, debris removal, ruts in earth shoulders,) are not parts of this guarantee.

Appropriate provisions of the payment and/or performance bonds shall cover this guarantee for the project.

To ensure uniform application statewide the Division Engineer will forward details regarding the circumstances surrounding any proposed guarantee repairs to the Chief Engineer for review and approval prior to the work being performed.

OUTSOURCING OUTSIDE THE USA:

(9-21-04) (Rev. 5-16-06)

SP1 G150

All work on consultant contracts, services contracts, and construction contracts shall be performed in the United States of America. No work shall be outsourced outside of the United States of America.

Outsourcing for the purpose of this provision is defined as the practice of subcontracting labor, work, services, staffing, or personnel to entities located outside of the United States.

The North Carolina Secretary of Transportation shall approve exceptions to this provision in writing.

EROSION AND SEDIMENT CONTROL/STORMWATER CERTIFICATION:

(1-16-07) (Rev 04-01-19)

105-16, 225-2, 16

SP1 G180

General

Schedule and conduct construction activities in a manner that will minimize soil erosion and the resulting sedimentation and turbidity of surface waters. Comply with the requirements herein regardless of whether or not a National Pollution discharge Elimination System (NPDES) permit for the work is required.

Establish a chain of responsibility for operations and subcontractors' operations to ensure that the *Erosion and Sediment Control/Stormwater Pollution Prevention Plan* is implemented and maintained over the life of the contract.

- (A) *Certified Supervisor* - Provide a certified Erosion and Sediment Control/Stormwater Supervisor to manage the Contractor and subcontractor operations, insure compliance with

Federal, State and Local ordinances and regulations, and manage the Quality Control Program.

- (B) *Certified Foreman* - Provide a certified, trained foreman for each construction operation that increases the potential for soil erosion or the possible sedimentation and turbidity of surface waters.
- (C) *Certified Installer* - Provide a certified installer to install or direct the installation for erosion or sediment/stormwater control practices.
- (D) *Certified Designer* - Provide a certified designer for the design of the erosion and sediment control/stormwater component of reclamation plans and, if applicable, for the design of the project erosion and sediment control/stormwater plan.

Roles and Responsibilities

- (A) *Certified Erosion and Sediment Control/Stormwater Supervisor* - The Certified Supervisor shall be Level II and responsible for ensuring the erosion and sediment control/stormwater plan is adequately implemented and maintained on the project and for conducting the quality control program. The Certified Supervisor shall be on the project within 24 hours notice from initial exposure of an erodible surface to the project's final acceptance. Perform the following duties:
 - (1) **Manage Operations** - Coordinate and schedule the work of subcontractors so that erosion and sediment control/stormwater measures are fully executed for each operation and in a timely manner over the duration of the contract.
 - (a) Oversee the work of subcontractors so that appropriate erosion and sediment control/stormwater preventive measures are conformed to at each stage of the work.
 - (b) Prepare the required National Pollutant Discharge Elimination System (NPDES) Inspection Record and submit to the Engineer.
 - (c) Attend all weekly or monthly construction meetings to discuss the findings of the NPDES inspection and other related issues.
 - (d) Implement the erosion and sediment control/stormwater site plans requested.
 - (e) Provide any needed erosion and sediment control/stormwater practices for the Contractor's temporary work not shown on the plans, such as, but not limited to work platforms, temporary construction, pumping operations, plant and storage yards, and cofferdams.
 - (f) Acquire applicable permits and comply with requirements for borrow pits, dewatering, and any temporary work conducted by the Contractor in jurisdictional areas.
 - (g) Conduct all erosion and sediment control/stormwater work in a timely and workmanlike manner.
 - (h) Fully perform and install erosion and sediment control/stormwater work prior to any suspension of the work.

- (i) Coordinate with Department, Federal, State and Local Regulatory agencies on resolution of erosion and sediment control/stormwater issues due to the Contractor's operations.
 - (j) Ensure that proper cleanup occurs from vehicle tracking on paved surfaces or any location where sediment leaves the Right-of-Way.
 - (k) Have available a set of erosion and sediment control/stormwater plans that are initialed and include the installation date of Best Management Practices. These practices shall include temporary and permanent groundcover and be properly updated to reflect necessary plan and field changes for use and review by Department personnel as well as regulatory agencies.
- (2) Requirements set forth under the NPDES Permit - The Department's NPDES Stormwater permit (NCS000250) outlines certain objectives and management measures pertaining to construction activities. The permit references *NCG010000, General Permit to Discharge Stormwater* under the NPDES, and states that the Department shall incorporate the applicable requirements into its delegated Erosion and Sediment Control Program for construction activities disturbing one or more acres of land. The Department further incorporates these requirements on all contracted bridge and culvert work at jurisdictional waters, regardless of size. Some of the requirements are, but are not limited to:
- (a) Control project site waste to prevent contamination of surface or ground waters of the state, i.e. from equipment operation/maintenance, construction materials, concrete washout, chemicals, litter, fuels, lubricants, coolants, hydraulic fluids, any other petroleum products, and sanitary waste.
 - (b) Inspect erosion and sediment control/stormwater devices and stormwater discharge outfalls at least once every 7 calendar days and within 24 hours after a rainfall event of greater than 1.0 inch that occurs within a 24 hour period. Additional monitoring may be required at the discretion of Division of Water Resources personnel if the receiving stream is 303(d) listed for turbidity and the project has had documented problems managing turbidity.
 - (c) Maintain an onsite rain gauge or use the Department's Multi-Sensor Precipitation Estimate website to maintain a daily record of rainfall amounts and dates.
 - (d) Maintain erosion and sediment control/stormwater inspection records for review by Department and Regulatory personnel upon request.
 - (e) Implement approved reclamation plans on all borrow pits, waste sites and staging areas.
 - (f) Maintain a log of turbidity test results as outlined in the Department's Procedure for Monitoring Borrow Pit Discharge.
 - (g) Provide secondary containment for bulk storage of liquid materials.
 - (h) Provide training for employees concerning general erosion and sediment control/stormwater awareness, the Department's NPDES Stormwater Permit NCS000250 requirements, and the applicable requirements of the *General Permit, NCG010000*.
 - (i) Report violations of the NPDES permit to the Engineer immediately who will notify the Division of Water Quality Regional Office within 24 hours of becoming aware of the violation.

- (3) Quality Control Program - Maintain a quality control program to control erosion, prevent sedimentation and follow provisions/conditions of permits. The quality control program shall:
- (a) Follow permit requirements related to the Contractor and subcontractors' construction activities.
 - (b) Ensure that all operators and subcontractors on site have the proper erosion and sediment control/stormwater certification.
 - (c) Notify the Engineer when the required certified erosion and sediment control/stormwater personnel are not available on the job site when needed.
 - (d) Conduct the inspections required by the NPDES permit.
 - (e) Take corrective actions in the proper timeframe as required by the NPDES permit for problem areas identified during the NPDES inspections.
 - (f) Incorporate erosion control into the work in a timely manner and stabilize disturbed areas with mulch/seed or vegetative cover on a section-by-section basis.
 - (g) Use flocculants approved by state regulatory authorities where appropriate and where required for turbidity and sedimentation reduction.
 - (h) Ensure proper installation and maintenance of temporary erosion and sediment control devices.
 - (i) Remove temporary erosion or sediment control devices when they are no longer necessary as agreed upon by the Engineer.
 - (j) The Contractor's quality control and inspection procedures shall be subject to review by the Engineer. Maintain NPDES inspection records and make records available at all times for verification by the Engineer.
- (B) *Certified Foreman* - At least one Certified Foreman shall be onsite for each type of work listed herein during the respective construction activities to control erosion, prevent sedimentation and follow permit provisions:
- (1) Foreman in charge of grading activities
 - (2) Foreman in charge of bridge or culvert construction over jurisdictional areas
 - (3) Foreman in charge of utility activities
- The Contractor may request to use the same person as the Level II Supervisor and Level II Foreman. This person shall be onsite whenever construction activities as described above are taking place. This request shall be approved by the Engineer prior to work beginning.
- The Contractor may request to name a single Level II Foreman to oversee multiple construction activities on small bridge or culvert replacement projects. This request shall be approved by the Engineer prior to work beginning.
- (C) *Certified Installers* - Provide at least one onsite, Level I Certified Installer for each of the following erosion and sediment control/stormwater crew:
- (1) Seeding and Mulching
 - (2) Temporary Seeding

- (3) Temporary Mulching
- (4) Sodding
- (5) Silt fence or other perimeter erosion/sediment control device installations
- (6) Erosion control blanket installation
- (7) Hydraulic tackifier installation
- (8) Turbidity curtain installation
- (9) Rock ditch check/sediment dam installation
- (10) Ditch liner/matting installation
- (11) Inlet protection
- (12) Riprap placement
- (13) Stormwater BMP installations (such as but not limited to level spreaders, retention/detention devices)
- (14) Pipe installations within jurisdictional areas

If a Level I *Certified Installer* is not onsite, the Contractor may substitute a Level II Foreman for a Level I Installer, provided the Level II Foreman is not tasked to another crew requiring Level II Foreman oversight.

- (D) *Certified Designer* - Include the certification number of the Level III-B Certified Designer on the erosion and sediment control/stormwater component of all reclamation plans and if applicable, the certification number of the Level III-A Certified Designer on the design of the project erosion and sediment control/stormwater plan.

Preconstruction Meeting

Furnish the names of the *Certified Erosion and Sediment Control/Stormwater Supervisor*, *Certified Foremen*, *Certified Installers* and *Certified Designer* and notify the Engineer of changes in certified personnel over the life of the contract within 2 days of change.

Ethical Responsibility

Any company performing work for the North Carolina Department of Transportation has the ethical responsibility to fully disclose any reprimand or dismissal of an employee resulting from improper testing or falsification of records.

Revocation or Suspension of Certification

Upon recommendation of the Chief Engineer to the certification entity, certification for *Supervisor*, *Certified Foremen*, *Certified Installers* and *Certified Designer* may be revoked or suspended with the issuance of an *Immediate Corrective Action (ICA)*, *Notice of Violation (NOV)*, or *Cease and Desist Order* for erosion and sediment control/stormwater related issues.

The Chief Engineer may recommend suspension or permanent revocation of certification due to the following:

- (A) Failure to adequately perform the duties as defined within this certification provision.
- (B) Issuance of an ICA, NOV, or Cease and Desist Order.

- (C) Failure to fully perform environmental commitments as detailed within the permit conditions and specifications.
- (D) Demonstration of erroneous documentation or reporting techniques.
- (E) Cheating or copying another candidate's work on an examination.
- (F) Intentional falsification of records.
- (G) Directing a subordinate under direct or indirect supervision to perform any of the above actions.
- (H) Dismissal from a company for any of the above reasons.
- (I) Suspension or revocation of one's certification by another entity.

Suspension or revocation of a certification will be sent by certified mail to the certificant and the Corporate Head of the company that employs the certificant.

A certificant has the right to appeal any adverse action which results in suspension or permanent revocation of certification by responding, in writing, to the Chief Engineer within 10 calendar days after receiving notice of the proposed adverse action.

Chief Engineer
1536 Mail Service Center
Raleigh, NC 27699-1536

Failure to appeal within 10 calendar days will result in the proposed adverse action becoming effective on the date specified on the certified notice. Failure to appeal within the time specified will result in a waiver of all future appeal rights regarding the adverse action taken. The certificant will not be allowed to perform duties associated with the certification during the appeal process.

The Chief Engineer will hear the appeal and make a decision within 7 days of hearing the appeal. Decision of the Chief Engineer will be final and will be made in writing to the certificant.

If a certification is temporarily suspended, the certificant shall pass any applicable written examination and any proficiency examination, at the conclusion of the specified suspension period, prior to having the certification reinstated.

Measurement and Payment

Certified Erosion and Sediment Control/Stormwater Supervisor, Certified Foremen, Certified Installers and Certified Designer will be incidental to the project for which no direct compensation will be made.

PROCEDURE FOR MONITORING BORROW PIT DISCHARGE:

(2-20-07) (Rev. 4-5-19)

105-16, 230, 801

SP1 G181

Water discharge from borrow pit sites shall not cause surface waters to exceed 50 NTUs (nephelometric turbidity unit) in streams not designated as trout waters and 10 NTUs in streams, lakes or reservoirs designated as trout waters. For lakes and reservoirs not designated as trout waters, the turbidity shall not exceed 25 NTUs. If the turbidity exceeds these levels due to natural background conditions, the existing turbidity level shall not be increased.

If during any operating day, the downstream water quality exceeds the standard, the Contractor shall do all of the following:

- (A) Either cease discharge or modify the discharge volume or turbidity levels to bring the downstream turbidity levels into compliance, or
- (B) Evaluate the upstream conditions to determine if the exceedance of the standard is due to natural background conditions. If the background turbidity measurements exceed the standard, operation of the pit and discharge can continue as long as the stream turbidity levels are not increased due to the discharge.
- (C) Measure and record the turbidity test results (time, date and sampler) at all defined sampling locations 30 minutes after startup and at a minimum, one additional sampling of all sampling locations during that 24-hour period in which the borrow pit is discharging.
- (D) Notify DWQ within 24 hours of any stream turbidity standard exceedances that are not brought into compliance.

During the Environmental Assessment required by Article 230-4 of the *2018 Standard Specifications*, the Contractor shall define the point at which the discharge enters into the State's surface waters and the appropriate sampling locations. Sampling locations shall include points upstream and downstream from the point at which the discharge enters these waters. Upstream sampling location shall be located so that it is not influenced by backwater conditions and represents natural background conditions. Downstream sampling location shall be located at the point where complete mixing of the discharge and receiving water has occurred.

The discharge shall be closely monitored when water from the dewatering activities is introduced into jurisdictional wetlands. Any time visible sedimentation (deposition of sediment) on the wetland surface is observed, the dewatering activity will be suspended until turbidity levels in the stilling basin can be reduced to a level where sediment deposition does not occur. Staining of wetland surfaces from suspended clay particles, occurring after evaporation or infiltration, does not constitute sedimentation. No activities shall occur in wetlands that adversely affect the functioning of a wetland. Visible sedimentation will be considered an indication of possible adverse impacts on wetland use.

The Engineer will perform independent turbidity tests on a random basis. These results will be maintained in a log within the project records. Records will include, at a minimum, turbidity test results, time, date and name of sampler. Should the Department's test results exceed those of the Contractor's test results, an immediate test shall be performed jointly with the results superseding the previous test results of both the Department and the Contractor.

The Contractor shall use the *NCDOT Turbidity Reduction Options for Borrow Pits Matrix*, available at <https://connect.ncdot.gov/resources/roadside/FieldOperationsDocuments/TurbidityReductionOptionSheet.pdf> to plan, design, construct, and maintain BMPs to address water quality standards. Tier I Methods include stilling basins which are standard compensatory BMPs. Other Tier I methods are noncompensatory and shall be used when needed to meet the stream turbidity standards. Tier II Methods are also noncompensatory and are options that may be needed for protection of rare or unique resources or where special environmental conditions

exist at the site which have led to additional requirements being placed in the DWQ's 401 Certifications and approval letters, Isolated Wetland Permits, Riparian Buffer Authorization or a DOT Reclamation Plan's Environmental Assessment for the specific site. Should the Contractor exhaust all Tier I Methods on a site exclusive of rare or unique resources or special environmental conditions, Tier II Methods may be required by regulators on a case by case basis per supplemental agreement.

The Contractor may use cation exchange capacity (CEC) values from proposed site borings to plan and develop the bid for the project. CEC values exceeding 15 milliequivalents per 100 grams of soil may indicate a high potential for turbidity and should be avoided when dewatering into surface water is proposed.

No additional compensation for monitoring borrow pit discharge will be paid.

PROJECT SPECIAL PROVISIONS**ROADWAY****CLEARING AND GRUBBING - METHOD III:**

(4-6-06) (Rev.8-18-15)

200

SP2 R02B

Perform clearing on this project to the limits established by Method “III” shown on Standard Drawing No. 200.03 of the *2018 Roadway Standard Drawings*. Conventional clearing methods may be used except where permit drawings or conditions have been included in the proposal which require certain areas to be cleared by hand methods.

SHOULDER AND FILL SLOPE MATERIAL:

(5-21-02)

235, 560

SP2 R45 B

Description

Perform the required shoulder and slope construction for this project in accordance with the applicable requirements of Section 560 and Section 235 of the *2018 Standard Specifications*.

Measurement and Payment

When the Contractor elects to obtain material from an area located beneath a proposed fill sections which does not require excavation for any reason other than to generate acceptable shoulder and fill slope material, the work of performing the excavation will be considered incidental to the item of *Borrow Excavation* or *Shoulder Borrow*. If there is no pay item for *Borrow* or *Shoulder Borrow* in the contract, this work will be considered incidental to *Unclassified Excavation*. Stockpile the excavated material in a manner to facilitate measurement by the Engineer. Fill the void created by the excavation of the shoulder and fill slope material with suitable material. Payment for material used from the stockpile will be made at the contract unit price for *Borrow Excavation* or *Shoulder Borrow*. If there is no pay item for *Borrow Excavation* or *Shoulder Borrow*, then the material will be paid for at the contract unit price for *Unclassified Excavation*. The material used to fill the void created by the excavation of the shoulder and fill slope material will be made at the contract unit price for *Unclassified Excavation*, *Borrow Excavation*, or *Shoulder Borrow*, depending on the source of the material.

Material generated from undercut excavation, unclassified excavation or clearing and grubbing operations that is placed directly on shoulders or slope areas, will not be measured separately for payment, as payment for the work requiring the excavation will be considered adequate compensation for depositing and grading the material on the shoulders or slopes.

When undercut excavation is performed at the direction of the Engineer and the material excavated is found to be suitable for use as shoulder and fill slope material, and there is no area on the project currently prepared to receive the material generated by the undercut operation, the Contractor may construct a stockpile for use as borrow at a later date. Payment for the material used from the stockpile will be made at the contract unit price for *Borrow Excavation* or *Shoulder Borrow*.

When shoulder material is obtained from borrow sources or from stockpiled material, payment for the work of shoulder construction will be made at the contract unit price per cubic yard for *Borrow*

Excavation or Shoulder Borrow in accordance with the applicable provisions of Section 230 or Section 560 of the *2018 Standard Specifications*.

MANUFACTURED QUARRY FINES IN EMBANKMENTS:

(01-17-17)

235

SP02 R72

Description

This specification addresses the use of manufactured quarry fines that are not classified as select materials. The specification allows the Contractor an option, with the approval of the Engineer, to use manufactured quarry fines (MQFs) in embankments as a substitute for conventional borrow material. Furnish and place geotextile for pavement stabilization in accordance with the Geotextile for Pavement Stabilization special provision and detail. Geotextile for pavement stabilization is required to prevent pavement cracking and provide separation between the subgrade and pavement section at embankment locations where manufactured quarry fines are utilized and as directed by the Engineer.

Materials

Manufactured Quarry Fines.

Site specific approval of MQFs material will be required prior to beginning construction as detailed in the preconstruction requirements of this provision.

The following MQFs are unacceptable:

- (A) Frozen material,
- (B) Material with a maximum dry unit weight of less than 90 pounds per cubic foot when tested in accordance with AASHTO T-99 Method A or C.
- (C) Material with greater than 80% by weight Passing the #200 sieve

Collect and transport MQFs in a manner that will prevent nuisances and hazards to public health and safety. Moisture condition the MQFs as needed and transport in covered trucks to prevent dusting. If MQFs are blended with natural earth material, follow Borrow Criteria in Section 1018 of the *Standard Specifications*.

Geotextiles

Areas of embankment where MQFs are incorporated, Geotextile for Pavement Stabilization shall be used. If the Geotextile for Pavement Stabilization special provision is not included elsewhere in this contract, then it along with a detail will be incorporated as part of the contractors request to use. Notification of subgrade elevation, sampling and waiting period as required in the Construction Methods section of the Geotextile for Pavement Stabilization special provision are not required.

Preconstruction Requirements

When MQFs are to be used as a substitute for earth borrow material, request written approval from the Engineer at least ninety (90) days in advance of the intent to use MQFs and include the following details:

- (A) Description, purpose and location of project.
- (B) Estimated start and completion dates of project.
- (C) Estimated volume of MQFs to be used on project with specific locations and construction details of the placement.
- (D) The names, address, and contact information for the generator of the MQFs.
- (E) Physical location of the site at which the MQFs were generated.

The Engineer will forward this information to the State Materials Engineer for review and material approval.

Construction Methods

Place MQFs in the core of the embankment section with at least 4 feet of earth cover to the outside limits of the embankments or subgrade.

Construct embankments by placing MQFs in level uniform lifts with no more than a lift of 10 inches and compacted to at least a density of 95 percent as determined by test methods in AASHTO T-99, Determination of Maximum Dry Density and Optimum Moisture Content, Method A or C depending upon particle size of the product. Provide a moisture content at the time of compaction of within 4 percent of optimum but not greater than one percent above optimum as determined by AASHTO T-99, Method A or C.

Areas of embankment where MQFs are incorporated, Geotextile for Pavement Stabilization shall be used. See Geotextile for Pavement Stabilization special provision for geotextile type and construction method.

Measurement and Payment

Borrow Excavation will be measured by truck volume and paid in cubic yards in accordance with Article 230-5 of the *2018 Standard Specifications*. As an alternate weigh tickets can be provided and payment made by converting weight to cubic yards based on the verifiable unit weight.

Where the pay item of *Geotextile for Pavement Stabilization* is included in the original contract the material will be measured and paid in square yards (see Geotextile for Pavement Stabilization special provision). Where the pay item of *Geotextile for Pavement Stabilization* is not included in the original contract then no payment will be made for this item and will be considered incidental to the use of MQFs in embankment.

REMOVE WOOD POLE:

Description

Remove existing wood poles, guy wires and conduit, as shown on the plans or as directed by the Engineer, that are in conflict with the construction of the project. All electrical and communication utilities will be removed by others prior to removal of poles.

Measurement and Payment

Remove wood pole will be measured and paid as the actual number of wood poles, including any guy wires and conduit connected to poles, that are removed. If the Department chooses to retain removed poles, the Contractor shall stockpile selected poles, notify the Engineer that poles are available for pickup, and load selected poles. Poles that the Department does not take possession of become the responsibility of the Contractor to transport and properly dispose of wood poles, guy wires and conduit. Such price and payment shall be full compensation to the Contractor for all labor and equipment necessary for the removal, stockpiling and disposal of wood poles.

Payment will be made under:

Pay Item
Remove Wood Pole

Pay Unit
Each

FLOWABLE FILL:

(9-17-02) (Rev 1-17-12)

300, 340, 1000, 1530, 1540, 1550

SP3 R30

Description

This work consists of all work necessary to place flowable fill in accordance with these provisions, the plans, and as directed.

Materials

Refer to Division 10 of the *2018 Standard Specifications*.

Item
Flowable Fill

Section
1000-6

Construction Methods

Discharge flowable fill material directly from the truck into the space to be filled, or by other approved methods. The mix may be placed full depth or in lifts as site conditions dictate. The Contractor shall provide a method to plug the ends of the existing pipe in order to contain the flowable fill.

Measurement and Payment

At locations where flowable fill is called for on the plans and a pay item for flowable fill is included in the contract, *Flowable Fill* will be measured in cubic yards and paid as the actual number of cubic yards that have been satisfactorily placed and accepted. Such price and payment will be full compensation for all work covered by this provision including, but not limited to, the mix design, furnishing, hauling, placing and containing the flowable fill.

Payment will be made under:

Pay Item
Flowable Fill

Pay Unit
Cubic Yard

POLYPROPYLENE CULVERT PIPE:

(8-20-19)

305,310

SP3 R35

Revise the *2018 Standard Specifications* as follows:

Page 3-5, Article 305-1 DESCRIPTION, lines 12-14, replace with the following:

Where shown in the plans, the Contractor may use reinforced concrete pipe, aluminum alloy pipe, aluminized corrugated steel pipe, HDPE pipe, Polypropylene Pipe, or PVC pipe in accordance with the following requirements.

Page 3-5, Article 305-2 MATERIALS, add the following after line 16:

Item	Section
Polypropylene Pipe	1032-9

Page 3-6, Article 310-2 MATERIALS, add the following after line 9:

Item	Section
Polypropylene Pipe	1032-9

Page 3-6, Article 310-4 SIDE DRAIN PIPE, lines 24-25, replace the first sentence of the second paragraph with the following:

Where shown in the plans, side drain pipe may be Class II reinforced concrete pipe, aluminized corrugated steel pipe, corrugated aluminum alloy pipe, polypropylene pipe, HDPE pipe or PVC pipe.

Page 3-7, Article 310-5 PIPE END SECTIONS, lines 2-4, replace the second sentence with the following:

Both corrugated steel and concrete pipe end sections will work on concrete pipe, corrugated steel pipe, polypropylene pipe, and HDPE smooth lined corrugated plastic pipe.

Page 3-7, Article 310-6 MEASUREMENT AND PAYMENT, add the following after line 14:

Pay Item	Pay Unit
___" Polypropylene Pipe	Linear Foot

Page 10-60, add Article 1032-9:

(A) General

Use polypropylene pipe from sources participating in the Department's Polypropylene Pipe QA/QC Program. A list of participating sources is available from the Materials and Tests Unit. The Department will remove a manufacturer of polypropylene pipe from this program if the monitoring efforts indicated that non-specification material is being provided or test procedures are not being followed.

Use polypropylene culvert pipe that meets AASHTO M 330 for Type S or Type D, or ASTM F2881 or ASTM F2764 Double or Triple wall; and has been evaluated by NTPEP.

(B) End Treatments, Pipe Tees and Elbows

End treatments, pipe tees and elbows shall meet AASHTO M 330, Section 7.7, or ASTM F2764, Section 6.6.

(C) Marking

Clearly mark each section of pipe, end section, tee and elbow and other accessories according to the Department's Polypropylene Pipe QC/QA Program:

- (1) AASHTO or ASTM Designation
- (2) The date of manufacture
- (3) Name or trademark of the manufacturer

When polypropylene pipe, end sections, tees and elbows have been inspected and accepted a sticker will be applied to the inside of the pipe. Do not use pipe sections, flared end sections, tees or elbows which do not have this seal of approval.

AGGREGATE SUBGRADE:

(5-15-18)

505

SP5 R8

Revise the *2018 Standard Specifications* as follows:

Page 5-8, Article 505-1 DESCRIPTION, lines 4-6, replace the paragraph with the following:

Construct aggregate subgrades in accordance with the contract. Install geotextile for soil stabilization and place Class IV subgrade stabilization at locations shown in the plans and as directed.

Undercut natural soil materials if necessary to construct aggregate subgrades. Define "subbase" as the portion of the roadbed below the Class IV subgrade stabilization. For Type 2 aggregate subgrades, undercut subbases as needed. The types of aggregate subgrade with thickness and compaction requirements for each are as shown below.

Type 1 – A 6 to 24 inch thick aggregate subgrade with Class IV subgrade stabilization compacted to 92% of AASHTO T 180 as modified by the Department or to the highest density that can be reasonably obtained.

Type 2 – An 8 inch thick aggregate subgrade on a proof rolled subbase with Class IV subgrade stabilization compacted to 97% of AASHTO T 180 as modified by the Department.

Page 5-8, Article 505-3 CONSTRUCTION METHODS, line 12, insert the following after the first sentence of the first paragraph:

For Type 2 aggregate subgrades, proof roll subbases in accordance with Section 260 before installing geotextile for soil stabilization.

Page 5-8, Article 505-3 CONSTRUCTION METHODS, lines 16-17, replace the last sentence of the first paragraph with the following:

Compact ABC as required for the type of aggregate subgrade constructed.

Page 5-8, Article 505-4 MEASUREMENT AND PAYMENT, line 26, insert the following after the last sentence of the first paragraph:

Undercut Excavation of natural soil materials from subbases for Type 2 aggregate subgrades will be measured and paid in accordance with Article 225-7 or 226-3. No measurement will be made for any undercut excavation of fill materials from subbases.

PRICE ADJUSTMENT - ASPHALT BINDER FOR PLANT MIX:

(11-21-00)

620

SP6 R25

Price adjustments for asphalt binder for plant mix will be made in accordance with Section 620 of the *2018 Standard Specifications*.

The base price index for asphalt binder for plant mix is **\$ 494.58** per ton.

This base price index represents an average of F.O.B. selling prices of asphalt binder at supplier's terminals on **February 1, 2020**.

FINAL SURFACE TESTING NOT REQUIRED:

(5-18-04) (Rev. 2-16-16)

610

SP6 R45

Final surface testing is not required on this project in accordance with Section 610-13, *Final Surface Testing and Acceptance*.

MILLING ASPHALT PAVEMENT:

(1-15-19)

607

SP6 R59

Revise the *2018 Standard Specifications* as follows:

Page 6-5, Article 607-2, EQUIPMENT, lines 14-16, delete the seventh sentence of this Article and replace with the following:

Use either a non-contacting laser or sonar type ski system with a minimum of three referencing stations mounted on the milling machine at a length of at least 24 feet.

ASPHALT CONCRETE PLANT MIX PAVEMENTS:

(2-20-18) (Rev.1-15-19)

610, 1012

SP6 R65

Revise the *2018 Standard Specifications* as follows:

Page 6-14, Table 609-3, LIMITS OF PRECISION FOR TEST RESULTS, replace with the following:

Mix Property	Limits of Precision
25.0 mm sieve (Base Mix)	± 10.0%
19.0 mm sieve (Base Mix)	± 10.0%
12.5 mm sieve (Intermediate & Type P-57)	± 6.0%
9.5 mm sieve (Surface Mix)	± 5.0%
4.75 mm sieve (Surface Mix)	± 5.0%
2.36 mm sieve (All Mixes, except S4.75A)	± 5.0%
1.18 mm sieve (S4.75A)	± 5.0%

0.075 mm sieve (All Mixes)	± 2.0%
Asphalt Binder Content	± 0.5%
Maximum Specific Gravity (G_{mm})	± 0.020
Bulk Specific Gravity (G_{mb})	± 0.030
TSR	± 15.0%
QA retest of prepared QC Gyratory Compacted Volumetric Specimens	± 0.015
Retest of QC Core Sample	± 1.2% (% Compaction)
Comparison QA Core Sample	± 2.0% (% Compaction)
QA Verification Core Sample	± 2.0% (% Compaction)
Density Gauge Comparison of QC Test	± 2.0% (% Compaction)
QA Density Gauge Verification Test	± 2.0% (% Compaction)

Page 6-17, Table 610-1, MIXING TEMPERATURE AT THE ASPHALT PLANT, replace with the following:

Binder Grade	JMF Temperature
PG 58-28; PG 64-22	250 - 290°F
PG 76-22	300 - 325°F

Page 6-17, Subarticle 610-3(C), Job Mix Formula (JMF), lines 38-39, delete the fourth paragraph.

Page 6-18, Subarticle 610-3(C), Job Mix Formula (JMF), line 12, replace “SF9.5A” with “S9.5B”.

Page 6-18, Table 610-3, MIX DESIGN CRITERIA, replace with the following:

Mix Type	Design ESALs millions ^A	Binder PG Grade	Compaction Levels		Max. Rut Depth (mm)	Volumetric Properties ^B			
			G_{mm} @			VMA % Min.	VTM %	VFA Min.-Max.	% G_{mm} @ N_{ini}
			N_{ini}	N_{des}					
S4.75A	< 1	64 - 22	6	50	11.5	16.0	4.0 - 6.0	65 - 80	≤ 91.5
S9.5B	0 - 3	64 - 22	6	50	9.5	16.0	3.0 - 5.0	70 - 80	≤ 91.5
S9.5C	3 - 30	64 - 22	7	65	6.5	15.5	3.0 - 5.0	65 - 78	≤ 90.5
S9.5D	> 30	76 - 22	8	100	4.5	15.5	3.0 - 5.0	65 - 78	≤ 90.0
I19.0C	ALL	64 - 22	7	65	-	13.5	3.0 - 5.0	65 - 78	≤ 90.5
B25.0C	ALL	64 - 22	7	65	-	12.5	3.0 - 5.0	65 - 78	≤ 90.5
Design Parameter					Design Criteria				
All Mix Types	Dust to Binder Ratio ($P_{0.075} / P_{be}$)				0.6 - 1.4 ^C				
	Tensile Strength Ratio (TSR) ^D				85% Min. ^E				

A. Based on 20 year design traffic.

B. Volumetric Properties based on specimens compacted to N_{des} as modified by the Department.

C. Dust to Binder Ratio ($P_{0.075} / P_{be}$) for Type S4.75A is 1.0 - 2.0.

D. NCDOT-T-283 (No Freeze-Thaw cycle required).

E. TSR for Type S4.75A & B25.0C mixes is 80% minimum.

Page 6-19, Table 610-5, BINDER GRADE REQUIREMENTS (BASED ON RBR%), replace with the following:

**TABLE 610-5
BINDER GRADE REQUIREMENTS (BASED ON RBR%)**

Mix Type	%RBR \leq 20%	21% \leq %RBR \leq 30%	%RBR \geq 30%
S4.75A, S9.5B, S9.5C, I19.0C, B25.0C	PG 64-22	PG 64-22 ^A	PG-58-28
S9.5D, OGFC	PG 76-22 ^B	n/a	n/a

A. If the mix contains any amount of RAS, the virgin binder shall be PG 58-28.

B. Maximum Recycled Binder Replacement (%RBR) is 18% for mixes using PG 76-22 binder.

Page 6-20, Table 610-6, PLACEMENT TEMPERATURES FOR ASPHALT, replace with the following:

**TABLE 610-6
PLACEMENT TEMPERATURES FOR ASPHALT**

Asphalt Concrete Mix Type	Minimum Surface and Air Temperature
B25.0C	35°F
I19.0C	35°F
S4.75A, S9.5B, S9.5C	40°F ^A
S9.5D	50°F

A. For the final layer of surface mixes containing recycled asphalt shingles (RAS), the minimum surface and air temperature shall be 50°F.

Page 6-21, Article 610-8, SPREADING AND FINISHING, lines 34-35, delete the second sentence and replace with the following:

Use an MTV for all surface mix regardless of binder grade on Interstate, US Routes, and NC Routes (primary routes) that have 4 or more lanes and median divided.

Page 6-21, Article 610-8, SPREADING AND FINISHING, lines 36-38, delete the fourth sentence and replace with the following:

Use MTV for all ramps, loops, Y-line that have 4 or more lanes and are median divided, full width acceleration lanes, full width deceleration lanes, and full width turn lanes that are greater than 1000 feet in length.

Page 6-23, Table 610-7, DENSITY REQUIREMENTS, replace with the following:

**TABLE 610-7
DENSITY REQUIREMENTS**

Mix Type	Minimum % G _{mm} (Maximum Specific Gravity)
S4.75A	85.0 ^A
S9.5B	90.0
S9.5C, S9.5D, I19.0C, B25.0C	92.0

A. Compaction to the above specified density will be required when the S4.75A mix is applied at a rate of 100 lbs/sy or higher.

Page 6-24, Article 610-13, FINAL SURFACE TESTING, lines 35-36, delete the second sentence and replace with the following:

Final surface testing is not required on ramps, loops and turn lanes.

Page 6-26, Subarticle 610-13(A)(1), Acceptance for New Construction, lines 29-30, delete the second sentence and replace with the following:

Areas excluded from testing by the profiler may be tested using a 10-foot straightedge in accordance with Article 610-12.

Page 6-27, Subarticle 610-13(B), Option 2- North Carolina Hearne Straightedge, lines 41-46, delete the eighth and ninth sentence of this paragraph and replace with the following:

Take profiles over the entire length of the final surface travel lane pavement exclusive of structures, approach slabs, paved shoulders, tapers, or other irregular shaped areas of pavement, unless otherwise approved by the Engineer. Test in accordance with this provision all mainline travel lanes, full width acceleration or deceleration lanes and collector lanes.

Page 6-28, Subarticle 610-13(B), Option 2- North Carolina Hearne Straightedge, lines 1-2, delete these two lines.

Page 6-32, Article 610-16 MEASUREMENT AND PAYMENT, replace with the following:

Pay Item	Pay Unit
Asphalt Concrete Base Course, Type B25.0C	Ton
Asphalt Concrete Intermediate Course, Type I19.0C	Ton
Asphalt Concrete Surface Course, Type S4.75A	Ton
Asphalt Concrete Surface Course, Type S9.5B	Ton
Asphalt Concrete Surface Course, Type S9.5C	Ton
Asphalt Concrete Surface Course, Type S9.5D	Ton

Page 10-30, Table 1012-1, AGGREGATE CONSENSUS PROPERTIES, replace with the following:

**TABLE 1012-1
AGGREGATE CONSENSUS PROPERTIES^A**

Mix Type	Coarse Aggregate Angularity^B	Fine Aggregate Angularity % Minimum	Sand Equivalent % Minimum	Flat and Elongated 5 : 1 Ratio % Maximum
<i>Test Method</i>	<i>ASTM D5821</i>	<i>AASHTO T 304</i>	<i>AASHTO T 176</i>	<i>ASTM D4791</i>
S4.75A; S9.5B	75 / -	40	40	-
S9.5C; I19.0C; B25.0C	95 / 90	45	45	10
S9.5D	100 / 100	45	50	10

OGFC	100 / 100	45	45	10
UBWC	100 / 85	45	45	10

A. Requirements apply to the design aggregate blend.

B. 95 / 90 denotes that 95% of the coarse aggregate has one fractured face and 90% has 2 or more fractured faces.

PATCHING EXISTING PAVEMENT:

(1-15-02) (Rev. 3-11-18)

610

SP6 R88R

Description

The Contractor's attention is directed to the fact that there are areas of existing pavement on this project that will require repair prior to resurfacing. Patch the areas that, in the opinion of the Engineer, need repairing. The areas to be patched will be delineated by the Engineer prior to the Contractor performing repairs.

Materials

The patching consists of Asphalt Concrete Base Course, Asphalt Concrete Intermediate Course, Asphalt Concrete Surface Course, or a combination of base, binder and surface course.

Construction Methods

Remove existing pavement at locations directed by the Engineer in accordance with Section 250 of the *2018 Standard Specifications*.

Place Asphalt Concrete Base Course, in lifts not exceeding 5.5 inches. Utilize compaction equipment suitable for compacting patches as small as 3.5 feet by 6 feet on each lift. Use an approved compaction pattern to achieve proper compaction. If patched pavement is to be open to traffic for more than 48 hours prior to overlay, use Asphalt Surface Course in the top 1.5 inches of the patch.

Schedule operations so that all areas where pavement has been removed will be repaired on the same day of the pavement removal and all lanes of traffic restored.

Measurement and Payment

Patching Existing Pavement will be measured and paid as the actual number of tons of asphalt plant mix complete in place that has been used to make completed and accepted repairs. The asphalt plant mixed material will be measured by being weighed in trucks on certified platform scales or other certified weighing devices. The above price and payment will be full compensation for all work covered by this provision, including but not limited to removal and disposal of all types of pavement; furnishing and applying tack coat; furnishing, placing, and compacting of asphalt plant mix; furnishing of asphalt binder for the asphalt plant mix; and furnishing scales.

Any provisions included in the contract that provides for adjustments in compensation due to variations in the price of asphalt binder will not be applicable to payment for the work covered by this provision.

Payment will be made under:

Pay Item

Patching Existing Pavement

Pay Unit

Ton

AUTOMATED MACHINE GUIDANCE

(1-2-11)

801

SP8 R01

General

This Special Provision contains requirements to be followed if the Contractor elects to use Global Positioning System (GPS) machine control grading and shall be used in conjunction with Section 801 of the *Standard Specifications*. The use of this technology is referenced as Automated Machine Guidance (AMG).

All equipment using AMG shall be able to generate end results that meet the *Standard Specifications*. Perform test sections for each type of work to be completed with AMG to demonstrate that the system has the capability to achieve acceptable results. If acceptable results cannot be achieved, conform to the requirements for conventional stakeout.

The Contractor shall be responsible for all errors resulting from the use of AMG and shall correct deficiencies to the satisfaction of the Engineer at no cost to the Department.

Submittals

If the Contractor elects to use AMG, a Digital Terrain Model (DTM) of the design surface and all intermediate surfaces shall be developed and submitted to the Engineer for review.

At least 90 days prior to beginning grading operations, the Contractor shall submit to the Engineer an AMG work plan to include, but not limited to, proposed equipment, control software manufacturer and version, types of work to be completed using AMG, project site calibration report, repetitive calibration methods for construction equipment and rover units to be used for the duration of the project, and local GPS base station to be used for broadcasting differential correction data to rover units (this may include the NC Network RTK). All surveys must be tied to existing project control as established by NCDOT.

Inspection

The Engineer will perform quality assurance checks of all work associated with AMG. If it is determined that work is not being performed in a manner that will assure accurate results, the Engineer may require corrective action at no cost to the Department.

The Contractor shall provide the Engineer with one GPS rover unit for use during the duration of the contract. The rover will be loaded with the same model that is used with the AMG and have the same capability as rover units used by the Contractor. The rover will be kept in the possession of the Engineer and will be returned to the Contractor upon completion of the contract. Any maintenance or repairs required for the rover will be the responsibility of the Contractor. Formal training of at least 8 hours shall be provided to the Engineer by the Contractor on the use of the proposed AMG system.

Subgrade and Base Controls

If the Contractor elects to use AMG for fine grading and placement of base or other roadway materials, the GPS shall be supplemented with a laser or robotic total station. Include details of the proposed system in the AMG work plan. In addition, the following requirements apply for the use of AMG for subgrade and base construction.

Provide control points at intervals along the project not to exceed 1,000 feet. The horizontal position of these points shall be determined by static GPS sessions or by traverse connection from the original base line control points. The elevation of these control points shall be established using differential leveling from project benchmarks, forming closed loops where practical. A copy of all new control point information shall be provided to the Engineer prior to construction activities.

Provide control points and conventional survey grade stakes at 500 foot intervals and at critical points such as, but not limited to, PCs, PTs, superelevation transition points, and other critical points as requested by the Engineer.

Provide hubs at the top of the finished subgrade at all hinge points on the cross section at 500 foot intervals. These hubs shall be established using conventional survey methods for use by the Engineer to check the accuracy of construction.

Measurement and Payment

No direct payment will be made for work required to utilize this provision. All work will be considered incidental to various grading operations.

GUARDRAIL END UNITS, TYPE - TL-3:

(4-20-04) (Rev. 7-1-17)

862

SP8 R65

Description

Furnish and install guardrail end units in accordance with the details in the plans, the applicable requirements of Section 862 of the *2018 Standard Specifications*, and at locations shown in the plans.

Materials

Furnish guardrail end units listed on the NCDOT [Approved Products List](https://apps.dot.state.nc.us/vendor/approvedproducts/) at <https://apps.dot.state.nc.us/vendor/approvedproducts/> or approved equal.

Prior to installation the Contractor shall submit to the Engineer:

- (A) FHWA acceptance letter for each guardrail end unit certifying it meets the requirements of the AASHTO Manual for Assessing Safety Hardware, Test Level 3, in accordance with Article 106-2 of the *2018 Standard Specifications*.
- (B) Certified working drawings and assembling instructions from the manufacturer for each guardrail end unit in accordance with Article 105-2 of the *2018 Standard Specifications*.

No modifications shall be made to the guardrail end unit without the express written permission from the manufacturer. Perform installation in accordance with the details in the plans, and details and assembling instructions furnished by the manufacturer.

Construction Methods

Guardrail end delineation is required on all approach and trailing end sections for both temporary and permanent installations. Guardrail end delineation consists of yellow reflective sheeting applied to the entire end section of the guardrail in accordance with Article 1088-3 of the *2018 Standard Specifications* and is incidental to the cost of the guardrail end unit.

Measurement and Payment

Measurement and payment will be made in accordance with Article 862-6 of the *2018 Standard Specifications*.

Payment will be made under:

Pay Item

Guardrail End Units, Type TL-3

Pay Unit

Each

FOUNDATIONS AND ANCHOR ROD ASSEMBLIES FOR METAL POLES:

(1-17-12) (Rev. 1-16-18)

9, 14, 17

SP9 R05

Description

Foundations for metal poles include foundations for signals, cameras, overhead and dynamic message signs (DMS) and high mount and light standards supported by metal poles or upright trusses. Foundations consist of footings with pedestals and drilled piers with or without grade beams or wings. Anchor rod assemblies consist of anchor rods (also called anchor bolts) with nuts and washers on the exposed ends of rods and nuts and a plate or washers on the other ends of rods embedded in the foundation.

Construct concrete foundations with the required resistances and dimensions and install anchor rod assemblies in accordance with the contract and accepted submittals. Construct drilled piers consisting of cast-in-place reinforced concrete cylindrical sections in excavated holes. Provide temporary casings or polymer slurry as needed to stabilize drilled pier excavations. Use a prequalified Drilled Pier Contractor to construct drilled piers for metal poles. Define "excavation" and "hole" as a drilled pier excavation and "pier" as a drilled pier.

This provision does not apply to foundations for signal pedestals; see Section 1743 of the *2018 Standard Specifications* and 2018 Roadway Standard Drawing No. 1743.01.

Materials

Refer to the *2018 Standard Specifications*.

Item

Conduit

Section

1091-3

Item	Section
Grout, Type 2	1003
Polymer Slurry	411-2(B)(2)
Portland Cement Concrete	1000
Reinforcing Steel	1070
Rollers and Chairs	411-2(C)
Temporary Casings	411-2(A)

Provide Type 3 material certifications in accordance with Article 106-3 of the *2018 Standard Specifications* for conduit, rollers, chairs and anchor rod assemblies. Store steel materials on blocking at least 12" above the ground and protect it at all times from damage; and when placing in the work make sure it is free from dirt, dust, loose mill scale, loose rust, paint, oil or other foreign materials. Load, transport, unload and store foundation and anchor rod assembly materials so materials are kept clean and free of damage. Bent, damaged or defective materials will be rejected.

Use conduit type in accordance with the contract. Use Class A concrete for footings and pedestals, Class Drilled Pier concrete for drilled piers and Class AA concrete for grade beams and wings including portions of drilled piers above bottom of wings elevations. Corrugated temporary casings may be accepted at the discretion of the Engineer. A list of approved polymer slurry products is available from:

connect.ncdot.gov/resources/Geological/Pages/Products.aspx

Provide anchor rod assemblies in accordance with the contract consisting of the following:

- (A) Straight anchor rods,
- (B) Heavy hex top and leveling nuts and flat washers on exposed ends of rods, and
- (C) Nuts and either flat plates or washers on the other ends of anchor rods embedded in foundations.

Do not use lock washers. Use steel anchor rods, nuts and washers that meet ASTM F1554 for Grade 55 rods and Grade A nuts. Use steel plates and washers embedded in concrete with a thickness of at least 1/4". Galvanize anchor rods and exposed nuts and washers in accordance with Article 1076-4 of the *2018 Standard Specifications*. It is not necessary to galvanize nuts, plates and washers embedded in concrete.

Construction Methods

Install the required size and number of conduits in foundations in accordance with the plans and accepted submittals. Construct top of piers, footings, pedestals, grade beams and wings flat, level and within 1" of elevations shown in the plans or approved by the Engineer. Provide an Ordinary Surface finish in accordance with Subarticle 825-6(B) of the *2018 Standard Specifications* for portions of foundations exposed above finished grade. Do not remove anchor bolt templates or pedestal or grade beam forms or erect metal poles or upright trusses onto foundations until concrete attains a compressive strength of at least 3,000 psi.

(A) Drilled Piers

Before starting drilled pier construction, hold a predrill meeting to discuss the installation, monitoring and inspection of the drilled piers. Schedule this meeting after the Drilled Pier Contractor has mobilized to the site. The Resident or Division Traffic Engineer, Contractor and Drilled Pier Contractor Superintendent will attend this predrill meeting.

Do not excavate holes, install piles or allow equipment wheel loads or vibrations within 20 ft of completed piers until 16 hours after Drilled Pier concrete reaches initial set.

Check for correct drilled pier alignment and location before beginning drilling. Check plumbness of holes frequently during drilling.

Construct drilled piers with the minimum required diameters shown in the plans. Install piers with tip elevations no higher than shown in the plans or approved by the Engineer.

Excavate holes with equipment of the sizes required to construct drilled piers. Depending on the subsurface conditions encountered, drilling through rock and boulders may be required. Do not use blasting for drilled pier excavations.

Contain and dispose of drilling spoils and waste concrete as directed and in accordance with Section 802 of the *2018 Standard Specifications*. Drilling spoils consist of all materials and fluids removed from excavations.

If unstable, caving or sloughing materials are anticipated or encountered, stabilize holes with temporary casings and/or polymer slurry. Do not use telescoping temporary casings. If it becomes necessary to replace a temporary casing during drilling, backfill the excavation, insert a larger casing around the casing to be replaced or stabilize the excavation with polymer slurry before removing the temporary casing.

If temporary casings become stuck or the Contractor proposes leaving casings in place, temporary casings should be installed against undisturbed material. Unless otherwise approved, do not leave temporary casings in place for mast arm poles and cantilever signs. The Engineer will determine if casings may remain in place. If the Contractor proposes leaving temporary casings in place, do not begin drilling until a casing installation method is approved.

Use polymer slurry and additives to stabilize holes in accordance with the slurry manufacturer's recommendations. Provide mixing water and equipment suitable for polymer slurry. Maintain the required slurry properties at all times except for sand content.

Define a "sample set" as slurry samples collected from mid-height and within 2 ft of the bottom of holes. Take sample sets from excavations to test polymer slurry immediately after filling holes with slurry, at least every 4 hours thereafter and immediately before placing concrete. Do not place Drilled Pier concrete until both slurry samples from an excavation meet the required polymer slurry properties. If any slurry test results do not meet the requirements, the Engineer may suspend drilling until both samples from a sample set meet the required polymer slurry properties.

Remove soft and loose material from bottom of holes using augers to the satisfaction of the Engineer. Assemble rebar cages and place cages and Drilled Pier concrete in accordance with Subarticle 411-4(E) of the *2018 Standard Specifications* except for the following:

- (1) Inspections for tip resistance and bottom cleanliness are not required,
- (2) Temporary casings may remain in place if approved, and
- (3) Concrete placement may be paused near the top of pier elevations for anchor rod assembly installation and conduit placement or
- (4) If applicable, concrete placement may be stopped at bottom of grade beam or wings elevations for grade beam or wing construction.

If wet placement of concrete is anticipated or encountered, do not place Drilled Pier concrete until a concrete placement procedure is approved. If applicable, temporary casings and fluids may be removed when concrete placement is paused or stopped in accordance with the exceptions above provided holes are stable. Remove contaminated concrete from exposed Drilled Pier concrete after removing casings and fluids. If holes are unstable, do not remove temporary casings until a procedure for placing anchor rod assemblies and conduit or constructing grade beams or wings is approved.

Use collars to extend drilled piers above finished grade. Remove collars after Drilled Pier concrete sets and round top edges of piers.

If drilled piers are questionable, pile integrity testing (PIT) and further investigation may be required in accordance with Article 411-5 of the *2018 Standard Specifications*. A drilled pier will be considered defective in accordance with Subarticle 411-5(D) of the *2018 Standard Specifications* and drilled pier acceptance is based in part on the criteria in Article 411-6 of the *2018 Standard Specifications* except for the top of pier tolerances in Subarticle 411-6(C) of the *2018 Standard Specifications*.

If a drilled pier is under further investigation, do not grout core holes, backfill around the pier or perform any work on the drilled pier until the Engineer accepts the pier. If the drilled pier is accepted, dewater and grout core holes and backfill around the pier with approved material to finished grade. If the Engineer determines a pier is unacceptable, remediation is required in accordance with Article 411-6 of the *2018 Standard Specifications*. No extension of completion date or time will be allowed for remediation of unacceptable drilled piers or post repair testing.

Permanently embed a plate in or mark top of piers with the pier diameter and depth, size and number of vertical reinforcing bars and the minimum compressive strength of the concrete mix at 28 days.

(B) Footings, Pedestals, Grade Beams and Wings

Excavate as necessary for footings, grade beams and wings in accordance with the plans, accepted submittals and Section 410 of the *2018 Standard Specifications*. If unstable, caving or sloughing materials are anticipated or encountered, shore foundation excavations

as needed with an approved method. Notify the Engineer when foundation excavation is complete. Do not place concrete or reinforcing steel until excavation dimensions and foundation material are approved.

Construct cast-in-place reinforced concrete footings, pedestals, grade beams and wings with the dimensions shown in the plans and in accordance with Section 825 of the *2018 Standard Specifications*. Use forms to construct portions of pedestals and grade beams protruding above finished grade. Provide a chamfer with a 3/4" horizontal width for pedestal and grade beam edges exposed above finished grade. Place concrete against undisturbed soil or backfill and fill in accordance with Article 410-8 of the *2018 Standard Specifications*. Proper compaction around footings and wings is critical for foundations to resist uplift and torsion forces.

(C) Anchor Rod Assemblies

Size anchor rods for design and the required projection above top of foundations. Determine required anchor rod projections from nut, washer and base plate thicknesses, the protrusion of 3 to 5 anchor rod threads above top nuts after tightening and the distance of one nut thickness between top of foundations and bottom of leveling nuts.

Protect anchor rod threads from damage during storage and installation of anchor rod assemblies. Before placing anchor rods in foundations, turn nuts onto and off rods past leveling nut locations. Turn nuts with the effort of one workman using an ordinary wrench without a cheater bar. Report any thread damage to the Engineer that requires extra effort to turn nuts.

Arrange anchor rods symmetrically about center of base plate locations as shown in the plans. Set anchor rod elevations based on required projections above top of foundations. Securely brace and hold rods in the correct position, orientation and alignment with a steel template. Do not weld to reinforcing steel, temporary casings or anchor rods.

Install top and leveling (bottom) nuts, washers and the base plate for each anchor rod assembly in accordance with the following procedure:

- (1) Turn leveling nuts onto anchor rods to a distance of one nut thickness between the top of foundation and bottom of leveling nuts. Place washers over anchor rods on top of leveling nuts.
- (2) Determine if nuts are level using a flat rigid template on top of washers. If necessary, lower leveling nuts to level the template in all directions or if applicable, lower nuts to tilt the template so the metal pole or upright truss will lean as shown in the plans. If leveling nuts and washers are not in full contact with the template, replace washers with galvanized beveled washers.
- (3) Verify the distance between the foundation and leveling nuts is no more than one nut thickness.
- (4) Place base plate with metal pole or upright truss over anchor rods on top of washers. High mount luminaires may be attached before erecting metal poles but do not attach cables, mast arms or trusses to metal poles or upright trusses at this time.

- (5) Place washers over anchor rods on top of base plate. Lubricate top nut bearing surfaces and exposed anchor rod threads above washers with beeswax, paraffin or other approved lubricant.
- (6) Turn top nuts onto anchor rods. If nuts are not in full contact with washers or washers are not in full contact with the base plate, replace washers with galvanized beveled washers.
- (7) Tighten top nuts to snug-tight with the full effort of one workman using a 12" wrench. Do not tighten any nut all at once. Turn top nuts in increments. Follow a star pattern cycling through each nut at least twice.
- (8) Repeat (7) for leveling nuts.
- (9) Replace washers above and below the base plate with galvanized beveled washers if the slope of any base plate face exceeds 1:20 (5%), any washer is not in firm contact with the base plate or any nut is not in firm contact with a washer. If any washers are replaced, repeat (7) and (8).
- (10) With top and leveling nuts snug-tight, mark each top nut on a corner at the intersection of 2 flats and a corresponding reference mark on the base plate. Mark top nuts and base plate with ink or paint that is not water-soluble. Use the turn-of-nut method for pretensioning. Do not pretension any nut all at once. Turn top nuts in increments for a total turn that meets the following nut rotation requirements:

NUT ROTATION REQUIREMENTS (Turn-of-Nut Pretensioning Method)	
Anchor Rod Diameter, inch	Requirement
$\leq 1 \frac{1}{2}$	1/3 turn (2 flats)
$> 1 \frac{1}{2}$	1/6 turn (1 flat)

Follow a star pattern cycling through each top nut at least twice.

- (11) Ensure nuts, washers and base plate are in firm contact with each other for each anchor rod. Cables, mast arms and trusses may now be attached to metal poles and upright trusses.
- (12) Between 4 and 14 days after pretensioning top nuts, use a torque wrench calibrated within the last 12 months to check nuts in the presence of the Engineer. Completely erect mast arm poles and cantilever signs and attach any hardware before checking top nuts for these structures. Check that top nuts meet the following torque requirements:

TORQUE REQUIREMENTS	
Anchor Rod Diameter, inch	Requirement, ft-lb
7/8	180
1	270
1 1/8	380
1 1/4	420
$\geq 1 \frac{1}{2}$	600

If necessary, retighten top nuts in the presence of the Engineer with a calibrated torque wrench to within ± 10 ft-lb of the required torque. Do not overtighten top nuts.

- (13) Do not grout under base plate.

Measurement and Payment

Foundations and anchor rod assemblies for metal poles and upright trusses will be measured and paid for elsewhere in the contract.

No payment will be made for temporary casings that remain in drilled pier excavations. No payment will be made for PIT. No payment will be made for further investigation of defective piers. Further investigation of piers that are not defective will be paid as extra work in accordance with Article 104-7 of the *2018 Standard Specifications*. No payment will be made for remediation of unacceptable drilled piers or post repair testing.

HIGH STRENGTH CONCRETE FOR DRIVEWAYS:

(11-21-00) (Rev. 1-17-12)

848

SP10 R02

Use high early strength concrete for all driveways shown in the plans and as directed by the Engineer. Provide high early strength concrete that meets the requirements of Article 1000-5 of the *2018 Standard Specifications*.

Measurement and payment will be in accordance with Section 848 of the *2018 Standard Specifications*.

THERMOPLASTIC PAVEMENT MARKING MATERIAL – COLOR TESTING:

3-19-19

1087

SP10 R05

Revise the *2018 Standard Specifications* as follows:

Pages 10-183 and 10-184, Subarticle 1087-7(D)(1)(b) Yellow, lines 9-11, delete and replace with the following:

Obtain Color Values $Y_{x,y}$ per ASTM E1349 using $C/2^\circ$ illuminant/observer. Results shall be $Y \geq 45\%$, and x,y shall fall within PR#1 chart chromaticity limits.

TEMPORARY SHORING:

(2-20-07) (Rev. 1-16-18)

SP11 R02

Description

Temporary shoring includes cantilever, braced and anchored shoring and temporary mechanically stabilized earth (MSE) walls. Temporary shoring does not include trench boxes. At the Contractor's option, use any type of temporary shoring unless noted otherwise in the plans or as directed. Design and construct temporary shoring based on actual elevations and shoring dimensions in accordance with the contract and accepted submittals. Construct temporary shoring at locations shown in the plans and as directed. Temporary shoring is required to maintain traffic when a 2:1 (H:V) slope from the top of an embankment or bottom of an excavation will intersect the existing ground line less than 5 feet from the edge of pavement of an open travelway. This provision does not apply to pipe, inlet or utility installation unless noted otherwise in the plans.

Positive protection includes concrete barrier and temporary guardrail. Provide positive protection for temporary shoring at locations shown in the plans and as directed. Positive protection is

required if temporary shoring is located in the clear zone in accordance with the *AASHTO Roadside Design Guide*.

(A) Cantilever and Braced Shoring

Cantilever shoring consists of steel sheet piles or H-piles with timber lagging. Braced shoring consists of sheet piles or H-piles with timber lagging and bracing such as beams, plates, walers, struts, rakers, etc. Define “piles” as sheet piles or H-piles.

(B) Anchored Shoring

Anchored shoring consists of sheet piles with walers or H-piles with timber lagging anchored with ground or helical anchors. Driven anchors may be accepted at the discretion of the Engineer. A ground anchor consists of a grouted steel bar or multi-strand tendon with an anchorage. A helical anchor consists of a lead section with a central steel shaft and at least one helix steel plate followed by extensions with only central shafts (no helixes) and an anchorage. Anchorages consist of steel bearing plates with washers and hex nuts for bars or steel wedge plates and wedges for strands. Use a prequalified Anchored Wall Contractor to install ground anchors. Define “anchors” as ground, helical or driven anchors.

(C) Temporary MSE Walls

Temporary MSE walls include temporary geosynthetic and wire walls. Define “temporary wall” as a temporary MSE wall and “Temporary Wall Vendor” as the vendor supplying the temporary MSE wall. Define “reinforcement” as geotextile, geogrid, welded wire grid or metallic strip reinforcement.

Temporary geosynthetic walls consist of geotextile or geogrid reinforcement wrapped behind welded wire facing. Define “temporary geotextile wall” as a temporary geosynthetic wall with geotextile reinforcement and “temporary geogrid wall” as a temporary geosynthetic wall with geogrid reinforcement.

Temporary wire walls consist of welded wire grid or metallic strip reinforcement connected to welded wire facing. Define “Wire Wall Vendor” as the vendor supplying the temporary wire wall.

(D) Embedment

Define “embedment” for cantilever, braced and anchored shoring as the pile depth below the grade in front of shoring. Define “embedment” for temporary walls as the wall height below the grade in front of walls.

(E) Positive Protection

Define “unanchored or anchored portable concrete barrier” as portable concrete barrier (PCB) that meets 2018 Roadway Standard Drawing No. 1170.01. Define “concrete barrier” as unanchored or anchored PCB or an approved equal. Define “temporary

guardrail” as temporary steel beam guardrail that meets 2018 Roadway Standard Drawing No. 862.02.

Materials

Refer to the *2018 Standard Specifications*.

Item	Section
Concrete Barrier Materials	1170-2
Flowable Fill, Excavatable	1000-6
Geosynthetics	1056
Neat Cement Grout	1003
Portland Cement Concrete	1000
Select Materials	1016
Steel Beam Guardrail Materials	862-2
Steel Plates	1072-2
Steel Sheet Piles and H-Piles	1084
Untreated Timber	1082-2
Welded Wire Reinforcement	1070-3

Provide Type 6 material certifications for shoring materials in accordance with Article 106-3 of the *2018 Standard Specifications*. Use Class IV select material for temporary guardrail. Use neat cement grout for Type 2 grout for ground anchors. Use Class A concrete that meets Article 450-2 of the *2018 Standard Specifications* or Type 1 grout for drilled-in piles. Provide untreated timber with a thickness of at least 3 inches and a bending stress of at least 1,000 pounds per square inch for timber lagging. Provide steel bracing that meets ASTM A36.

(A) Shoring Backfill

Use Class II, Type 1, Class III, Class V or Class VI select material or material that meets AASHTO M 145 for soil classification A-2-4 with a maximum PI of 6 for shoring backfill except do not use A-2-4 soil for backfill around culverts.

(B) Anchors

Store anchor materials on blocking a minimum of 12 inches above the ground and protect it at all times from damage; and when placing in the work make sure it is free from dirt, dust, loose mill scale, loose rust, paint, oil or other foreign materials. Load, transport, unload and store anchor materials so materials are kept clean and free of damage. Bent, damaged or defective materials will be rejected.

(1) Ground Anchors

Use high-strength deformed steel bars that meet AASHTO M 275 or seven-wire strands that meet ASTM A886 or Article 1070-5 of the *2018 Standard Specifications*. Splice bars in accordance with Article 1070-9 of the *2018 Standard Specifications*. Do not splice strands. Use bondbreakers, spacers and centralizers that meet Article 6.3.5 of the *AASHTO LRFD Bridge Construction Specifications*.

(2) Helical Anchors

Use helical anchors with an ICC Evaluation Service, Inc. (ICC-ES) report. Provide couplers, thread bar adapters and bolts recommended by the Anchor Manufacturer to connect helical anchors together and to piles.

(3) Anchorages

Provide steel plates for bearing plates and steel washers, hex nuts, wedge plates and wedges recommended by the Anchor Manufacturer.

(C) Temporary Walls

(1) Welded Wire Facing

Use welded wire reinforcement for welded wire facing, struts and wires. For temporary wire walls, provide welded wire facing supplied by the Wire Wall Vendor or a manufacturer approved or licensed by the vendor. For temporary wire walls with separate reinforcement and facing components, provide connectors (e.g., bars, clamps, plates, etc.) and fasteners (e.g., bolts, nuts, washers, etc.) required by the Wire Wall Vendor.

(2) Geotextiles

Provide Type 2 geotextile for separation and retention geotextiles. Provide Type 5 geotextile for geotextile reinforcement with ultimate tensile strengths in accordance with the accepted submittals.

(3) Geogrid Reinforcement

Use geogrids with a roll width of at least 4 feet and an “approved” or “approved for provisional use” status code. The list of approved geogrids is available from: connect.ncdot.gov/resources/Materials/Pages/Materials-Manual-by-Material.aspx

Provide geogrids for geogrid reinforcement with design strengths in accordance with the accepted submittals. Geogrids are typically approved for ultimate tensile strengths in the machine direction (MD) and cross-machine direction (CD) or short-term design strengths for a 3-year design life in the MD based on material type. Define material type from the website above for shoring backfill as follows:

Material Type	Shoring Backfill
Borrow	A-2-4 Soil
Fine Aggregate	Class II, Type 1 or Class III Select Material
Coarse Aggregate	Class V or VI Select Material

(4) Welded Wire Grid and Metallic Strip Reinforcement

Provide welded wire grid and metallic strip reinforcement supplied by the Wire Wall Vendor or a manufacturer approved or licensed by the vendor. Use welded wire grid reinforcement (“mesh”, “mats” and “ladders”) that meet Article 1070-3 of the *2018 Standard Specifications* and metallic strip reinforcement (“straps”) that meet ASTM A572 or A1011.

Preconstruction Requirements

(A) Concrete Barrier

Define “clear distance” behind concrete barrier as the horizontal distance between the barrier and edge of pavement. The minimum required clear distance for concrete barrier is shown in the plans. At the Contractor’s option or if the minimum required clear distance is not available, set concrete barrier next to and up against traffic side of temporary shoring except for barrier above temporary walls. Concrete barrier with the minimum required clear distance is required above temporary walls.

(B) Temporary Guardrail

Define “clear distance” behind temporary guardrail as the horizontal distance between guardrail posts and temporary shoring. At the Contractor’s option or if clear distance for cantilever, braced and anchored shoring is less than 4 feet, attach guardrail to traffic side of shoring as shown in the plans. Place ABC in clear distance and around guardrail posts instead of pavement. Do not use temporary guardrail above temporary walls.

(C) Temporary Shoring Designs

Before beginning temporary shoring design, survey existing ground elevations in the vicinity of shoring locations to determine actual design heights (H). Submit PDF files of working drawings and design calculations for temporary shoring designs in accordance with Article 105-2 of the *2018 Standard Specifications*. Submit working drawings showing plan views, shoring profiles, typical sections and details of temporary shoring design and construction sequence. Do not begin shoring construction until a design submittal is accepted.

Have cantilever and braced shoring designed, detailed and sealed by an engineer licensed in the state of North Carolina. Use a prequalified Anchored Wall Design Consultant to design anchored shoring. Provide anchored shoring designs sealed by a Design Engineer approved as a Geotechnical Engineer (key person) for an Anchored Wall Design Consultant. Include details in anchored shoring working drawings of anchor locations and lock-off loads, unit grout/ground bond strengths for ground anchors or minimum installation torque and torsional strength rating for helical anchors and if necessary, obstructions extending through shoring or interfering with anchors. Include details in the anchored shoring construction sequence of pile and anchor installation, excavation and anchor testing.

Provide temporary wall designs sealed by a Design Engineer licensed in the state of North Carolina and employed or contracted by the Temporary Wall Vendor. Include details in temporary wall working drawings of geotextile and reinforcement types, locations and directions and obstructions extending through walls or interfering with reinforcement.

(1) Soil Parameters

Design temporary shoring for the assumed soil parameters and groundwater elevations shown in the plans. Assume the following soil parameters for shoring backfill:

(a) Unit weight (γ) = 120 pcf;

(b)	Friction Angle (ϕ)	Shoring Backfill
	30°	A-2-4 Soil
	34°	Class II, Type 1 or Class III Select Material
	38°	Class V or VI Select Material

(c) Cohesion (c) = 0 psf.

(2) Traffic Surcharge

Design temporary shoring for a traffic surcharge of 250 pounds per square foot if traffic will be above and within H of shoring. This traffic surcharge does not apply to construction traffic. Design temporary shoring for any construction surcharge if construction traffic will be above and within H of shoring. For LRFD shoring designs, apply traffic (live load) surcharge in accordance with Figure C11.5.5-3 of the *AASHTO LRFD Bridge Design Specifications*.

(3) Cantilever, Braced and Anchored Shoring Designs

Use shoring backfill for fill sections and voids between cantilever, braced and anchored shoring and the critical failure surface. Use concrete or grout for embedded portions of drilled-in H-piles. Do not use drilled-in sheet piles.

Define “top of shoring” for cantilever, braced and anchored shoring as where the grade intersects the back of sheet piles or H-piles and timber lagging. Design cantilever, braced and anchored shoring for a traffic impact load of 2,000 pounds per foot applied 18 inches above top of shoring if concrete barrier is above and next to shoring or temporary guardrail is above and attached to shoring. For anchored shoring designs, apply traffic impact load as horizontal load (P_{HI}) in accordance with Figure 3.11.6.3-2(a) of the *AASHTO LRFD specifications*.

Extend cantilever, braced and anchored shoring at least 32 inches above top of shoring if shoring is designed for traffic impact. Otherwise, extend shoring at least 6 inches above top of shoring.

Design cantilever, braced and anchored shoring for a maximum deflection of 3 inches if the horizontal distance to the closest edge of pavement or structure is less than H. Otherwise, design shoring for a maximum deflection of 6 inches. Design

cantilever and braced shoring in accordance with the plans and *AASHTO Guide Design Specifications for Bridge Temporary Works*.

Design anchored shoring in accordance with the plans and Article 11.9 of the *AASHTO LRFD Bridge Design Specifications*. Use a resistance factor of 0.80 for tensile resistance of anchors with bars, strands or shafts. Extend the unbonded length for ground anchors and the shallowest helix for helical anchors at least 5 feet behind the critical failure surface. Do not extend anchors beyond right-of-way or easement limits. If existing or future obstructions such as foundations, guardrail posts, pavements, pipes, inlets or utilities will interfere with anchors, maintain a clearance of at least 6 inches between obstructions and anchors.

(4) Temporary Wall Designs

Use shoring backfill in the reinforced zone of temporary walls. Separation geotextiles are required between shoring backfill and backfill, natural ground or culverts along the sides of the reinforced zone perpendicular to the wall face. For Class V or VI select material in the reinforced zone, separation geotextiles are also required between shoring backfill and backfill or natural ground on top of and at the back of the reinforced zone.

Design temporary walls in accordance with the plans and Article 11.10 of the *AASHTO LRFD Bridge Design Specifications*. Embed temporary walls at least 18 inches except for walls on structures or rock as determined by the Engineer. Use a uniform reinforcement length throughout the wall height of at least $0.7H$ or 6 feet, whichever is longer. Extend the reinforced zone at least 6 inches beyond end of reinforcement. Do not locate the reinforced zone outside right-of-way or easement limits.

Use the simplified method for determining maximum reinforcement loads in accordance with the AASHTO LRFD specifications. For geotextile reinforcement, use geotextile properties approved by the Department or default values in accordance with the AASHTO LRFD specifications. For geogrid reinforcement, use approved geogrid properties available from the website shown elsewhere in this provision. If the website does not list a short-term design strength for an approved geogrid, use a short-term design strength equal to the ultimate tensile strength divided by 3.5 for the geogrid reinforcement. Use geosynthetic properties for the direction reinforcement will be installed, a 3-year design life and shoring backfill to be used in the reinforced zone.

Do not use more than 4 different reinforcement strengths for each temporary geosynthetic wall. Design temporary geotextile walls for a reinforcement coverage ratio (R_c) of 1.0. For temporary geogrid walls with an R_c of less than 1.0, use a maximum horizontal clearance between geogrids of 3 feet and stagger reinforcement so geogrids are centered over gaps in the reinforcement layer below.

For temporary geosynthetic walls, use “L” shaped welded wire facing with 18 to 24 inch long legs. Locate geotextile or geogrid reinforcement so reinforcement

layers are at the same level as the horizontal legs of welded wire facing. Use vertical reinforcement spacing equal to facing height. Wrap geotextile or geogrid reinforcement behind welded wire facing and extend reinforcement at least 3 feet back behind facing into shoring backfill.

For temporary wire walls with separate reinforcement and facing components, attach welded wire grid or metallic strip reinforcement to welded wire facing with a connection approved by the Department. For temporary geogrid and wire walls, retain shoring backfill at welded wire facing with retention geotextiles and extend geotextiles at least 3 feet back behind facing into backfill.

(D) Preconstruction Meeting

The Engineer may require a shoring preconstruction meeting to discuss the construction, inspection and testing of the temporary shoring. If required and if this meeting occurs before all shoring submittals have been accepted, additional preconstruction meetings may be required before beginning construction of temporary shoring without accepted submittals. The Resident, District or Bridge Maintenance Engineer, Area Construction Engineer, Geotechnical Operations Engineer, Contractor and Shoring Contractor Superintendent will attend preconstruction meetings.

Construction Methods

Control drainage during construction in the vicinity of shoring. Direct run off away from shoring and shoring backfill. Contain and maintain backfill and protect material from erosion.

Install positive protection in accordance with the contract and accepted submittals. Use PCB in accordance with Section 1170 of the *2018 Standard Specifications* and 2018 Roadway Standard Drawing No. 1170.01. Use temporary guardrail in accordance with Section 862 of the *2018 Standard Specifications* and 2018 Roadway Standard Drawing Nos. 862.01, 862.02 and 862.03.

(A) Tolerances

Construct shoring with the following tolerances:

- (1) Horizontal wires of welded wire facing are level in all directions,
- (2) Shoring location is within 6 inches of horizontal and vertical alignment shown in the accepted submittals, and
- (3) Shoring plumbness (batter) is not negative and within 2 degrees of vertical.

(B) Cantilever, Braced and Anchored Shoring Installation

If overexcavation behind cantilever, braced or anchored shoring is shown in the accepted submittals, excavate before installing piles. Otherwise, install piles before excavating for shoring. Install cantilever, braced or anchored shoring in accordance with the construction

sequence shown in the accepted submittals. Remove piles and if applicable, timber lagging when shoring is no longer needed.

(1) Pile Installation

Install piles with the minimum required embedment and extension in accordance with Subarticles 450-3(D) and 450-3(E) of the *2018 Standard Specifications* except that a pile driving equipment data form is not required. Piles may be installed with a vibratory hammer as approved by the Engineer.

Do not splice sheet piles. Use pile excavation to install drilled-in H-piles. After filling holes with concrete or grout to the elevations shown in the accepted submittals, remove any fluids and fill remaining portions of holes with flowable fill. Cure concrete or grout at least 7 days before excavating.

Notify the Engineer if refusal is reached before pile excavation or driven piles attain the minimum required embedment. When this occurs, a revised design submittal may be required.

(2) Excavation

Excavate in front of piles from the top down in accordance with the accepted submittals. For H-piles with timber lagging and braced and anchored shoring, excavate in staged horizontal lifts with a maximum height of 5 feet. Remove flowable fill and material in between H-piles as needed to install timber lagging. Position lagging with at least 3 inches of contact in the horizontal direction between the lagging and pile flanges. Do not excavate the next lift until timber lagging for the current lift is installed and if applicable, bracing and anchors for the current lift are accepted. Backfill behind cantilever, braced or anchored shoring with shoring backfill.

(3) Anchor Installation

If applicable, install foundations located behind anchored shoring before installing anchors. Fabricate and install ground anchors in accordance with the accepted submittals, Articles 6.4 and 6.5 of the *AASHTO LRFD Bridge Construction Specifications* and the following unless otherwise approved:

- (a) Materials in accordance with this provision are required instead of materials conforming to Articles 6.4 and 6.5.3 of the AASHTO LRFD Specifications,
- (b) Encapsulation-protected ground anchors in accordance with Article 6.4.1.2 of the AASHTO LRFD specifications are not required, and
- (c) Corrosion protection for unbonded lengths of ground anchors and anchorage covers are not required.

- (d) Measure grout temperature, density and flow during grouting with at least the same frequency grout cubes are made for compressive strength. Perform density and flow field tests in the presence of the Engineer in accordance with American National Standards Institute/American Petroleum Institute Recommended Practice 13B-1 (Section 4, Mud Balance) and ASTM C939 (Flow Cone), respectively.

Install helical anchors in accordance with the accepted submittals and Anchor Manufacturer's instructions. Measure torque during installation and do not exceed the torsional strength rating of the helical anchor. Attain the minimum required installation torque and penetration before terminating anchor installation. When replacing a helical anchor, embed last helix of the replacement anchor at least 3 helix plate diameters past the location of the first helix of the previous anchor.

(4) Anchor Testing

Proof test and lock-off anchors in accordance with the accepted submittals and Article 6.5.5 of the *AASHTO LRFD Bridge Construction Specifications* except for the acceptance criteria in Article 6.5.5.5. For the AASHTO LRFD specifications, "ground anchor" refers to a ground or helical anchor and "tendon" refers to a bar, strand or shaft.

(a) Anchor Acceptance

Anchor acceptance is based in part on the following criteria.

- (i) For ground and helical anchors, total movement is less than 0.04 inches between the 1 and 10 minute readings or less than 0.08 inches between the 6 and 60 minute readings.
- (ii) For ground anchors, total movement at maximum test load exceeds 80% of the theoretical elastic elongation of the unbonded length.

(b) Anchor Test Results

Submit PDF files of anchor test records including movement versus load plots for each load increment within 24 hours of completing each row of anchors. The Engineer will review the test records to determine if the anchors are acceptable.

If the Engineer determines an anchor is unacceptable, revise the anchor design or installation methods. Submit a revised anchored shoring design for acceptance and provide an acceptable anchor with the revised design or installation methods. If required, replace the anchor or provide additional anchors with the revised design or installation methods.

(C) Temporary Wall Installation

Excavate as necessary for temporary walls in accordance with the plans and accepted submittals. If applicable, install foundations located in the reinforced zone before placing shoring backfill or reinforcement unless otherwise approved. Notify the Engineer when foundation excavation is complete. Do not place shoring backfill or reinforcement until excavation dimensions and foundation material are approved.

Erect welded wire facing so the wall position is as shown in the plans and accepted submittals. Set welded wire facing adjacent to each other in the horizontal and vertical direction to completely cover the wall face with facing. Stagger welded wire facing to create a running bond by centering facing over joints in the row below.

Wrap geotextile reinforcement and retention geotextiles behind welded wire facing as shown in the plans and accepted submittals and cover geotextiles with at least 3" of shoring backfill. Overlap adjacent geotextile reinforcement and retention and separation geotextiles at least 18 inches with seams oriented perpendicular to the wall face. Hold geotextiles in place with wire staples or anchor pins as needed.

Place reinforcement within 3 inches of locations shown in the plans and accepted submittals. Before placing shoring backfill, pull reinforcement taut so it is in tension and free of kinks, folds, wrinkles or creases. Install reinforcement with the direction shown in the plans and accepted submittals. For temporary wire walls with separate reinforcement and facing components, attach welded wire grid or metallic strip reinforcement to welded wire facing as shown in the accepted submittals. Do not splice or overlap reinforcement so seams are parallel to the wall face. Contact the Engineer when unanticipated existing or future obstructions such as foundations, pavements, pipes, inlets or utilities will interfere with reinforcement.

Place shoring backfill in the reinforced zone in 8 to 10 inch thick lifts. Compact A-2-4 soil and Class II, Type 1 and Class III select material in accordance with Subarticle 235-3(C) of the *2018 Standard Specifications*. Use only hand operated compaction equipment to compact backfill within 3 feet of welded wire facing. At a distance greater than 3 feet, compact shoring backfill with at least 4 passes of an 8 to 10 ton vibratory roller in a direction parallel to the wall face. Smooth wheeled or rubber tired rollers are also acceptable for compacting backfill. Do not use sheepsfoot, grid rollers or other types of compaction equipment with feet. Do not displace or damage reinforcement when placing and compacting shoring backfill. End dumping directly on geotextile or geogrid reinforcement is not permitted. Do not operate heavy equipment on reinforcement until it is covered with at least 8 inches of shoring backfill. Replace any damaged reinforcement to the satisfaction of the Engineer.

Backfill for temporary walls outside the reinforced zone in accordance with Article 410-8 of the *2018 Standard Specifications*. Bench temporary walls into the sides of excavations where applicable. For temporary geosynthetic walls with top of wall within 5 feet of finished grade, remove top facing and incorporate top reinforcement layer into fill when placing fill in front of wall. Temporary walls remain in place permanently unless otherwise required.

Measurement and Payment

Temporary Shoring will be measured and paid in square feet. Temporary walls will be measured as the square feet of exposed wall face area. Cantilever, braced or anchored shoring will be measured as the square feet of exposed shoring face area with the shoring height equal to the difference between the top and bottom of shoring elevations. Define “top of shoring” as where the grade intersects the back of sheet piles or H-piles and timber lagging. Define “bottom of shoring” as where the grade intersects front of sheet piles or H-piles and timber lagging. No measurement will be made for any embedment, shoring extension above top of shoring or pavement thickness above temporary walls.

The contract unit price for *Temporary Shoring* will be full compensation for providing shoring designs, submittals and materials, excavating, backfilling, hauling and removing excavated materials and supplying all labor, tools, equipment and incidentals necessary to construct temporary shoring.

No payment will be made for temporary shoring not shown in the plans or required by the Engineer including shoring for OSHA reasons or the Contractor’s convenience. No value engineering proposals will be accepted based solely on revising or eliminating shoring locations shown in the plans or estimated quantities shown in the bid item sheets as a result of actual field measurements or site conditions.

PCB will be measured and paid in accordance with Section 1170 of the *2018 Standard Specifications*. No additional payment will be made for anchoring PCB for temporary shoring. Costs for anchoring PCB will be incidental to temporary shoring.

Temporary guardrail will be measured and paid for in accordance with Section 862 of the *2018 Standard Specifications*.

Payment will be made under:

Pay Item	Pay Unit
Temporary Shoring	Square Foot

EXTRUDED THERMOPLASTIC PAVEMENT MARKING THICKNESS:

3-19-19

1205

SP12 R05

Revise the *2018 Standard Specifications* as follows:

Page 12-6, Subarticle 1205-4(A)(1) General, lines 5-8, delete the second sentence and replace with the following:

Use application equipment that provides multiple width settings ranging from 4 inches to 12 inches and multiple thickness settings to achieve a minimum pavement marking thickness of 0.090 inch above the surface of the pavement.

Page 12-7, Table 1205-3, THICKNESS REQUIREMENTS FOR THERMOPLASTIC, replace with the following:

TABLE 1205-3 MINIMUM THICKNESS REQUIREMENTS FOR THERMOPLASTIC	
Thickness	Location
240 mils	In-lane and shoulder-transverse pavement markings (rumble strips). May be placed in 2 passes.
90 mils	Center lines, skip lines, transverse bands, mini-skip lines, characters, bike lane symbols, crosswalk lines, edge lines, gore lines, diagonals, and arrow symbols

PERMANENT SEEDING AND MULCHING:

(7-1-95)

1660

SP16 R02

The Department desires that permanent seeding and mulching be established on this project as soon as practical after slopes or portions of slopes have been graded. As an incentive to obtain an early stand of vegetation on this project, the Contractor's attention is called to the following:

For all permanent seeding and mulching that is satisfactorily completed in accordance with the requirements of Section 1660 in the *2018 Standard Specifications* and within the following percentages of elapsed contract times, an additional payment will be made to the Contractor as an incentive additive. The incentive additive will be determined by multiplying the number of acres of seeding and mulching satisfactorily completed times the contract unit bid price per acre for Seeding and Mulching times the appropriate percentage additive.

Percentage of Elapsed Contract Time	Percentage Additive
0% - 30%	30%
30.01% - 50%	15%

Percentage of elapsed contract time is defined as the number of calendar days from the date of availability of the contract to the date the permanent seeding and mulching is acceptably completed divided by the total original contract time.

STANDARD SPECIAL PROVISION
AVAILABILITY OF FUNDS – TERMINATION OF CONTRACTS

(5-20-08)

Z-2

General Statute 143C-6-11. (h) Highway Appropriation is hereby incorporated verbatim in this contract as follows:

(h) Amounts Encumbered. – Transportation project appropriations may be encumbered in the amount of allotments made to the Department of Transportation by the Director for the estimated payments for transportation project contract work to be performed in the appropriation fiscal year. The allotments shall be multiyear allotments and shall be based on estimated revenues and shall be subject to the maximum contract authority contained in *General Statute 143C-6-11(c)*. Payment for transportation project work performed pursuant to contract in any fiscal year other than the current fiscal year is subject to appropriations by the General Assembly. Transportation project contracts shall contain a schedule of estimated completion progress, and any acceleration of this progress shall be subject to the approval of the Department of Transportation provided funds are available. The State reserves the right to terminate or suspend any transportation project contract, and any transportation project contract shall be so terminated or suspended if funds will not be available for payment of the work to be performed during that fiscal year pursuant to the contract. In the event of termination of any contract, the contractor shall be given a written notice of termination at least 60 days before completion of scheduled work for which funds are available. In the event of termination, the contractor shall be paid for the work already performed in accordance with the contract specifications.

Payment will be made on any contract terminated pursuant to the special provision in accordance with Subarticle 108-13(D) of the *2018 Standard Specifications*.

STANDARD SPECIAL PROVISION
NCDOT GENERAL SEED SPECIFICATION FOR SEED QUALITY

(5-17-11)

Z-3

Seed shall be sampled and tested by the North Carolina Department of Agriculture and Consumer Services, Seed Testing Laboratory. When said samples are collected, the vendor shall supply an independent laboratory report for each lot to be tested. Results from seed so sampled shall be final. Seed not meeting the specifications shall be rejected by the Department of Transportation and shall not be delivered to North Carolina Department of Transportation warehouses. If seed has been delivered it shall be available for pickup and replacement at the supplier's expense.

Any re-labeling required by the North Carolina Department of Agriculture and Consumer Services, Seed Testing Laboratory, that would cause the label to reflect as otherwise specified herein shall be rejected by the North Carolina Department of Transportation.

Seed shall be free from seeds of the noxious weeds Johnsongrass, Balloonvine, Jimsonweed, Witchweed, Itchgrass, Serrated Tussock, Showy Crotalaria, Smooth Crotalaria, Sicklepod, Sandbur, Wild Onion, and Wild Garlic. Seed shall not be labeled with the above weed species on the seed analysis label. Tolerances as applied by the Association of Official Seed Analysts will NOT be allowed for the above noxious weeds except for Wild Onion and Wild Garlic.

Tolerances established by the Association of Official Seed Analysts will generally be recognized. However, for the purpose of figuring pure live seed, the found pure seed and found germination percentages as reported by the North Carolina Department of Agriculture and Consumer Services, Seed Testing Laboratory will be used. Allowances, as established by the NCDOT, will be recognized for minimum pure live seed as listed on the following pages.

The specifications for restricted noxious weed seed refers to the number per pound as follows:

<u>Restricted Noxious Weed</u>	<u>Limitations per Lb. Of Seed</u>	<u>Restricted Noxious Weed</u>	<u>Limitations per Lb. of Seed</u>
Blessed Thistle	4 seeds	Cornflower (Ragged Robin)	27 seeds
Cocklebur	4 seeds	Texas Panicum	27 seeds
Spurred Anoda	4 seeds	Bracted Plantain	54 seeds
Velvetleaf	4 seeds	Buckhorn Plantain	54 seeds
Morning-glory	8 seeds	Broadleaf Dock	54 seeds
Corn Cockle	10 seeds	Curly Dock	54 seeds
Wild Radish	12 seeds	Dodder	54 seeds
Purple Nutsedge	27 seeds	Giant Foxtail	54 seeds
Yellow Nutsedge	27 seeds	Horsenettle	54 seeds
Canada Thistle	27 seeds	Quackgrass	54 seeds
Field Bindweed	27 seeds	Wild Mustard	54 seeds
Hedge Bindweed	27 seeds		

Seed of Pensacola Bahiagrass shall not contain more than 7% inert matter, Kentucky Bluegrass, Centipede and Fine or Hard Fescue shall not contain more than 5% inert matter whereas a maximum of 2% inert matter will be allowed on all other kinds of seed. In addition, all seed shall

not contain more than 2% other crop seed nor more than 1% total weed seed. The germination rate as tested by the North Carolina Department of Agriculture shall not fall below 70%, which includes both dormant and hard seed. Seed shall be labeled with not more than 7%, 5% or 2% inert matter (according to above specifications), 2% other crop seed and 1% total weed seed.

Exceptions may be made for minimum pure live seed allowances when cases of seed variety shortages are verified. Pure live seed percentages will be applied in a verified shortage situation. Those purchase orders of deficient seed lots will be credited with the percentage that the seed is deficient.

FURTHER SPECIFICATIONS FOR EACH SEED GROUP ARE GIVEN BELOW:

Minimum 85% pure live seed; maximum 1% total weed seed; maximum 2% total other crop seed; maximum 144 restricted noxious weed seed per pound. Seed less than 83% pure live seed will not be approved.

Sericea Lespedeza
Oats (seeds)

Minimum 80% pure live seed; maximum 1% total weed seed; maximum 2% total other crop; maximum 144 restricted noxious weed seed per pound. Seed less than 78% pure live seed will not be approved.

Tall Fescue (all approved varieties)	Bermudagrass
Kobe Lespedeza	Browntop Millet
Korean Lespedeza	German Millet – Strain R
Weeping Lovegrass	Clover – Red/White/Crimson
Carpetgrass	

Minimum 78% pure live seed; maximum 1% total weed seed; maximum 2% total other crop seed; maximum 144 restricted noxious weed seed per pound. Seed less than 76% pure live seed will not be approved.

Common or Sweet Sundangrass

Minimum 76% pure live seed; maximum 1% total weed seed; maximum 2% total other crop seed; maximum 144 restricted noxious weed seed per pound. Seed less than 74% pure live seed will not be approved.

Rye (grain; all varieties)
Kentucky Bluegrass (all approved varieties)
Hard Fescue (all approved varieties)
Shrub (bicolor) Lespedeza

Minimum 70% pure live seed; maximum 1% total weed seed; maximum 2% total other crop seed; maximum 144 noxious weed seed per pound. Seed less than 70% pure live seed will not be approved.

Centipedegrass	Japanese Millet
Crownvetch	Reed Canary Grass
Pensacola Bahiagrass	Zoysia
Creeping Red Fescue	

Minimum 70% pure live seed; maximum 1% total weed seed; maximum 2% total other crop seed; maximum 5% inert matter; maximum 144 restricted noxious weed seed per pound.

Barnyard Grass
Big Bluestem
Little Bluestem
Bristly Locust
Birdsfoot Trefoil
Indiangrass
Orchardgrass
Switchgrass
Yellow Blossom Sweet Clover

STANDARD SPECIAL PROVISION**ERRATA**

(10-16-18) (Rev.1-15-19)

Z-4

Revise the *2018 Standard Specifications* as follows:

Division 6

Page 6-7, Article 609-1 DESCRIPTION, line 29, replace article number “609-10” with “609-9”.

Division 7

Page 7-27, Article 725-1 MEASUREMENT AND PAYMENT, line 4, replace article number “725-1” with “724-4”.

Page 7-28, Article 725-1 MEASUREMENT AND PAYMENT, line 10, replace article number “725-1” with “725-3”.

Division 10

Page 10-78, Article 1056-4 GEOTEXTILES, TABLE 1056-1, Permittivity, Type 2, replace “Table 6^D” with “Table 7^D” and **Permittivity, Type 3^B,** replace “Table 7^D” with “Table 8^D”.

Page 10-162, Article 1080-50 PAINT FOR VERTICAL MARKERS, line 1, replace article number “1080-50” with “1080-10”.

Page 10-162, Article 1080-61 EPOXY RESIN FOR REINFORCING STEEL, line 5, replace article number “1080-61” with “1080-11”.

Page 10-162, Article 1080-72 ABRASIVE MATERIALS FOR BLAST CLEANING STEEL, line 22, replace article number “1080-72” with “1080-12”.

Page 10-163, Article 1080-83 FIELD PERFORMANCE AND SERVICES, line 25, replace article number “1080-83” with “1080-13”.

Division 17

Page 17-15, Article 1715-4 MEASUREMENT AND PAYMENT, lines 42-44, replace the second sentence with the following:

An example is an installation of a single 1.25 inch HDPE conduit would be paid as:

Directional Drill (1)(1.25”) Linear Foot

STANDARD SPECIAL PROVISION**PLANT AND PEST QUARANTINES****(Imported Fire Ant, Gypsy Moth, Witchweed, Emerald Ash Borer, Guava Root Knot Nematode, And Other Noxious Weeds)**

(3-18-03) (Rev. 5-21-19)

Z-04a

Within Quarantined Area

This project may be within a county regulated for plant and/or pests. If the project or any part of the Contractor's operations is located within a quarantined area, thoroughly clean all equipment prior to moving out of the quarantined area. Comply with federal/state regulations by obtaining a certificate or limited permit for any regulated article moving from the quarantined area.

Originating in a Quarantined County

Obtain a certificate or limited permit issued by the N.C. Department of Agriculture/United States Department of Agriculture. Have the certificate or limited permit accompany the article when it arrives at the project site.

Contact

Contact the N.C. Department of Agriculture/United States Department of Agriculture at 1-800-206-9333, 919-707-3730, or <https://www.ncagr.gov/plantindustry/Plant/quaran/table2.htm> to determine those specific project sites located in the quarantined area or for any regulated article used on this project originating in a quarantined county.

Regulated Articles Include

1. Soil, sand, gravel, compost, peat, humus, muck, and decomposed manure, separately or with other articles. This includes movement of articles listed above that may be associated with cut/waste, ditch pulling, and shoulder cutting.
2. Plants with roots including grass sod.
3. Plant crowns and roots.
4. Bulbs, corms, rhizomes, and tubers of ornamental plants.
5. Hay, straw, fodder, and plant litter of any kind.
6. Clearing and grubbing debris.
7. Used agricultural cultivating and harvesting equipment.
8. Used earth-moving equipment.
9. Any other products, articles, or means of conveyance, of any character, if determined by an inspector to present a hazard of spreading imported fire ant, gypsy moth, witchweed, emerald ash borer, guava root knot nematode, or other noxious weeds.

STANDARD SPECIAL PROVISION

MINIMUM WAGES

(7-21-09)

Z-5

FEDERAL: The Fair Labor Standards Act provides that with certain exceptions every employer shall pay wages at the rate of not less than SEVEN DOLLARS AND TWENTY FIVE CENTS (\$7.25) per hour.

STATE: The North Carolina Minimum Wage Act provides that every employer shall pay to each of his employees, wages at a rate of not less than SEVEN DOLLARS AND TWENTY FIVE CENTS (\$7.25) per hour.

The minimum wage paid to all skilled labor employed on this contract shall be SEVEN DOLLARS AND TWENTY FIVE CENTS (\$7.25) per hour.

The minimum wage paid to all intermediate labor employed on this contract shall be SEVEN DOLLARS AND TWENTY FIVE CENTS (\$7.25) per hour.

The minimum wage paid to all unskilled labor on this contract shall be SEVEN DOLLARS AND TWENTY FIVE CENTS (\$7.25) per hour.

This determination of the intent of the application of this act to the contract on this project is the responsibility of the Contractor.

The Contractor shall have no claim against the Department of Transportation for any changes in the minimum wage laws, Federal or State. It is the responsibility of the Contractor to keep fully informed of all Federal and State Laws affecting his contract.

STANDARD SPECIAL PROVISION**TITLE VI AND NONDISCRIMINATION:**

(6-28-77)(Rev 6/19/2018)

Z-6

Revise the *2018 Standard Specifications* as follows:

Replace Article 103-4(B) with the following:

The North Carolina Department of Transportation is committed to carrying out the U.S. Department of Transportation's policy of ensuring nondiscrimination in the award and administration of contracts.

The provisions of this section related to United States Department of Transportation (US DOT) Order 1050.2A, Title 49 Code of Federal Regulations (CFR) part 21, 23 United States Code (U.S.C.) 140 and 23 CFR part 200 (or 49 CFR 303, 49 U.S.C. 5332 or 49 U.S.C. 47123) are applicable to all North Carolina Department of Transportation (NCDOT) contracts and to all related subcontracts, material supply, engineering, architectural and other service contracts, regardless of dollar amount. Any Federal provision that is specifically required not specifically set forth is hereby incorporated by reference.

(1) **Title VI Assurances (USDOT Order 1050.2A, Appendix A)**

During the performance of this contract, the contractor, for itself, its assignees, and successors in interest (hereinafter referred to as the "contractor") agrees as follows:

(a) Compliance with Regulations

The contractor (hereinafter includes consultants) shall comply with the Acts and the Regulations relative to Nondiscrimination in Federally-assisted programs of the U.S. Department of Transportation, Federal Highway Administration (FHWA), as they may be amended from time to time, which are herein incorporated by reference and made a part of this contract.

(b) Nondiscrimination

The contractor, with regard to the work performed by it during the contract, shall not discriminate on the grounds of race, color, or national origin in the selection and retention of subcontractors, including procurements of materials and leases of equipment. The contractor shall not participate directly or indirectly in the discrimination prohibited by the Acts and the Regulations, including employment practices when the contract covers any activity, project, or program set forth in Appendix B of 49 CFR Part 21.

(c) Solicitations for Subcontractors, Including Procurements of Materials and Equipment

In all solicitations, either by competitive bidding, or negotiation made by the contractor for work to be performed under a subcontract, including procurements of materials, or leases of equipment, each potential subcontractor or supplier shall be notified by the contractor of the contractor's obligations under this contract and the Acts and the Regulations relative to Nondiscrimination on the grounds of race, color, or national origin.

(d) Information and Reports

The contractor shall provide all information and reports required by the Acts, the Regulations, and directives issued pursuant thereto and shall permit access to its books, records, accounts, other sources of information, and its facilities as may be determined by the Recipient or the FHWA to be pertinent to ascertain compliance with such Acts,

Regulations, and instructions. Where any information required of a contractor is in the exclusive possession of another who fails or refuses to furnish the information, the contractor shall so certify to the Recipient or the FHWA, as appropriate, and shall set forth what efforts it has made to obtain the information.

(e) Sanctions for Noncompliance:

In the event of a contractor's noncompliance with the Non-discrimination provisions of this contract, the Recipient will impose such contract sanctions as it and/or the FHWA may determine to be appropriate, including, but not limited to:

- (i) Withholding payments to the contractor under the contract until the contractor complies; and/or
- (ii) Cancelling, terminating, or suspending a contract, in whole or in part.

(f) Incorporation of Provisions

The contractor shall include the provisions of paragraphs (a) through (f) in every subcontract, including procurements of materials and leases of equipment, unless exempt by the Acts, the Regulations and directives issued pursuant thereto. The contractor shall take action with respect to any subcontract or procurement as the Recipient or the FHWA may direct as a means of enforcing such provisions including sanctions for noncompliance. Provided, that if the contractor becomes involved in, or is threatened with litigation by a subcontractor, or supplier because of such direction, the contractor may request the Recipient to enter into any litigation to protect the interests of the Recipient. In addition, the contractor may request the United States to enter into the litigation to protect the interests of the United States.

(2) **Title VI Nondiscrimination Program (23 CFR 200.5(p))**

The North Carolina Department of Transportation (NCDOT) has assured the USDOT that, as a condition to receiving federal financial assistance, NCDOT will comply with Title VI of the Civil Rights Act of 1964 and all requirements imposed by Title 49 CFR part 21 and related nondiscrimination authorities to ensure that no person shall, on the ground of race, color, national origin, limited English proficiency, sex, age, or disability (including religion/creed or income-level, where applicable), be excluded from participation in, be denied the benefits of, or be subjected to discrimination under any programs, activities, or services conducted or funded by NCDOT. Contractors and other organizations under contract or agreement with NCDOT must also comply with Title VI and related authorities, therefore:

(a) During the performance of this contract or agreement, contractors (e.g., subcontractors, consultants, vendors, prime contractors) are responsible for complying with NCDOT's Title VI Program. Contractors are not required to prepare or submit Title VI Programs. To comply with this section, the prime contractor shall:

1. Post NCDOT's Notice of Nondiscrimination and the Contractor's own Equal Employment Opportunity (EEO) Policy in conspicuous locations accessible to all employees, applicants and subcontractors on the jobsite.
2. Physically incorporate the required Title VI clauses into all subcontracts on federally-assisted and state-funded NCDOT projects, and ensure inclusion by subcontractors into all lower-tier subcontracts.
3. Required Solicitation Language. The Contractor shall include the following notification in all solicitations for bids and requests for work or material, regardless of funding source:

“The North Carolina Department of Transportation, in accordance with the provisions of Title VI of the Civil Rights Act of 1964 (78 Stat. 252, 42 US.C. §§

2000d to 2000d-4) and the Regulations, hereby notifies all bidders that it will affirmatively ensure that any contract entered into pursuant to this advertisement, disadvantaged business enterprises will be afforded full and fair opportunity to submit bids in response to this invitation and will not be discriminated against on the grounds of race, color, or national origin in consideration for an award. In accordance with other related nondiscrimination authorities, bidders and contractors will also not be discriminated against on the grounds of sex, age, disability, low-income level, creed/religion, or limited English proficiency in consideration for an award.”

4. Physically incorporate the FHWA-1273, in its entirety, into all subcontracts and subsequent lower tier subcontracts on Federal-aid highway construction contracts only.
 5. Provide language assistance services (i.e., written translation and oral interpretation), free of charge, to LEP employees and applicants. Contact NCDOT OCR for further assistance, if needed.
 6. For assistance with these Title VI requirements, contact the NCDOT Title VI Nondiscrimination Program at 1-800-522-0453.
- (b) Subrecipients (e.g. cities, counties, LGAs, planning organizations) may be required to prepare and submit a Title VI Plan to NCDOT, including Title VI Assurances and/or agreements. Subrecipients must also ensure compliance by their contractors and subrecipients with Title VI. (23 CFR 200.9(b)(7))
- (c) If reviewed or investigated by NCDOT, the contractor or subrecipient agrees to take affirmative action to correct any deficiencies found within a reasonable time period, not to exceed 90 calendar days, unless additional time is granted by NCDOT. (23 CFR 200.9(b)(15))
- (d) The Contractor is responsible for notifying subcontractors of NCDOT’s External Discrimination Complaints Process.
1. Applicability
Title VI and related laws protect participants and beneficiaries (e.g., members of the public and contractors) from discrimination by NCDOT employees, subrecipients and contractors, regardless of funding source.
 2. Eligibility
Any person—or class of persons—who believes he/she has been subjected to discrimination based on race, color, national origin, Limited English Proficiency (LEP), sex, age, or disability (and religion in the context of employment, aviation, or transit) may file a written complaint. The law also prohibits intimidation or retaliation of any sort.
 3. Time Limits and Filing Options
Complaints may be filed by the affected individual(s) or a representative and must be filed no later than 180 calendar days after the following:
 - (i) The date of the alleged act of discrimination; or
 - (ii) The date when the person(s) became aware of the alleged discrimination; or
 - (iii) Where there has been a continuing course of conduct, the date on which that conduct was discontinued or the latest instance of the conduct.Title VI and related discrimination complaints may be submitted to the following entities:

- North Carolina Department of Transportation, Office of Civil Rights, Title VI Program, 1511 Mail Service Center, Raleigh, NC 27699-1511; toll free 1-800-522-0453
 - Federal Highway Administration, North Carolina Division Office, 310 New Bern Avenue, Suite 410, Raleigh, NC 27601, 919-747-7010
 - US Department of Transportation, Departmental Office of Civil Rights, External Civil Rights Programs Division, 1200 New Jersey Avenue, SE, Washington, DC 20590; 202-366-4070
4. Format for Complaints
Complaints must be in writing and signed by the complainant(s) or a representative, and include the complainant's name, address, and telephone number. Complaints received by fax or e-mail will be acknowledged and processed. Allegations received by telephone will be reduced to writing and provided to the complainant for confirmation or revision before processing. Complaints will be accepted in other languages, including Braille.
5. Discrimination Complaint Form
Contact NCDOT Civil Rights to receive a full copy of the Discrimination Complaint Form and procedures.
6. Complaint Basis
Allegations must be based on issues involving race, color, national origin (LEP), sex, age, disability, or religion (in the context of employment, aviation or transit). "Basis" refers to the complainant's membership in a protected group category.

**TABLE 103-1
COMPLAINT BASIS**

Protected Categories	Definition	Examples	Applicable Nondiscrimination Authorities
Race and Ethnicity	An individual belonging to one of the accepted racial groups; or the perception, based usually on physical characteristics that a person is a member of a racial group	Black/African American, Hispanic/Latino, Asian, American Indian/Alaska Native, Native Hawaiian/Pacific Islander, White	Title VI of the Civil Rights Act of 1964; 49 CFR Part 21; 23 CFR 200; 49 U.S.C. 5332(b); 49 U.S.C. 47123. (<i>Executive Order 13166</i>)
Color	Color of skin, including shade of skin within a racial group	Black, White, brown, yellow, etc.	
National Origin (<i>Limited English Proficiency</i>)	Place of birth. Citizenship is not a factor. (<i>Discrimination based on language or a person's accent is also covered</i>)	Mexican, Cuban, Japanese, Vietnamese, Chinese	
Sex	Gender. The sex of an individual. <i>Note: Sex under this program does not include sexual orientation.</i>	Women and Men	1973 Federal-Aid Highway Act; 49 U.S.C. 5332(b); 49 U.S.C. 47123.
Age	Persons of any age	21-year-old person	Age Discrimination Act of 1975 49 U.S.C. 5332(b); 49 U.S.C. 47123.
Disability	Physical or mental impairment, permanent or temporary, or perceived.	Blind, alcoholic, para-amputee, epileptic, diabetic, arthritic	Section 504 of the Rehabilitation Act of 1973; Americans with Disabilities Act of 1990

<p>Religion (in the context of employment) <i>(Religion/ Creed in all aspects of any aviation or transit-related construction)</i></p>	<p>An individual belonging to a religious group; or the perception, based on distinguishable characteristics that a person is a member of a religious group. In practice, actions taken as a result of the moral and ethical beliefs as to what is right and wrong, which are sincerely held with the strength of traditional religious views. Note: Does not have to be associated with a recognized religious group or church; if an individual sincerely holds to the belief, it is a protected religious practice.</p>	<p>Muslim, Christian, Sikh, Hindu, etc.</p>	<p>Title VII of the Civil Rights Act of 1964; 23 CFR 230; FHWA-1273 Required Contract Provisions. <i>(49 U.S.C. 5332(b); 49 U.S.C. 47123)</i></p>
--	---	---	---

(3) Pertinent Nondiscrimination Authorities

During the performance of this contract, the contractor, for itself, its assignees, and successors in interest agrees to comply with the following non-discrimination statutes and authorities, including, but not limited to:

- (a) Title VI of the Civil Rights Act of 1964 (42 U.S.C. § 2000d et seq., 78 stat. 252), (prohibits discrimination on the basis of race, color, national origin); and 49 CFR Part 21.
- (b) The Uniform Relocation Assistance and Real Property Acquisition Policies Act of 1970, (42 U.S.C. § 4601), (prohibits unfair treatment of persons displaced or whose property has been acquired because of Federal or Federal-aid programs and projects);
- (c) Federal-Aid Highway Act of 1973, (23 U.S.C. § 324 et seq.), (prohibits discrimination on the basis of sex);
- (d) Section 504 of the Rehabilitation Act of 1973, (29 U.S.C. § 794 et seq.), as amended, (prohibits discrimination on the basis of disability) and 49 CFR Part 27;
- (e) The Age Discrimination Act of 1975, as amended, (42 U.S.C. § 6101 et seq.), (prohibits discrimination on the basis of age);
- (f) Airport and Airway Improvement Act of 1982, (49 USC § 471, Section 47123), as amended, (prohibits discrimination based on race, creed, color, national origin, or sex);
- (g) The Civil Rights Restoration Act of 1987, (PL 100-209), (Broadened the scope, coverage and applicability of Title VI of the Civil Rights Act of 1964, The Age Discrimination Act of 1975 and Section 504 of the Rehabilitation Act of 1973, by expanding the definition of the terms "programs or activities" to include all of the programs or activities of the Federal-aid recipients, sub-recipients and contractors, whether such programs or activities are Federally funded or not);
- (h) Titles II and III of the Americans with Disabilities Act, which prohibit discrimination on the basis of disability in the operation of public entities, public and private transportation systems, places of public accommodation, and certain testing entities (42 U.S.C. §§ 12131-12189) as implemented by Department of Transportation regulations at 49 C.F.R. parts 37 and 38;
- (i) The Federal Aviation Administration's Nondiscrimination statute (49 U.S.C. § 47123) (prohibits discrimination on the basis of race, color, national origin, and sex);
- (j) Executive Order 12898, Federal Actions to Address Environmental Justice in Minority Populations and Low-Income Populations, which ensures Nondiscrimination against minority populations by discouraging programs, policies, and activities with

- disproportionately high and adverse human health or environmental effects on minority and low-income populations;
- (k) Executive Order 13166, Improving Access to Services for Persons with Limited English Proficiency, and resulting agency guidance, national origin discrimination includes discrimination because of Limited English proficiency (LEP). To ensure compliance with Title VI, you must take reasonable steps to ensure that LEP persons have meaningful access to your programs (70 Fed. Reg. at 74087 to 74100);
 - (l) Title IX of the Education Amendments of 1972, as amended, which prohibits you from discriminating because of sex in education programs or activities (20 U.S.C. 1681 et seq).
 - (m) Title VII of the Civil Rights Act of 1964 (42 U.S.C. § 2000e et seq., Pub. L. 88-352), (prohibits employment discrimination on the basis of race, color, religion, sex, or national origin).
- (4) **Additional Title VI Assurances**

***The following Title VI Assurances (Appendices B, C and D) shall apply, as applicable*

- (a) Clauses for Deeds Transferring United States Property (1050.2A, Appendix B)
The following clauses will be included in deeds effecting or recording the transfer of real property, structures, or improvements thereon, or granting interest therein from the United States pursuant to the provisions of Assurance 4.

NOW, THEREFORE, the U.S. Department of Transportation as authorized by law and upon the condition that the North Carolina Department of Transportation (NCDOT) will accept title to the lands and maintain the project constructed thereon in accordance with the North Carolina General Assembly, the Regulations for the Administration of the Federal-Aid Highway Program, and the policies and procedures prescribed by the Federal Highway Administration of the U.S. Department of Transportation in accordance and in compliance with all requirements imposed by Title 49, Code of Federal Regulations, U.S. Department of Transportation, Subtitle A, Office of the Secretary, Part 21, Nondiscrimination in Federally-assisted programs of the U.S. Department of Transportation pertaining to and effectuating the provisions of Title VI of the Civil Rights Act of 1964 (78 Stat. 252; 42 U.S.C. § 2000d to 2000d-4), does hereby remise, release, quitclaim and convey unto the NCDOT all the right, title and interest of the U.S. Department of Transportation in and to said lands described in Exhibit A attached hereto and made a part hereof.

(HABENDUM CLAUSE)

TO HAVE AND TO HOLD said lands and interests therein unto the North Carolina Department of Transportation (NCDOT) and its successors forever, subject, however, to the covenants, conditions, restrictions and reservations herein contained as follows, which will remain in effect for the period during which the real property or structures are used for a purpose for which Federal financial assistance is extended or for another purpose involving the provision of similar services or benefits and will be binding on the NCDOT, its successors and assigns.

The NCDOT, in consideration of the conveyance of said lands and interests in lands, does hereby covenant and agree as a covenant running with the land for itself, its successors and assigns, that (1) no person will on the grounds of race, color, or national origin, be excluded from participation in, be denied the benefits of, or be otherwise subjected to discrimination with regard to any facility located wholly or in part on, over, or under such lands hereby conveyed [,] [and]* (2) that the NCDOT will use the lands and interests in lands and interests in lands so conveyed, in compliance with all requirements imposed by or pursuant to Title 49, Code of Federal Regulations, U.S. Department of Transportation, Subtitle A, Office of the Secretary, Part 21, Non-discrimination in Federally-assisted programs of the U.S. Department of Transportation, Effectuation of Title VI of the Civil Rights Act of 1964, and as said Regulations and Acts may be amended [,] and (3) that in the event of breach of any of the above-mentioned nondiscrimination conditions, the Department will have a right to enter or re-enter said lands and facilities on said land, and that above described land and facilities will thereon revert to and vest in and become the absolute property of the U.S. Department of Transportation and its assigns as such interest existed prior to this instruction].*

(*Reverter clause and related language to be used only when it is determined that such a clause is necessary in order to make clear the purpose of Title VI.)

(b) Clauses for Transfer of Real Property Acquired or Improved Under the Activity, Facility, or Program (1050.2A, Appendix C)

The following clauses will be included in deeds, licenses, leases, permits, or similar instruments entered into by the North Carolina Department of Transportation (NCDOT) pursuant to the provisions of Assurance 7(a):

1. The (grantee, lessee, permittee, etc. as appropriate) for himself/herself, his/her heirs, personal representatives, successors in interest, and assigns, as a part of the consideration hereof, does hereby covenant and agree [in the case of deeds and leases add "as a covenant running with the land"] that:
 - (i.) In the event facilities are constructed, maintained, or otherwise operated on the property described in this (deed, license, lease, permit, etc.) for a purpose for which a U.S. Department of Transportation activity, facility, or program is extended or for another purpose involving the provision of similar services or benefits, the (grantee, licensee, lessee, permittee, etc.) will maintain and operate such facilities and services in compliance with all requirements imposed by the Acts and Regulations (as may be amended) such that no person on the grounds of race, color, or national origin, will be excluded from participation in, denied the benefits of, or be otherwise subjected to discrimination in the use of said facilities.
2. With respect to licenses, leases, permits, etc., in the event of breach of any of the above Nondiscrimination covenants, the NCDOT will have the right to terminate the (lease, license, permit, etc.) and to enter, re-enter, and repossess said lands and facilities thereon, and hold the same as if the (lease, license, permit, etc.) had never been made or issued. *
3. With respect to a deed, in the event of breach of any of the above Nondiscrimination covenants, the NCDOT will have the right to enter or re-enter the lands and facilities thereon, and the above described lands and facilities will there upon revert to and vest in and become the absolute property of the NCDOT and its assigns. *

(*Reverter clause and related language to be used only when it is determined that such a clause is necessary to make clear the purpose of Title VI.)

(c) Clauses for Construction/Use/Access to Real Property Acquired Under the Activity, Facility or Program (1050.2A, Appendix D)

The following clauses will be included in deeds, licenses, permits, or similar instruments/ agreements entered into by the North Carolina Department of Transportation (NCDOT) pursuant to the provisions of Assurance 7(b):

1. The (grantee, licensee, permittee, etc., as appropriate) for himself/herself, his/her heirs, personal representatives, successors in interest, and assigns, as a part of the consideration hereof, does hereby covenant and agree (in the case of deeds and leases add, "as a covenant running with the land") that (1) no person on the ground of race, color, or national origin, will be excluded from participation in, denied the benefits of, or be otherwise subjected to discrimination in the use of said facilities, (2) that in the construction of any improvements on, over, or under such land, and the furnishing of services thereon, no person on the ground of race, color, or national origin, will be excluded from participation in, denied the benefits of, or otherwise be subjected to discrimination, (3) that the (grantee, licensee, lessee, permittee, etc.) will use the premises in compliance with all other requirements imposed by or pursuant to the Acts and Regulations, as amended, set forth in this Assurance.
2. With respect to (licenses, leases, permits, etc.), in the event of breach of any of the above Non-discrimination covenants, the NCDOT will have the right to terminate the (license, permit, etc., as appropriate) and to enter or re-enter and repossess said land and the facilities thereon, and hold the same as if said (license, permit, etc., as appropriate) had never been made or issued. *
3. With respect to deeds, in the event of breach of any of the above Nondiscrimination covenants, the NCDOT will there upon revert to and vest in and become the absolute property of the NCDOT and its assigns. *

(*Reverter clause and related language to be used only when it is determined that such a clause is necessary to make clear the purpose of Title VI.)

STANDARD SPECIAL PROVISION**ON-THE-JOB TRAINING**

(10-16-07) (Rev. 4-21-15)

Z-10

Description

The North Carolina Department of Transportation will administer a custom version of the Federal On-the-Job Training (OJT) Program, commonly referred to as the Alternate OJT Program. All contractors (existing and newcomers) will be automatically placed in the Alternate Program. Standard OJT requirements typically associated with individual projects will no longer be applied at the project level. Instead, these requirements will be applicable on an annual basis for each contractor administered by the OJT Program Manager.

On the Job Training shall meet the requirements of 23 CFR 230.107 (b), 23 USC – Section 140, this provision and the On-the-Job Training Program Manual.

The Alternate OJT Program will allow a contractor to train employees on Federal, State and privately funded projects located in North Carolina. However, priority shall be given to training employees on NCDOT Federal-Aid funded projects.

Minorities and Women

Developing, training and upgrading of minorities and women toward journeyman level status is a primary objective of this special training provision. Accordingly, the Contractor shall make every effort to enroll minority and women as trainees to the extent that such persons are available within a reasonable area of recruitment. This training commitment is not intended, and shall not be used, to discriminate against any applicant for training, whether a member of a minority group or not.

Assigning Training Goals

The Department, through the OJT Program Manager, will assign training goals for a calendar year based on the contractors' past three years' activity and the contractors' anticipated upcoming year's activity with the Department. At the beginning of each year, all contractors eligible will be contacted by the Department to determine the number of trainees that will be assigned for the upcoming calendar year. At that time the Contractor shall enter into an agreement with the Department to provide a self-imposed on-the-job training program for the calendar year. This agreement will include a specific number of annual training goals agreed to by both parties. The number of training assignments may range from 1 to 15 per contractor per calendar year. The Contractor shall sign an agreement to fulfill their annual goal for the year.\

Training Classifications

The Contractor shall provide on-the-job training aimed at developing full journeyman level workers in the construction craft/operator positions. Preference shall be given to providing training in the following skilled work classifications:

Equipment Operators	Office Engineers
Truck Drivers	Estimators
Carpenters	Iron / Reinforcing Steel Workers
Concrete Finishers	Mechanics
Pipe Layers	Welders

The Department has established common training classifications and their respective training requirements that may be used by the contractors. However, the classifications established are not all-inclusive. Where the training is oriented toward construction applications, training will be allowed in lower-level management positions such as office engineers and estimators. Contractors shall submit new classifications for specific job functions that their employees are performing. The Department will review and recommend for acceptance to FHWA the new classifications proposed by contractors, if applicable. New classifications shall meet the following requirements:

Proposed training classifications are reasonable and realistic based on the job skill classification needs, and

The number of training hours specified in the training classification is consistent with common practices and provides enough time for the trainee to obtain journeyman level status.

The Contractor may allow trainees to be trained by a subcontractor provided that the Contractor retains primary responsibility for meeting the training and this provision is made applicable to the subcontract. However, only the Contractor will receive credit towards the annual goal for the trainee.

Where feasible, 25 percent of apprentices or trainees in each occupation shall be in their first year of apprenticeship or training. The number of trainees shall be distributed among the work classifications on the basis of the contractor's needs and the availability of journeymen in the various classifications within a reasonable area of recruitment.

No employee shall be employed as a trainee in any classification in which they have successfully completed a training course leading to journeyman level status or in which they have been employed as a journeyman.

Records and Reports

The Contractor shall maintain enrollment, monthly and completion reports documenting company compliance under these contract documents. These documents and any other information as requested shall be submitted to the OJT Program Manager.

Upon completion and graduation of the program, the Contractor shall provide each trainee with a certification Certificate showing the type and length of training satisfactorily completed.

Trainee Interviews

All trainees enrolled in the program will receive an initial and Trainee/Post graduate interview conducted by the OJT program staff.

Trainee Wages

Contractors shall compensate trainees on a graduating pay scale based upon a percentage of the prevailing minimum journeyman wages (Davis-Bacon Act). Minimum pay shall be as follows:

60 percent	of the journeyman wage for the first half of the training period
75 percent	of the journeyman wage for the third quarter of the training period
90 percent	of the journeyman wage for the last quarter of the training period

In no instance shall a trainee be paid less than the local minimum wage. The Contractor shall adhere to the minimum hourly wage rate that will satisfy both the NC Department of Labor (NCDOL) and the Department.

Achieving or Failing to Meet Training Goals

The Contractor will be credited for each trainee employed by him on the contract work who is currently enrolled or becomes enrolled in an approved program and who receives training for at least 50 percent of the specific program requirement. Trainees will be allowed to be transferred between projects if required by the Contractor's scheduled workload to meet training goals.

If a contractor fails to attain their training assignments for the calendar year, they may be taken off the NCDOT's Bidders List.

Measurement and Payment

No compensation will be made for providing required training in accordance with these contract documents.

U-2714

GT-1.1

Wayne County

STANDARD SHORING:**(1-16-18)****Description**

Standard shoring includes standard temporary shoring and standard temporary mechanically stabilized earth (MSE) walls. At the Contractor's option, use standard shoring as noted in the plans or as directed. When using standard shoring, a temporary shoring design submittal is not required. Construct standard shoring based on actual elevations and shoring dimensions in accordance with the contract and Geotechnical Standard Detail No. 1801.01 or 1801.02.

Define "standard temporary shoring" as cantilever shoring that meets the standard temporary shoring detail (Geotechnical Standard Detail No. 1801.01). Define "standard temporary wall" as a temporary MSE wall with geotextile or geogrid reinforcement that meets the standard temporary wall detail (Geotechnical Standard Detail No. 1801.02). Define "standard temporary geotextile wall" as a standard temporary wall with geotextile reinforcement and "standard temporary geogrid wall" as a standard temporary wall with geogrid reinforcement.

Provide positive protection for standard shoring at locations shown in the plans and as directed. See *Temporary Shoring* provision for positive protection types and definitions.

Materials

Refer to the *Standard Specifications*.

Item	Section
Concrete Barrier Materials	1170-2
Flowable Fill, Excavatable	1000-6
Geosynthetics	1056
Neat Cement Grout, Type 1	1003
Portland Cement Concrete, Class A	1000
Select Materials	1016
Steel Beam Guardrail Materials	862-2
Steel Sheet Piles and H-Piles	1084
Untreated Timber	1082-2
Welded Wire Reinforcement	1070-3

Provide Type 6 material certifications for shoring materials. Use Class IV select material for temporary guardrail. Use Class A concrete that meets Article 450-2 of the *Standard Specifications* or grout for drilled-in piles.

Based on actual shoring height, positive protection, groundwater elevation, slope or surcharge case and traffic impact at each standard temporary shoring location, use sheet piles with the minimum required section modulus or H-piles with the sizes shown in Geotechnical Standard Detail No. 1801.01. Use untreated timber with a thickness of at least 3" and a bending stress of at least 1,000 psi for timber lagging.

(A) Shoring Backfill

Use Class II, Type 1, Class III, Class V or Class VI select material or material that meets AASHTO M 145 for soil classification A-2-4 with a maximum PI of 6 for shoring backfill except do not use the following:

- (1) A-2-4 soil for backfill around culverts,

U-2714

GT-1.2

Wayne County

- (2) A-2-4 soil in the reinforced zone of standard temporary walls with a back slope and
- (3) Class VI select material in the reinforced zone of standard temporary geotextile walls.

(B) Standard Temporary Walls

Use welded wire reinforcement for welded wire facing, struts and wires with the dimensions and minimum wire sizes shown in Geotechnical Standard Detail No. 1801.02. Provide Type 2 geotextile for separation and retention geotextiles. Do not use more than 4 different reinforcement strengths for each standard temporary wall.

(1) Geotextile Reinforcement

Provide Type 5 geotextile for geotextile reinforcement with a mass per unit area of at least 8 oz/sy in accordance with ASTM D5261. Based on actual wall height, groundwater elevation, slope or surcharge case and shoring backfill to be used in the reinforced zone at each standard temporary geotextile wall location, provide geotextiles with ultimate tensile strengths as shown in Geotechnical Standard Detail No. 1801.02.

(2) Geogrid Reinforcement

Use geogrids with a roll width of at least 4 ft and an “approved” or “approved for provisional use” status code. The list of approved geogrids is available from: connect.ncdot.gov/resources/Materials/Pages/Materials-Manual-by-Material.aspx

Based on actual wall height, groundwater elevation, slope or surcharge case and shoring backfill to be used in the reinforced zone at each standard temporary geogrid wall location, provide geogrids for geogrid reinforcement with short-term design strengths as shown in Geotechnical Standard Detail No. 1801.02. Geogrids are typically approved for ultimate tensile strengths in the machine direction (MD) and cross-machine direction (CD) or short-term design strengths for a 3-year design life in the MD based on material type. Define material type from the website above for shoring backfill as follows:

Material Type	Shoring Backfill
Borrow	A-2-4 Soil
Fine Aggregate	Class II, Type 1 or Class III Select Material
Coarse Aggregate	Class V or VI Select Material

If the website does not list a short-term design strength for an approved geogrid, use a short-term design strength equal to the ultimate tensile strength divided by 3.5 for the geogrid reinforcement.

Preconstruction Requirements**(A) Concrete Barrier**

Define “clear distance” behind concrete barrier as the horizontal distance between the barrier and edge of pavement. The minimum required clear distance for concrete barrier is shown in the plans. At the Contractor’s option or if the minimum required clear distance is not available, set concrete barrier next to and up against traffic side of standard shoring

except for barrier above standard temporary walls. Concrete barrier with the minimum required clear distance is required above standard temporary walls.

(B) Temporary Guardrail

Define “clear distance” behind temporary guardrail as the horizontal distance between guardrail posts and standard shoring. At the Contractor’s option or if clear distance for standard temporary shoring is less than 4 ft, attach guardrail to traffic side of shoring as shown in the plans. Place ABC in clear distance and around guardrail posts instead of pavement. Do not use temporary guardrail above standard temporary walls.

(C) Standard Shoring Selection Forms

Before beginning standard shoring construction, survey existing ground elevations in the vicinity of standard shoring locations to determine actual shoring or wall heights (H). Submit a standard shoring selection form for each location at least 7 days before starting standard shoring construction. Standard shoring selection forms are available from:

connect.ncdot.gov/resources/Geological/Pages/Geotech_Forms_Details.aspx

Construction Methods

Construct standard shoring in accordance with the *Temporary Shoring* provision.

(A) Standard Temporary Shoring Installation

Based on actual shoring height, positive protection, groundwater elevation, slope or surcharge case and traffic impact at each standard temporary shoring location, install piles with the minimum required embedment and extension for each shoring section in accordance with Geotechnical Standard Detail No. 1801.01. For concrete barrier above and next to standard temporary shoring and temporary guardrail above and attached to standard temporary shoring, use “surcharge case with traffic impact” in accordance with Geotechnical Standard Detail No. 1801.01. Otherwise, use “slope or surcharge case with no traffic impact” in accordance with Geotechnical Standard Detail No. 1801.01. If refusal is reached before driven piles attain the minimum required embedment, use drilled-in H-piles with timber lagging for standard temporary shoring.

(B) Standard Temporary Walls Installation

Based on actual wall height, groundwater elevation, slope or surcharge case, geotextile or geogrid reinforcement and shoring backfill in the reinforced zone at each standard temporary wall location, construct walls with the minimum required reinforcement length and number of reinforcement layers for each wall section in accordance with Geotechnical Standard Detail No. 1801.02. For standard temporary walls with pile foundations in the reinforced zone, drive piles through reinforcement after constructing temporary walls.

For standard temporary walls with interior angles less than 90°, wrap geosynthetics at acute corners as directed by the Engineer. Place geosynthetics as shown in Geotechnical Standard Detail No. 1801.02. Place separation geotextiles between shoring backfill and backfill, natural ground or culverts along the sides of the reinforced zone perpendicular to the wall face. For Class V or VI select material in the reinforced zone, place separation geotextiles between shoring backfill and backfill or natural ground on top of and at the back of the reinforced zone.

U-2714

GT-1.4

Wayne County

Measurement and Payment

Standard shoring will be measured and paid in accordance with the *Temporary Shoring* provision.



2/12/2020

**PROJECT SPECIAL PROVISIONS
GEOENVIRONMENTAL**

CONTAMINATED SOIL (9/27/2019)

The Contractor's attention is directed to the fact that soil contaminated with petroleum hydrocarbon compounds exist within the project area. The known areas of contamination are indicated on corresponding plans sheets. Information relating to these contaminated areas, sample locations, and investigation reports will be available at the following web address by navigating to the correct letting year and month then selecting, "Plans and Proposals", "Wayne U-2714", "GeoEnv Postings":

<http://dotw-xfer01.dot.state.nc.us/dsplan/>

Petroleum contaminated soil may be encountered during any earthwork activities on the project. The Contractor shall only excavate those soils that the Engineer designates necessary to complete a particular task. The Engineer shall determine if soil is contaminated based on areas shown on the plans, petroleum odors, and unusual soil staining. Contaminated soil not required to be excavated is to remain in place and undisturbed. Undisturbed soil shall remain in place, whether contaminated or not. The Contractor shall transport all contaminated soil excavated from the project to a facility licensed to accept contaminated soil.

In the event that a stockpile is needed, the stockpile shall be created within the property boundaries of the source material and in accordance with the Diagram for Temporary Containment and Treatment of Petroleum-Contaminated Soil per North Carolina Department of Environmental Quality's (NCDEQ) Division of Waste Management UST Section GUIDELINES FOR EX SITU PETROLEUM CONTAMINATED SOIL REMEDIATION. If the volume of contaminated material exceeds available space on site, the Contractor shall obtain a permit from the NCDEQ UST Section's Regional Office for off-site temporary storage. The Contractor shall provide copies of disposal manifests completed per the disposal facilities requirements and weigh tickets to the Engineer.

If groundwater is encountered and dewatering is required in areas of known contamination, then the contractor shall containerize the groundwater in vessels provided by the Department. The Department will be responsible for the sampling and disposal of the water. Handling contaminated ground water will be incidental to the project.

Measurement and Payment:

The quantity of contaminated soil hauled and disposed of shall be the actual number of tons of material, which has been acceptably transported and weighed with certified scales as documented by disposal manifests and weigh tickets. The quantity of contaminated soil, measured as provided above, shall be paid for at the contract unit price per ton for "Hauling and Disposal of Petroleum Contaminated Soil".

The above price and payment shall be full compensation for all work covered by this section, including, but not limited to stockpiling, loading, transportation, weighing, laboratory testing, disposal, equipment, decontamination of equipment, labor, and personal protective equipment.

U-2714

GV-2

Wayne County

Payment shall be made under:

Pay Item

Hauling and Disposal of Petroleum Contaminated Soil

Pay Unit

Ton

DocuSigned by:
Cyrus Parker
C96492AF5E824DF...
9/27/2019





DocuSigned by:

Matthew V. Springer

BC60F6E8B584403...
7/24/2019**NON-CAST IRON SNOWPLOWABLE PAVEMENT MARKERS:**

(07-23-19)

DESCRIPTION

Furnish, install, and maintain non-cast iron snowplowable pavement markers in accordance with the contract.

MATERIALS

Revise the *2018 Standard Specifications* as follows:

Pages 10-177 and 10-178, Subarticle 1086-3 SNOWPLOWABLE PAVEMENT MARKERS, delete items (A), (B) and (C)(1) and replace with the following:

(A) General

Use non-cast iron snowplowable pavement markers evaluated by NTPEP. The non-cast iron snowplowable pavement marker shall consist of a housing with one or more glass or plastic face lens type reflective lenses to provide the required color designation. The marker shall be designed or installed in a manner that minimizes damage from snowplow blades. Plastic lens faces shall use an abrasion resistant coating.

(B) Housings**(1) Dimensions**

The dimension, slope and minimum area of reflecting surface shall conform to dimensions as shown in the plans. The minimum area of each reflecting surface shall be 1.44 sq.in.

(2) Materials

Use non-cast iron snowplowable pavement markers that are on the NCDOT Approved Products List.

(3) Surface

The surface of the housing shall be free of scale, dirt, rust, oil, grease or any other contaminant which might reduce its bond to the epoxy adhesive.

(4) Identification

Mark the housing with the manufacturer's name and model number of marker.

(C) Reflectors

(1) General

Laminate the reflector to an elastomeric pad and attach with adhesive to the housing. The thickness of the elastomeric pad shall be 0.04".

Pages 12-14, Subarticle 1250-3(C) Removal of Existing Pavement Markers, lines 19-29, delete and replace with the following:

Remove the existing raised pavement markers or the snowplowable pavement markers including the housings, before overlaying an existing roadway with pavement. Repair the pavement by filling holes as directed by the Engineer.

When traffic patterns are changed in work zones due to construction or reconstruction, remove all raised pavement markers or snowplowable markers including housings that conflict with the new traffic pattern before switching traffic to the new traffic pattern. Lens removal in lieu of total housing removal is not an acceptable practice for snowplowable markers.

Properly dispose of the removed pavement markers. No direct payment will be made for removal or disposal of existing pavement markers or repair of pavement, as such work will be incidental to other items in the contract.

CONSTRUCTION METHODS

Pages 12-16 and 12-17, Subarticle 1253-3 CONSTRUCTION METHODS, delete items (A), (B) and (C) and replace with the following:

(A) General

Bond marker housings to the pavement with epoxy adhesive. Mechanically mix and dispense epoxy adhesives as required by the manufacturer's specifications. Place the markers immediately after the adhesive has been mixed and dispensed.

If saw cutting, milling, or grooving operations are used, promptly remove all resulting debris from the pavement surface. Install the marker housings within 7 calendar days after saw cutting, milling, or grooving the pavement. Remove and dispose of loose material from the slots by brushing, blow cleaning, or vacuuming. Dry the slots before applying the epoxy adhesive. Install non-cast iron snowplowable pavement markers according to the manufacturer's recommendations.

Protect the non-cast iron snowplowable pavement markers until the epoxy has initially cured and is track free.

(B) Reflector Replacement

In the event that a reflector is damaged, replace the damaged reflector by using adhesives and methods recommended by the manufacturer of the markers and approved by the Engineer. This work is considered incidental if damage occurs during the initial installation of the marker housings and maintenance of initial non-cast iron snowplowable markers specified in this section. This work will be paid for under the pay item for the type of reflector replacement if the damage occurred after the initial installation of the non-cast iron snowplowable pavement marker.

Missing housings shall be replaced. Broken housings shall be removed and replaced. In both cases the slot for the housings shall be properly prepared prior to installing the new housing. Removal of broken housings and preparation of slots will be considered incidental to the work of replacing housings.

MAINTENANCE

Maintain all installed non-cast iron snowplowable pavement markers until acceptance.

MEASUREMENT AND PAYMENT

Non-Cast Iron Snowplowable Pavement Markers will be measured and paid as the actual number of non-cast iron snowplowable pavement markers satisfactorily placed and accepted by the Engineer.

Payment will be made under:

Pay Item	Pay Unit
Non-Cast Iron Snowplowable Pavement Marker	Each

TC-1

U-2714

Wayne County

WORK ZONE TRAFFIC CONTROL Project Special Provisions Table of Contents

Special Provision	Page
ADA Compliant Pedestrian Traffic Control Devices	TC-2



Michelle Ward

1/23/2020

TC-2

U-2714

Wayne County

ADA COMPLIANT PEDESTRIAN TRAFFIC CONTROL DEVICES:
(10/31/2017)

Description

Furnish, install, and maintain all ADA compliant pedestrian traffic control devices for existing sidewalks that are disrupted, closed, or relocated by planned work activities.

The ADA compliant pedestrian traffic control devices used to either close, redirect, divert or detour pedestrian traffic are Pedestrian Channelizing Devices, Audible Warning Devices and Temporary Curb Ramps. Pedestrian Channelizing Devices are the only pedestrian traffic control device required on this project.

Construction Methods

The ADA compliant pedestrian traffic control devices involved in the closing or redirecting of pedestrians as designated on the Transportation Management Plan (TMP) shall be manufactured and assembled in accordance with the requirements of the Americans with Disabilities Act (ADA) and be on the NCDOT approved products list.

Pedestrian Channelizing Devices shall be manufactured and assembled to be connected as to eliminate any gaps that allow pedestrians to stray from the channelizing path. Any Pedestrian Channelizing Devices used to close or block a sidewalk shall have a "SIDEWALK CLOSED" sign affixed to it and any audible warning devices, if designated on the TMP.

Measurement and Payment

The measurement and payment for the Pedestrian Channelizing Devices will be by the linear foot.

Payment for this device is dependent upon satisfactory installation and acceptance by the Engineer. The unit price includes any costs associated with installation, maintenance and removal of the device from the project.

Payment will be made under:

Pay Item	Pay Unit
Pedestrian Channelizing Devices.....	Linear Foot

Project: U-2714

UC-1

County: Wayne



PROJECT SPECIAL PROVISIONS
Utility Construction

Revise the 2018 Standard Specifications as follows:

Page 10-63, Sub-article 1036-6 FIRE HYDRANTS:

add the following sentences:

Fire Hydrants: Fire hydrants shall be Mueller Centurion or approved equal. Fire hydrants shall be 4½-inch traffic model, compression type, cast iron, and shall conform to the requirements of AWWA C502, latest edition. Fire hydrants shall have a 6-inch mechanical joint shoe inlet with a minimum 4½-inch main valve. Each hydrant shall have two 2½-inch hose nozzles and one 4½-inch pumper nozzle with caps and washer chains attached to the hydrant barrel. Barrel lengths shall be generally for 3½-foot trenches, except where other lengths are necessitated by the hydrant location. Hydrants shall open with a counterclockwise rotation of the nut. The hydrant stem shall be non-rising. Operating and cap nuts shall be pentagon shaped, 1½ inches from point to flat. Pumper nozzle and small nozzle threading shall be the City of Goldsboro standard as follows:

Pumper Nozzle:	Mueller Code 4-550 or equal
	Major Diameter O.D. 6.162 inches
	Pitch Diameter 6.000 inches
	Minor Diameter 5.812 inches
	4 threads per inch
	Pumper nozzle cap must also be threaded to fit.

Small nozzles are National Standard Threads.

The hydrant barrel shall be made in two sections joined together a few inches above the ground line by a watertight coupling, or break ring, so designed that if a break occurs, it will occur at this point. The ring shall be of ample strength for ordinary service, and be easily and cheaply replaceable. The valve stem shall be in two sections, jointed by a special coupling at the same point as the break ring, so designed that if the hydrant is broken, the coupling will break and the

Project: U-2714

UC-2

County: Wayne

valve will not be disturbed. All working parts shall be removable without disconnecting the hydrant.

The color of fire hydrants shall be red.

Page 10-63, Sub-article 1036-7 WATER VALVES:

add the following sentences:

Gate valves shall be Mueller Resilient Seat gate valves or approved equal and conform to AWWA C509. Valves shall have ends adapted to the type of pipe or fittings to be installed. Valves shall be iron body, fully bronze mounted, modified wedge disc patten, O-ring seals, and designed for 150 psi working pressure. Valves shall have a breaking point in the stem that allows the stem to shear off near the operating nut so that the valve can still be controlled if the stem is sheared. Valves shall have non-rising stems and shall open counterclockwise with a 2-inch square operating nut. Gate valves 16 inches in diameter and larger for vertical installation shall be equipped with a bypass valve assembly, spur gearing with grease case, and a shoe on each side of the disc assembly for guiding the disc assembly throughout its entire travel. Gate valves 16 inches in diameter and larger for horizontal installation shall be equipped with a bypass valve assembly, bevel gearing with grease case, and rollers and scrapers on tracks.

Valve Boxes: Valve boxes shall be gray iron meeting the requirements of ASTM A48 for Class 30 iron. Valve boxes shall be Dewey Bros. #VBX-TI-100, or approved equal.

Page 10-64, Sub-article 1036-9 SERVICE LINE VALVES AND FITTINGS:

add the following sentences:

Corporation and Meter Stops: Corporation and meter stops shall be AWWA approved. Corporation stops shall have AWWA threads on the inlet and a connection for copper pipe on the outlet. Meter stops shall have a compression connection for CTS O.D. tubing one end and inside I.P. thread other end. Meter stops shall be Mueller H-14258, Ford KV43, or approved equal.

Service Saddles: Service saddles shall be double strap, nylon coated iron service saddle with wide stainless steel straps. Service saddles shall be Smith-Blair 317, ROMAC 202N, or approved equal.

Page 10-121, Sub-article 1077-3 PRECAST CONCRETE UNIT MATERIALS:

add the following sentences:

Precast Concrete Manholes: Precast concrete manholes shall be concentric type with monolithic base conforming to ASTM C-478. Manholes shall conform to the dimensions shown on the plans. Manhole joint material shall be O-ring gaskets conforming to ASTM C-443. In lieu of O-ring gaskets, approved flexible plastic gaskets meeting the requirements of Federal Specification SS-S-00210 may be used. Plastic gaskets shall be produced from blends of refined hydrocarbon resins and plasticizing compounds reinforced with inert mineral filler and shall contain no solvents. The gasket sealer shall not depend on oxidizing, evaporating, or chemical action for its adhesive or

Project: U-2714

UC-3

County: Wayne

cohesive strength. It shall be supplied in extruded rope form or flat tape form of suitable cross-section and of such size as to fill the joint space completely according to the manufacturer's recommendations. Prior to the joint installation, joint surfaces shall be painted with a bituminous primer as recommended by the manufacturer of the joint material. Manhole steps shall be set 16 inches on centers and shall conform to ASTM A-48 Class 30 and be of the design and dimensions shown on the plans.

Precast concrete manholes shall be constructed to the dimensions shown on the plans. The Contractor may use precast concrete manholes in lieu of masonry manholes unless otherwise shown on the plans or stated in the Special Conditions.

Prior to installation, precast concrete manholes shall be cleaned and inspected to insure that they are sound and free from defects. In the event that a manhole is found defective or damaged, the Engineer shall be informed. Repairs to defective or damaged manholes may be made subject to the approval of the Engineer and in accordance with his instructions.

The openings in the manholes shall be made by the manufacturer and shall be 4 inches larger in diameter than the outside diameter of the pipe barrel for which the opening is made. The cutting of pipe holes by means of hammer, chisel, or similar equipment is prohibited. Joints between the pipe and the manhole wall shall be made watertight by using cement grout. Prior to grouting, the pipe and manhole wall shall be cleaned to remove deleterious material that would prevent proper bond. All holes used to facilitate lifting and placing the manhole sections shall be completely sealed with cement grout.

Precast concrete manhole joints shall be made water tight by using O-ring gaskets or flexible plastic gasket material as specified above in paragraph 7-2. Prior to the installation of gasket materials, the tongue and groove of the joint shall be cleaned and then primed or lubricated in accordance with the gasket manufacturer's recommendation.

Precast manholes shall be centered over the pipes. The cone section shall be stopped 8 inches below finished grade. Manholes shall then be brought to finished grade by using two 4-inch extension rings. Extension rings shall be as manufactured by the manhole manufacturer. Manhole rings and covers shall be set in full mortar beds to the grade established by the Engineer.

The inverts of precast concrete manholes shall be constructed in accordance with the requirements for masonry manhole inverts given above.

Page 15-1, Sub-article 1500-2 COOPERATION WITH UTILITY OWNERS, paragraph 2:
add the following sentences:

The utility owners are the City of Goldsboro and the Town of Fremont. The contact person for the City of Goldsboro is Mr. Marty Anderson, PE and Mr. Michael McAllister for the Town of Fremont. Mr. Anderson can be reached by phone at (919) 580-4377 and Mr. McAllister can be reached by phone at (919) 772-5393.

Project: U-2714

UC-4

County: Wayne

All proposed water and sewer line relocation work shall be performed at a time to be coordinated with the utility owner. Water and sewer lines shall not be taken out of service without prior approval of the utility owner and service interruptions shall not exceed four hours.

Page 15-2, Sub-article 1500-7 SUBMITTALS AND RECORDS, paragraph 3: add the following sentences:

As-built plans shall be provided to the City of Goldsboro and the Town of Fremont showing the size and type of material installed and the coordinates of all utility horizontal and vertical locations of installed piping and appurtenances. As-built plans and associated documentation shall be provided to the Engineer prior to acceptance of the work.

Page 15-6, Sub-Article 1510-2, Materials, delete the sentence for marking tape line 1 and 2 and add the following sentence:

Marking tape shall be installed continuously and longitudinally along all water mains and water services installed by open trench methods. The marking tape shall be installed directly above the center of the pipe and at least 16" deep from final grade to a maximum depth of 24" below final grade. The marking tape shall be made of polyethylene (or approved equivalent) material, 6" wide and a minimum of 6 mm thick. The tape shall be blue in color and shall be marked with the words "CAUTION WATER LINE BURIED BELOW" (or an approved equivalent wording). The wording shall be repetitive along the full length of tape.

Page 15-8, Sub-Article 1515-3 (D), FIRE HYDRANT, add the following sentence at the end of line 24:

The new fire hydrants shall be installed and operational prior to taking the old fire hydrants out of service.

Project: U-2714

UC-5

County: Wayne

REMOVE BACKFLOW PREVENTION ASSEMBLY

General:

This work consists of the removing the existing backflow prevention assemblies as shown on the plans or as directed by the Engineer. The backflow prevention assembly shall be removed and either returned to the City of Goldsboro or it becomes the property of the contractor to dispose of.

Measurement and Payment:

Measurement and payment will be made on a per each basis for each remove backflow prevention assembly on this project. No additional payment will be made for any miscellaneous items necessary to remove backflow prevention assembly.

Pay Item	Pay Unit
Remove Backflow Prevention Assembly	Each

FLEXIBLE COUPLING

General:

Flexible couplings shall be installed in accordance with the applicable utility provisions herein, as shown on the utility plans, and/or as directed by the Engineer.

Install elastomeric couplings to join plain ends of gravity sanitary sewer pipe when transitioning from DI pipe to Clay pipe.

Couplings shall be elastomeric PVC sleeve couplings with stainless steel compression bands and stainless-steel shear rings. The couplings shall provide a watertight connection.

Measurement and Payment:

Measurement and payment will be made on a per each basis for each flexible coupling installed. No additional payment will be made for other appurtenances or miscellaneous items necessary to install the flexible coupling.

Pay Item	Pay Unit
8" Flexible Coupling	Each

Project: U-2714

UC-6

County: Wayne

REMOVE AND STOCKPILE EXISTING FIRE HYDRANT:

General:

The existing fire hydrants to be removed and stockpiled will be separated at the hydrant base from the existing pipe. The contractor shall deliver the existing fire hydrants removed to the City of Goldsboro.

The contractor shall stockpile the existing fire hydrants removed at a designated area on the job site for delivery to City of Goldsboro or deliver each existing fire hydrant removed directly to the City of Goldsboro.

Measurement and Payment:

Measurement and payment will be made on a per each basis for each existing fire hydrant removed and stockpile. No additional payment will be made for any miscellaneous items necessary to remove and stockpile the existing fire hydrant.

Pay Item	Pay Unit
Remove and Stockpile Existing Fire Hydrant	Each

END OF SECTION

PROJECT SPECIAL PROVISIONS

Utilities by Others

**General:**

The following utility companies have facilities that will be in conflict with the construction of this project:

- A) Duke Energy Progress
- B) Piedmont Natural Gas
- C) City of Goldsboro
- D) NCDOT (Traffic Signal Fiber)
- E) Spectrum/Charter
- F) AT&T

The conflicting facilities of these concerns will be adjusted prior to the date of availability, unless otherwise noted and are therefore listed in these special provisions for the benefit of the Contractor. All utility work listed herein will be done by the utility owners. All utilities are shown on the plans from the best available information.

The Contractor's attention is directed to Article 105-8 of the 2018 Standard Specifications.

Utilities Requiring Adjustment:

Utility relocations are shown on the Utilities by Others Plans.

A) Duke Energy Progress:

- 1) Duke Energy Progress will relocate their overhead and underground facilities prior to March 19th, 2020.
- 2) Contact person for Duke Energy Progress is Mr. David Icenhour at 919-703-2553 and David.Icenhour@duke-energy.com.

B) Piedmont Natural Gas:

- 1) Piedmont Natural Gas will relocate their underground facilities prior to March 19th, 2020.
- 2) Contact person for Piedmont Natural Gas is Ms. Linda Scharf-Byers at 919-705-5042 and Linda.Scharf-Byers@duke-energy.com.

PROJECT SPECIAL PROVISIONS

Utilities by Others

C) City of Goldsboro:

- 1) City of Goldsboro will relocate their overhead and underground facilities prior to March 19th, 2020.
- 2) Contact person for City of Goldsboro is Mr. Marty Anderson at 919-580-4377 and MAnderson@goldsboronc.gov.

D) NCDOT (Traffic Signal Fiber):

- 1) NCDOT will relocate their overhead and underground facilities prior to March 19th, 2020.
- 2) Contact person for NCDOT is Mr. Paul Marak at 252-640-6502 and pmarak@ncdot.gov.

E) Spectrum/Charter:

- 1) Spectrum/Charter will relocate their overhead and underground facilities prior to January 15th, 2021. **Spectrum will relocate their service working South to North.**
- 2) Contact person for Spectrum/Charter is Mr. Chris Mingle at 919-903-0160 and Chris.Mingle@charter.com.

F) AT&T:

- 1) AT&T will relocate their overhead and underground facilities prior to January 15th, 2021. **AT&T will relocate their service working South to North.**
- 2) Contact person for AT&T is Mr. Doc Potter at 919-788-2758 and Dp5228@att.com.

The Contractor is advised to contact AT&T when working in the area near the installation of the 42" RCP-IV on the left side of the -L- alignment at Stations 74+00 to 75+00. AT&T has constructed temporary overhead facilities between Stations 73+60 and 76+50. The existing duct bank will be abandoned by AT&T within this location. AT&T can be contacted to send a representative to confirm prior to removal or destruction of the existing duct bank by the Contractor. The Contractor should be aware of the transition between underground and overhead at this location.

AT&T has completed all underground work between Station 11+50 to 20+75.

**Project Special Provisions
Erosion Control**

STABILIZATION REQUIREMENTS:

(4-30-2019)

Stabilization for this project shall comply with the time frame guidelines as specified by the NCG-010000 general construction permit effective April 1, 2019 issued by the North Carolina Department of Environmental Quality Division of Water Resources. Temporary or permanent ground cover stabilization shall occur within 7 calendar days from the last land-disturbing activity, with the following exceptions in which temporary or permanent ground cover shall be provided in 14 calendar days from the last land-disturbing activity:

- Slopes between 2:1 and 3:1, with a slope length of 10 ft. or less
- Slopes 3:1 or flatter, with a slope of length of 50 ft. or less
- Slopes 4:1 or flatter

The stabilization timeframe for High Quality Water (HQW) Zones shall be 7 calendar days with no exceptions for slope grades or lengths. High Quality Water Zones (HQW) Zones are defined by North Carolina Administrative Code 15A NCAC 04A.0105 (25). Temporary and permanent ground cover stabilization shall be achieved in accordance with the provisions in this contract and as directed.

SEEDING AND MULCHING:

(East)

The kinds of seed and fertilizer, and the rates of application of seed, fertilizer, and limestone, shall be as stated below. During periods of overlapping dates, the kind of seed to be used shall be determined. All rates are in pounds per acre.

All Roadway Areas

March 1 - August 31		September 1 - February 28	
50#	Tall Fescue	50#	Tall Fescue
10#	Centipede	10#	Centipede
25#	Bermudagrass (hulled)	35#	Bermudagrass (unhulled)
500#	Fertilizer	500#	Fertilizer
4000#	Limestone	4000#	Limestone

Waste and Borrow Locations

March 1 – August 31		September 1 - February 28	
75#	Tall Fescue	75#	Tall Fescue
25#	Bermudagrass (hulled)	35#	Bermudagrass (unhulled)
500#	Fertilizer	500#	Fertilizer
4000#	Limestone	4000#	Limestone

Note: 50# of Bahiagrass may be substituted for either Centipede or Bermudagrass only upon Engineer's request.

Approved Tall Fescue Cultivars

06 Dust	Escalade	Justice	Serengeti
2 nd Millennium	Essential	Kalahari	Shelby
3 rd Millennium	Evergreen 2	Kitty Hawk 2000	Sheridan
Apache III	Falcon IV	Legitimate	Signia
Avenger	Falcon NG	Lexington	Silver Hawk
Barlexas	Falcon V	LSD	Sliverstar
Barlexas II	Faith	Magellan	Shenandoah Elite
Bar Fa	Fat Cat	Matador	Sidewinder
Barrera	Festnova	Millennium SRP	Skyline
Barrington	Fidelity	Monet	Solara
Barrobusto	Finelawn Elite	Mustang 4	Southern Choice II
Barvado	Finelawn Xpress	Ninja 2	Speedway
Biltmore	Finesse II	Ol' Glory	Spyder LS
Bingo	Firebird	Olympic Gold	Sunset Gold
Bizem	Firecracker LS	Padre	Taccoa
Blackwatch	Firenza	Patagonia	Tanzania
Blade Runner II	Five Point	Pedigree	Trio
Bonsai	Focus	Picasso	Tahoe II
Braveheart	Forte	Piedmont	Talladega
Bravo	Garrison	Plantation	Tarheel
Bullseye	Gazelle II	Proseeds 5301	Terrano
Cannavaro	Gold Medallion	Prospect	Titan ltd
Catalyst	Grande 3	Pure Gold	Titanium LS
Cayenne	Greenbrooks	Quest	Tracer
Cessane Rz	Greenkeeper	Raptor II	Traverse SRP
Chipper	Gremlin	Rebel Exeda	Tulsa Time
Cochise IV	Greystone	Rebel Sentry	Turbo
Constitution	Guardian 21	Rebel IV	Turbo RZ
Corgi	Guardian 41	Regiment II	Tuxedo RZ
Corona	Hemi	Regenerate	Ultimate
Coyote	Honky Tonk	Rendition	Venture
Darlington	Hot Rod	Rhambler 2 SRP	Umbrella
Davinci	Hunter	Rembrandt	Van Gogh
Desire	Inferno	Reunion	Watchdog
Dominion	Innovator	Riverside	Wolfpack II
Dynamic	Integrity	RNP	Xtremegreen
Dynasty	Jaguar 3	Rocket	
Endeavor	Jamboree	Scorpion	

On cut and fill slopes 2:1 or steeper Centipede shall be applied at the rate of 5 pounds per acre and add 20# of Sericea Lespedeza from January 1 - December 31.

Fertilizer shall be 10-20-20 analysis. A different analysis of fertilizer may be used provided the 1-2-2 ratio is maintained and the rate of application adjusted to provide the same amount of plant food as a 10-20-20 analysis and as directed.

Native Grass Seeding and Mulching (East)

Native Grass Seeding and Mulching shall be performed on the disturbed areas of wetlands and riparian areas, and adjacent to Stream Relocation construction within a 50 foot zone on both sides of the stream or depression, measured from top of stream bank or center of depression. The stream bank of the stream relocation shall be seeded by a method that does not alter the typical cross section of the stream bank. Native Grass Seeding and Mulching shall also be performed in the permanent soil reinforcement mat section of preformed scour holes, and in other areas as directed.

The kinds of seed and fertilizer, and the rates of application of seed, fertilizer, and limestone, shall be as stated below. During periods of overlapping dates, the kind of seed to be used shall be determined. All rates are in pounds per acre.

March 1 - August 31		September 1 - February 28	
18#	Creeping Red Fescue	18#	Creeping Red Fescue
6#	Indiangrass	6#	Indiangrass
8#	Little Bluestem	8#	Little Bluestem
4#	Switchgrass	4#	Switchgrass
25#	Browntop Millet	35#	Rye Grain
500#	Fertilizer	500#	Fertilizer
4000#	Limestone	4000#	Limestone

Approved Creeping Red Fescue Cultivars:

- Aberdeen Boreal Epic Cindy Lou

Fertilizer shall be 10-20-20 analysis. A different analysis of fertilizer may be used provided the 1-2-2 ratio is maintained and the rate of application adjusted to provide the same amount of plant food as a 10-20-20 analysis and as directed.

Native Grass Seeding and Mulching shall be performed in accordance with Section 1660 of the *Standard Specifications* and vegetative cover sufficient to restrain erosion shall be installed immediately following grade establishment.

Measurement and Payment

Native Grass *Seeding and Mulching* will be measured and paid for in accordance with Article 1660-8 of the *Standard Specifications*.

All areas seeded and mulched shall be tacked with asphalt. Crimping of straw in lieu of asphalt tack shall not be allowed on this project.

CRIMPING STRAW MULCH:

Crimping shall be required on this project adjacent to any section of roadway where traffic is to be maintained or allowed during construction. In areas within six feet of the edge of pavement, straw is to be applied and then crimped. After the crimping operation is complete, an additional application of straw shall be applied and immediately tacked with a sufficient amount of undiluted emulsified asphalt.

Straw mulch shall be of sufficient length and quality to withstand the crimping operation.

Crimping equipment including power source shall be subject to the approval of the Engineer providing that maximum spacing of crimper blades shall not exceed 8".

TEMPORARY SEEDING:

Fertilizer shall be the same analysis as specified for *Seeding and Mulching* and applied at the rate of 400 pounds and seeded at the rate of 50 pounds per acre. Sweet Sudan Grass, German Millet or Browntop Millet shall be used in summer months and Rye Grain during the remainder of the year. The Engineer will determine the exact dates for using each kind of seed.

FERTILIZER TOPDRESSING:

Fertilizer used for topdressing on all roadway areas except slopes 2:1 and steeper shall be 10-20-20 grade and shall be applied at the rate of 500 pounds per acre. A different analysis of fertilizer may be used provided the 1-2-2 ratio is maintained and the rate of application adjusted to provide the same amount of plant food as 10-20-20 analysis and as directed.

Fertilizer used for topdressing on slopes 2:1 and steeper and waste and borrow areas shall be 16-8-8 grade and shall be applied at the rate of 500 pounds per acre. A different analysis of fertilizer may be used provided the 2-1-1 ratio is maintained and the rate of application adjusted to provide the same amount of plant food as 16-8-8 analysis and as directed.

SUPPLEMENTAL SEEDING:

The kinds of seed and proportions shall be the same as specified for *Seeding and Mulching*, with the exception that no centipede seed will be used in the seed mix for supplemental seeding. The rate of application for supplemental seeding may vary from 25# to 75# per acre. The actual rate per acre will be determined prior to the time of topdressing and the Contractor will be notified in writing of the rate per acre, total quantity needed, and areas on which to apply the supplemental seed. Minimum tillage equipment, consisting of a sod seeder shall be used for incorporating seed into the soil as to prevent disturbance of existing vegetation. A clodbuster (ball and chain) may be used where degree of slope prevents the use of a sod seeder.

MOWING:

The minimum mowing height on this project shall be 4 inches.

REFORESTATION:**Description**

Reforestation will be planted within interchanges and along the outside borders of the road, and in other areas as directed. *Reforestation* is not shown on the plan sheets. See the Reforestation Detail Sheet.

All non-maintained riparian buffers impacted by the placement of temporary fill or clearing activities shall be restored to the preconstruction contours and revegetated with native woody species.

The entire *Reforestation* operation shall comply with the requirements of Section 1670 of the *Standard Specifications*.

Materials

Reforestation shall be bare root seedlings 12"-18" tall.

Construction Methods

Reforestation shall be planted as soon as practical following permanent *Seeding and Mulching*. The seedlings shall be planted in a 16-foot wide swath adjacent to mowing pattern line, or as directed.

Root dip: The roots of reforestation seedlings shall be coated with a slurry of water, and either a fine clay (kaolin) or a superabsorbent that is designated as a bare root dip. The type, mixture ratio, method of application, and the time of application shall be submitted to the Engineer for approval.

With the approval of the Engineer, seedlings may be coated before delivery to the job or at the time of planting, but at no time shall the roots of the seedlings be allowed to dry out. The roots shall be moistened immediately prior to planting.

Seasonal Limitations: *Reforestation* shall be planted from November 15 through March 15.

Measurement and Payment

Reforestation will be measured and paid for in accordance with Article 1670-17 of the *Standard Specifications*.

RESPONSE FOR EROSION CONTROL:**Description**

Furnish the labor, materials, tools and equipment necessary to move personnel, equipment, and supplies to the project necessary for the pursuit of any or all of the following work as shown herein, by an approved subcontractor.

Section	Erosion Control Item	Unit
1605	Temporary Silt Fence	LF
1606	Special Sediment Control Fence	LF/TON
1615	Temporary Mulching	ACR
1620	Seed - Temporary Seeding	LB
1620	Fertilizer - Temporary Seeding	TN
1631	Matting for Erosion Control	SY
SP	Coir Fiber Mat	SY
1640	Coir Fiber Baffles	LF
SP	Permanent Soil Reinforcement Mat	SY
1660	Seeding and Mulching	ACR
1661	Seed - Repair Seeding	LB
1661	Fertilizer - Repair Seeding	TON
1662	Seed - Supplemental Seeding	LB
1665	Fertilizer Topdressing	TON
SP	Safety/Highly Visible Fencing	LF
SP	Response for Erosion Control	EA

Construction Methods

Provide an approved subcontractor who performs an erosion control action as described in the NPDES Inspection Form SPPP30. Each erosion control action may include one or more of the above work items.

Measurement and Payment

Response for Erosion Control will be measured and paid for by counting the actual number of times the subcontractor moves onto the project, including borrow and waste sites, and satisfactorily completes an erosion control action described in Form 1675. The provisions of Article 104-5 of the *Standard Specifications* will not apply to this item of work.

Payment will be made under:

Pay Item	Pay Unit
Response for Erosion Control	Each

ENVIRONMENTALLY SENSITIVE AREAS:

Description

This project is located in an *Environmentally Sensitive Area*. This designation requires special procedures to be used for clearing and grubbing, temporary stream crossings, and grading operations within the Environmentally Sensitive Areas identified on the plans and as designated by the Engineer. This also requires special procedures to be used for seeding and mulching and staged seeding within the project.

The Environmentally Sensitive Area shall be defined as a 50-foot buffer zone on both sides of the stream or depression measured from top of streambank or center of depression.

Construction Methods

(A) Clearing and Grubbing

In areas identified as Environmentally Sensitive Areas, the Contractor may perform clearing operations, but not grubbing operations until immediately prior to beginning grading operations as described in Article 200-1 of the *Standard Specifications*. Only clearing operations (not grubbing) shall be allowed in this buffer zone until immediately prior to beginning grading operations. Erosion control devices shall be installed immediately following the clearing operation.

(B) Grading

Once grading operations begin in identified Environmentally Sensitive Areas, work shall progress in a continuous manner until complete. All construction within these areas shall progress in a continuous manner such that each phase is complete and areas are permanently stabilized prior to beginning of next phase. Failure on the part of the Contractor to complete any phase of construction in a continuous manner in Environmentally Sensitive Areas will be just cause for the Engineer to direct the suspension of work in accordance with Article 108-7 of the *Standard Specifications*.

(C) Temporary Stream Crossings

Any crossing of streams within the limits of this project shall be accomplished in accordance with the requirements of Subarticle 107-12 of the *Standard Specifications*.

(D) Seeding and Mulching

Seeding and mulching shall be performed in accordance with Section 1660 of the *Standard Specifications* and vegetative cover sufficient to restrain erosion shall be installed immediately following grade establishment.

Seeding and mulching shall be performed on the areas disturbed by construction immediately following final grade establishment. No appreciable time shall lapse into the contract time without stabilization of slopes, ditches and other areas within the Environmentally Sensitive Areas.

(E) Stage Seeding

The work covered by this section shall consist of the establishment of a vegetative cover on cut and fill slopes as grading progresses. Seeding and mulching shall be done in stages on cut and fill slopes that are greater than 20 feet in height measured along the slope, or greater than 2 acres in area. Each stage shall not exceed the limits stated above.

Additional payments will not be made for the requirements of this section, as the cost for this work shall be included in the contract unit prices for the work involved.

MINIMIZE REMOVAL OF VEGETATION:

The Contractor shall minimize removal of vegetation within project limits to the maximum extent practicable. Vegetation along stream banks and adjacent to other jurisdictional resources outside the construction limits shall only be removed upon approval of Engineer. No additional payment will be made for this minimization work.

STOCKPILE AREAS:

The Contractor shall install and maintain erosion control devices sufficient to contain sediment around any erodible material stockpile areas as directed.

ACCESS AND HAUL ROADS:

At the end of each working day, the Contractor shall install or re-establish temporary diversions or earth berms across access/haul roads to direct runoff into sediment devices. Silt fence sections that are temporarily removed shall be reinstalled across access/haul roads at the end of each working day.

CONSTRUCTION MATERIALS MANAGEMENT

(3-19-19) (rev. 04-27-19)

Description

The requirements set forth shall be adhered to in order to meet the applicable materials handling requirements of the NCG010000 permit. Structural controls installed to manage construction materials stored or used on site shall be shown on the E&SC Plan. Requirements for handling materials on construction sites shall be as follows:

Polyacrylamides (PAMS) and Flocculants

Polyacrylamides (PAMS) and flocculants shall be stored in leak-proof containers that are kept under storm-resistant cover or surrounded by secondary containment structures designed to protect adjacent surface waters. PAMS or other flocculants used shall be selected from the NC DWR List of Approved PAMS/Flocculants. The concentration of PAMS and other flocculants used shall not exceed those specified in the NC DWR List of Approved PAMS/Flocculants and in accordance with the manufacturer's instructions. The NC DWR List of Approved PAMS/Flocculants is available at:

https://files.nc.gov/ncdeq/Water%20Quality/Environmental%20Sciences/ATU/ApprovedPAMS_4_1_2017.pdf

Equipment Fluids

Fuels, lubricants, coolants, and hydraulic fluids, and other petroleum products shall be handled and disposed of in a manner so as not to enter surface or ground waters and in accordance with applicable state and federal regulations. Equipment used on the site must be operated and maintained properly to prevent discharge of fluids. Equipment, vehicle, and other wash waters shall not be discharged into E&SC basins or other E&SC devices. Alternative controls should be provided such that there is no discharge of soaps, solvents, or detergents.

Waste Materials

Construction materials and land clearing waste shall be disposed of in accordance with North Carolina General Statutes, Chapter 130A, Article 9 - Solid Waste Management, and rules governing the disposal of solid waste (15A NCAC 13B). Areas dedicated for managing construction material and land clearing waste shall be at least 50 feet away from storm drain inlets and surface waters unless it can be shown that no other alternatives are reasonably available. Paint and other liquid construction material waste shall not be dumped into storm drains. Paint and other liquid construction waste washouts should be located at least 50 feet away from storm drain inlets unless there is no alternative. Other options are to install lined washouts or use portable, removable bags or bins. Hazardous or toxic waste shall be managed in accordance with the federal Resource Conservation and Recovery Act (RCRA) and NC Hazardous Waste Rules at 15A NCAC, Subchapter 13A. Litter and sanitary waste shall be managed in a manner to prevent it from entering jurisdictional waters and shall be disposed of offsite.

Herbicide, Pesticide, and Rodenticides

Herbicide, pesticide, and rodenticides shall be stored and applied in accordance with the Federal Insecticide, Fungicide, and Rodenticide Act, North Carolina Pesticide Law of 1971 and labeling restrictions.

Concrete Materials

Concrete materials onsite, including excess concrete, must be controlled and managed to avoid contact with surface waters, wetlands or buffers. No concrete or cement slurry shall be discharged from the site. (Note that discharges from onsite concrete plants require coverage under a separate NPDES permit – NCG140000.) Concrete wash water shall be managed in accordance with the *Concrete Washout Structure* provision. Concrete slurry shall be managed and disposed of in accordance with *NCDOT DGS and HOS DCAR Distribution of Class A Residuals Statewide* (Permit No. WQ0035749). Any hardened concrete residue will be disposed of, or recycled on site, in accordance with state solid waste regulations.

Earthen Material Stock Piles

Earthen material stock piles shall be located at least 50 feet away from storm drain inlets and surface waters unless it can be shown that no other alternatives are reasonably available.

Measurement and Payment

Conditions set within the *Construction Materials Management* provision are incidental to the project for which no direct compensation will be made.

WASTE AND BORROW SOURCES:

Payment for temporary erosion control measures, except those made necessary by the Contractor's own negligence or for his own convenience, will be paid for at the appropriate contract unit price for the devices or measures utilized in borrow sources and waste areas.

No additional payment will be made for erosion control devices or permanent seeding and mulching in any commercial borrow or waste pit. All erosion and sediment control practices that may be required on a commercial borrow or waste site will be done at the Contractor's expense.

All offsite Staging Areas, Borrow and Waste sites shall be in accordance with "Borrow and Waste Site Reclamation Procedures for Contracted Projects" located at:

<https://connect.ncdot.gov/resources/roadside/FieldOperationsDocuments/ContractedReclamationProcedures.pdf>

All forms and documents referenced in the "Borrow and Waste Site Reclamation Procedures for Contracted Projects" shall be included with the reclamation plans for offsite staging areas, and borrow and waste sites.

SAFETY FENCE AND JURISDICTIONAL FLAGGING:**Description**

Safety Fence shall consist of furnishing materials, installing and maintaining polyethylene or polypropylene fence along the outside riparian buffer, wetland, or water boundary, or other boundaries located within the construction corridor to mark the areas that have been approved to infringe within the buffer, wetland, endangered vegetation, culturally sensitive areas or water. The fence shall be installed prior to any land disturbing activities.

Interior boundaries for jurisdictional areas noted above shall be delineated by stakes and highly visible flagging.

Jurisdictional boundaries at staging areas, waste sites, or borrow pits, whether considered outside or interior boundaries shall be delineated by stakes and highly visible flagging.

Materials**(A) Safety Fencing**

Polyethylene or polypropylene fence shall be a highly visible preconstructed safety fence approved by the Engineer. The fence material shall have an ultraviolet coating.

Either wood posts or steel posts may be used. Wood posts shall be hardwood with a wedge or pencil tip at one end, and shall be at least 5 ft. in length with a minimum nominal 2" x 2" cross section. Steel posts shall be at least 5 ft. in length, and have a minimum weight of 0.85 lb/ft of length.

(B) Boundary Flagging

Wooden stakes shall be 4 feet in length with a minimum nominal 3/4" x 1-3/4" cross section. The flagging shall be at least 1" in width. The flagging material shall be vinyl and shall be orange in color and highly visible.

Construction Methods

No additional clearing and grubbing is anticipated for the installation of this fence. The fence shall be erected to conform to the general contour of the ground.

(A) Safety Fencing

Posts shall be set at a maximum spacing of 10 ft., maintained in a vertical position and hand set or set with a post driver. Posts shall be installed a minimum of 2 ft. into the ground. If hand set, all backfill material shall be thoroughly tamped. Wood posts may be sharpened to a dull point if power driven. Posts damaged by power driving shall be removed and replaced prior to final

acceptance. The tops of all wood posts shall be cut at a 30-degree angle. The wood posts may, at the option of the Contractor, be cut at this angle either before or after the posts are erected.

The fence geotextile shall be attached to the wood posts with one 2" galvanized wire staple across each cable or to the steel posts with wire or other acceptable means.

Place construction stakes to establish the location of the safety fence in accordance with Article 105-9 or Article 801-1 of the *Standard Specifications*. No direct pay will be made for the staking of the safety fence. All stakeouts for safety fence shall be considered incidental to the work being paid for as "Construction Surveying", except that where there is no pay item for construction surveying, all safety fence stakeout will be performed by state forces.

The Contractor shall be required to maintain the safety fence in a satisfactory condition for the duration of the project as determined by the Engineer.

(B) Boundary Flagging

Boundary flagging delineation of interior boundaries shall consist of wooden stakes on 25 feet maximum intervals with highly visible orange flagging attached. Stakes shall be installed a minimum of 6" into the ground. Interior boundaries may be staked on a tangent that runs parallel to buffer but must not encroach on the buffer at any location. Interior boundaries of hand clearing shall be identified with a different colored flagging to distinguish it from mechanized clearing.

Boundary flagging delineation of interior boundaries will be placed in accordance with Article 105-9 or Article 801-1 of the *Standard Specifications*. No direct pay will be made for delineation of the interior boundaries. This delineation will be considered incidental to the work being paid for as *Construction Surveying*, except that where there is no pay item or construction surveying the cost of boundary flagging delineation shall be included in the unit prices bid for the various items in the contract. Installation for delineation of all jurisdictional boundaries at staging areas, waste sites, or borrow pits shall consist of wooden stakes on 25 feet maximum intervals with highly visible orange flagging attached. Stakes shall be installed a minimum of 6" into the ground. Additional flagging may be placed on overhanging vegetation to enhance visibility but does not substitute for installation of stakes.

Installation of boundary flagging for delineation of all jurisdictional boundaries at staging areas, waste sites, or borrow pits shall be performed in accordance with Subarticle 230-4(B)(5) or Subarticle 802-2(F) of the *Standard Specifications*. No direct pay will be made for this delineation, as the cost of same shall be included in the unit prices bid for the various items in the contract.

The Contractor shall be required to maintain alternative stakes and highly visible flagging in a satisfactory condition for the duration of the project as determined by the Engineer.

Measurement and Payment

Safety Fence will be measured and paid as the actual number of linear feet of polyethylene or polypropylene fence installed in place and accepted. Such payment will be full compensation

including but not limited to furnishing and installing fence geotextile with necessary posts and post bracing, staples, tie wires, tools, equipment and incidentals necessary to complete this work.

Payment will be made under:

Pay Item	Pay Unit
Safety Fence	Linear Foot

SKIMMER BASIN WITH BAFFLES: (East)

Description

Provide a skimmer basin to remove sediment from construction site runoff at locations shown in the erosion control plans. See the Skimmer Basin with Baffles Detail sheet provided in the erosion control plans. Work includes constructing sediment basin, installation of temporary slope drain pipe and coir fiber baffles, furnishing, installation and cleanout of skimmer, providing and placing stone pad on bottom of basin underneath skimmer device, providing and placing a geotextile spillway liner, providing coir fiber mat stabilization for the skimmer outlet, disposing of excess materials, removing temporary slope drain, coir fiber baffles, geotextile liner and skimmer device, backfilling basin area with suitable material and providing proper drainage when basin area is abandoned.

Materials

Item	Section
Stone for Erosion Control, Class B	1042
Geotextile for Soil Stabilization, Type 4	1056
Fertilizer for Temporary Seeding	1060-2
Seed for Temporary Seeding	1060-4
Seeding and Mulching	1060-4
Matting for Erosion Control	1060-8
Staples	1060-8
Coir Fiber Mat	1060-14
Temporary Slope Drain	1622-2
Coir Fiber Baffle	1640

Provide appropriately sized and approved skimmer device.

Provide Schedule 40 PVC pipe with a length of 6 ft. to attach to the skimmer and the coupling connection to serve as the arm pipe. For skimmer sizes of 2.5 in. and smaller, the arm pipe diameter shall be 1.5 inches. For skimmer sizes of 3 in. and larger, refer to manufacturer recommendation.

Provide 4" diameter Schedule 40 PVC pipe to attach to coupling connection of skimmer to serve as the barrel pipe through the earthen dam.

The geotextile for the spillway liner shall meet the following minimum physical properties for low permeability, woven polypropylene geotextiles:

Property	Test Method	Value	Unit
Tensile Strength	ASTM D-4632	315	lb.
Tensile Elongation (Maximum)	ASTM D-4632	15	%
Trapezoidal Tear	ASTM D-4533	120	lbs.
CBR Puncture	ASTM D-6241	900	lbs.
UV Resistance (% retained at 500 hrs.)	ASTM D-4355	70	%
Apparent Opening Size (AOS)	ASTM D-4751	40	US Std. Sieve
Permittivity	ASTM D-4491	0.05	sec ⁻¹
Water Flow Rate	ASTM D-4491	4	gal/min/ft ²

Anchors: Staples, stakes, or reinforcement bars shall be used as anchors.

Wooden Stakes:

Provide hardwood stakes 12"- 24" long with a 2" x 2" nominal square cross section. One end of the stake must be sharpened or beveled to facilitate driving through the coir fiber mat and down into the underlying soil. The other end of the stake needs to have a 1"- 2" long head at the top with a 1"- 2" notch following to catch and secure the coir fiber mat.

Steel Reinforcement Bars:

Provide uncoated #10 steel reinforcement bars 24" nominal length. The bars shall have a 4" diameter bend at one end with a 4" straight section at the tip to catch and secure the coir fiber mat.

Staples:

Provide staples made of 0.125" diameter new steel wire formed into a *u* shape not less than 12" in length with a throat of 1" in width.

Construction Methods

Excavate basin according to the erosion control plans with basin surface free of obstructions, debris, and pockets of low-density material. Install temporary slope drain pipe and construct the primary spillway according to the Skimmer Basin with Baffles Detail sheet in the erosion control plans. Temporary slope drain pipe at inlet of basin may be replaced by Type 4 geotextile as directed. Construct the coir fiber baffles according to *Roadway Standard Drawings* No. 1640.01 and Section 1640 of the *Standard Specifications*.

Install skimmer device according to manufacturer recommendations. Install 4" Schedule 40 PVC pipe into dam on the lower side of basin 1 ft. from the bottom of the basin and according to the detail, and extend the pipe so the basin will drain. Attach a 6 ft. arm pipe to the coupling connection

and skimmer according to manufacturer recommendations. The coupling shall be rigid and non-buoyant and not exceed a diameter of 4" and 12" in length. Attach the rope included with the skimmer to the tee between the vent socket and the tube inlet, and the other end to a wooden stake or metal post. Clean out skimmer device when it becomes clogged with sediment and/or debris and is unable to float at the top of water in skimmer basin. Take appropriate measures to avoid ice accumulation in the skimmer device. Construct a stone pad of Class B stone directly underneath the skimmer device at bottom of basin. The pad shall be a minimum of 12" in height, and shall have a minimum cross sectional area of 4 ft. by 4 ft.

Line primary spillway with low permeability polypropylene geotextile unrolled in the direction of flow and lay smoothly but loosely on soil surface without creases. Bury edges of geotextile in a trench at least 5" deep and tamp firmly. If geotextile for the primary spillway is not one continuous piece of material, make horizontal overlaps a minimum of 18" with upstream geotextile overlapping the downstream geotextile. Secure geotextile with eleven gauge wire staples shaped into a *u* shape with a length of not less than 12" and a throat not less than 1" in width. Place staples along outer edges and throughout the geotextile a maximum of 3 ft. horizontally and vertically. Geotextile shall be placed to the bottom and across the entire width of the basin according to the Skimmer Basin with Baffles detail. Place sealant inside basin around barrel pipe on top of geotextile with a minimum width of 6 in.

At the skimmer outlet, provide a smooth soil surface free from stones, clods, or debris that will prevent contact of the coir fiber matting with the soil. Unroll the matting and apply without stretching such that it will lie smoothly but loosely on the soil surface. Wooden stakes, reinforcement bars, or staples may be used as anchors in accordance with the details in the plans and as directed. Place anchors across the matting at the ends approximately 1 ft. apart. Place anchors along the outer edges and down the center of the matting 3 ft. apart.

All bare side slope sections of the skimmer basin shall be seeded with a temporary or permanent seed mix as directed and in accordance with Articles 1620-3, 1620-4, 1620-5, 1660-4, 1660-5 and 1660-7 of the *Standard Specifications*. Straw or excelsior matting shall be installed on all bare side slope sections immediately upon the completion of seeding and in accordance with Article 1631-3 of the *Standard Specifications*.

Measurement and Payment

Silt Excavation will be measured and paid for in accordance with Article 1630-4 of the *Standard Specifications*, as calculated from the typical section throughout the length of the basin as shown on the final approved plans.

Geotextile for Soil Stabilization will be measured and paid for in accordance with Article 270-4 of the *Standard Specifications*.

Low Permeability Geotextile will be measured and paid for as the actual number of square yards measured along the surface of the spillway over which the geotextile is installed and accepted.

Coir Fiber Baffles will be measured and paid for in accordance with Article 1640-4 of the *Standard Specifications*.

__" *Skimmer* will be measured in units of each. __" *Skimmer* will be measured and paid for as the maximum number of each size skimmer acceptably installed and in use at any one time during the life of the project. Barrel and arm pipe, cleanout, relocation and reinstallation of __" *Skimmer* is considered incidental to the measurement of the quantity of __" *Skimmer* and no separate payment will be made. No separate payment shall be made if __" *Skimmer*, barrel and/or arm pipe(s) are damaged by ice accumulation.

Coir Fiber Mat will be measured and paid for as the actual number of square yards measured along the surface of the ground over which coir fiber mat is installed and accepted.

Temporary Slope Drain will be measured and paid for in accordance with Article 1622-4 of the *Standard Specifications*.

Stone for Erosion Control, Class __ will be measured and paid for in accordance with Article 1610-4 of the *Standard Specifications*.

Seeding and Mulching will be measured and paid for in accordance with Article 1660-8 of the *Standard Specifications*.

Seed for Temporary Seeding will be measured and paid for in accordance with Article 1620-6 of the *Standard Specifications*.

Fertilizer for Temporary Seeding will be measured and paid for in accordance with Article 1620-6 of the *Standard Specifications*.

Matting for Erosion Control will be measured and paid for in accordance with Article 1631-4 of the *Standard Specifications*.

No measurement will be made for other items or for over excavation or stockpiling.

Payment will be made under:

Pay Item	Pay Unit
__" Skimmer	Each
Coir Fiber Mat	Square Yard
Low Permeability Geotextile	Square Yard

EARTHEN DAM WITH SKIMMER: **(East)**

Description

Provide an earthen dam with a skimmer attached to a barrel pipe at the outlet of a proposed roadway ditch to remove sediment from construction site runoff at locations shown in the erosion

control plans. See the Earthen Dam with Skimmer Detail sheet provided in the erosion control plans. Work includes constructing earthen dam, installation of coir fiber baffles, furnishing, installation and cleanout of skimmer, providing and placing stone pad on bottom of ditch underneath skimmer device, providing and placing geotextile spillway liner, providing coir fiber mat stabilization for the skimmer outlet, removing earthen dam, coir fiber baffles, geotextile liner and skimmer device, and disposing of excess materials.

Materials

Item	Section
Stone for Erosion Control, Class B	1042
Staples	1060-8
Coir Fiber Mat	1060-14
Coir Fiber Baffle	1640

Provide appropriately sized and approved skimmer device.

Provide Schedule 40 PVC pipe with a length of 6 ft. to attach to the skimmer and the coupling connection to serve as the arm pipe. For skimmer sizes of 2.5 in. and smaller, the arm pipe diameter shall be 1.5 inches. For skimmer sizes of 3 in. and larger, refer to manufacturer recommendation.

Provide 4" diameter Schedule 40 PVC pipe to attach to coupling connection of skimmer to serve as the barrel pipe through the earthen dam.

The geotextile for the spillway liner shall meet the following minimum physical properties for low permeability, woven polypropylene geotextiles:

Property	Test Method	Value	Unit
Tensile Strength	ASTM D-4632	315	lb.
Tensile Elongation (Maximum)	ASTM D-4632	15	%
Trapezoidal Tear	ASTM D-4533	120	lbs.
CBR Puncture	ASTM D-6241	900	lbs.
UV Resistance (% retained at 500 hrs.)	ASTM D-4355	70	%
Apparent Opening Size (AOS)	ASTM D-4751	40	US Std. Sieve
Permittivity	ASTM D-4491	0.05	sec ⁻¹
Water Flow Rate	ASTM D-4491	4	gal/min/ft ²

Anchors: Staples, stakes, or reinforcement bars shall be used as anchors.

Wooden Stakes:

Provide hardwood stakes 12"- 24" long with a 2" x 2" nominal square cross section. One end of the stake must be sharpened or beveled to facilitate driving through the coir fiber mat and down into the underlying soil. The other end of the stake needs to have a 1"- 2" long head at the top with a 1"- 2" notch following to catch and secure the coir fiber mat.

Steel Reinforcement Bars:

Provide uncoated #10 steel reinforcement bars 24" nominal length. The bars shall have a 4" diameter bend at one end with a 4" straight section at the tip to catch and secure the coir fiber mat.

Staples:

Provide staples made of 0.125" diameter new steel wire formed into a *u* shape not less than 12" in length with a throat of 1" in width.

Construction Methods

Excavate proposed ditch according to the roadway plans and cross sections with ditch surface free of obstructions, debris, and pockets of low-density material. Construct earthen dam and install the primary spillway according to the Earthen Dam with Skimmer Detail sheet in the erosion control plans. Construct the coir fiber baffles according to *Roadway Standard Drawings* No. 1640.01 and Section 1640 of the *Standard Specifications*. Accumulated silt behind the earthen dam and baffles shall be removed regularly and as directed.

Install skimmer device according to manufacturer recommendations. Install 4" Schedule 40 PVC pipe into dam on the lower side of basin 1 ft. from the bottom of the basin and according to the detail, and extend the pipe so the basin will drain. Attach a 6 ft. arm pipe to the coupling connection and skimmer according to manufacturer recommendations. The coupling shall be rigid and non-buoyant and not exceed a diameter of 4" and 12" in length. Attach the rope included with the skimmer to the tee between the vent socket and the tube inlet, and the other end to a wooden stake or metal post. Clean out skimmer device when it becomes clogged with sediment and/or debris and is unable to float at the top of water impounded in the ditch. Take appropriate measures to avoid ice accumulation in the skimmer device. Construct a stone pad of Class B stone directly underneath the skimmer device at bottom of ditch. The pad shall be a minimum of 12" in height, and shall have a minimum cross sectional area of 4 ft. by 4 ft.

Line primary spillway with low permeability polypropylene geotextile unrolled in the direction of flow and lay smoothly but loosely on soil surface without creases. Bury edges of geotextile in a trench at least 5" deep and tamp firmly. If geotextile for the primary spillway is not one continuous piece of material, make horizontal overlaps a minimum of 18" with upstream geotextile overlapping the downstream geotextile. Secure geotextile with eleven gauge wire staples shaped into a *u* shape with a length of not less than 12" and a throat not less than 1" in width. Place staples along outer edges and throughout the geotextile a maximum of 3 ft. horizontally and vertically. Geotextile shall be placed to the bottom and across the entire width of the ditch according to the Earthen Dam with Skimmer Detail. Place sealant inside basin around barrel pipe on top of geotextile with a minimum width of 6 in.

At the skimmer outlet, provide a smooth soil surface free from stones, clods, or debris that will prevent contact of the coir fiber matting with the soil. Unroll the matting and apply without stretching such that it will lie smoothly but loosely on the soil surface. Wooden stakes,

reinforcement bars, or staples may be used as anchors in accordance with the details in the plans and as directed. Place anchors across the matting at the ends approximately 1 ft. apart. Place anchors along the outer edges and down the center of the matting 3 ft. apart.

Measurement and Payment

The construction of the earthen dam will be paid for as *Borrow Excavation* as provided in Section 230 of the *Standard Specifications* or included in the lump sum price for grading.

Silt Excavation will be measured and paid for in accordance with Article 1630-4 of the *Standard Specifications*, as calculated from the typical section throughout the length of the ditch as shown on the final approved plans.

Low Permeability Geotextile will be measured and paid for as the actual number of square yards measured along the surface of the spillway over which the geotextile is installed and accepted.

Coir Fiber Baffles will be measured and paid for in accordance with Article 1640-4 of the *Standard Specifications*.

__" *Skimmer* will be measured in units of each. __" *Skimmer* will be measured and paid for as the maximum number of each size skimmer acceptably installed and in use at any one time during the life of the project. Barrel and arm pipe, cleanout, relocation and reinstallation of __" *Skimmer* is considered incidental to the measurement of the quantity of __" *Skimmer* and no separate payment will be made. No separate payment shall be made if __" *Skimmer*, barrel and/or arm pipe(s) are damaged by ice accumulation.

Coir Fiber Mat will be measured and paid for as the actual number of square yards measured along the surface of the ground over which coir fiber mat is installed and accepted.

Stone for Erosion Control, Class __ will be measured and paid for in accordance with Article 1610-4 of the *Standard Specifications*.

No measurement will be made for other items or for over excavation or stockpiling.

Payment will be made under:

Pay Item	Pay Unit
__" <i>Skimmer</i>	Each
<i>Coir Fiber Mat</i>	Square Yard
<i>Low Permeability Geotextile</i>	Square Yard

COIR FIBER WATTLES WITH POLYACRYLAMIDE (PAM):**Description**

Coir Fiber Wattles are tubular products consisting of coir fibers (coconut fibers) encased in coir fiber netting. Coir Fiber Wattles are used on slopes or channels to intercept runoff and act as a velocity break. Coir Fiber Wattles are to be placed at locations shown on the plans or as directed. Installation shall follow the detail provided in the plans and as directed. Work includes furnishing materials, installation of coir fiber wattles, matting installation, PAM application, and removing wattles.

Materials

Coir Fiber Wattle shall meet the following specifications:

100% Coir (Coconut) Fibers	
Minimum Diameter	12 in.
Minimum Density	3.5 lb/ft ³ +/- 10%
Net Material	Coir Fiber
Net Openings	2 in. x 2 in.
Net Strength	90 lbs.
Minimum Weight	2.6 lbs./ft. +/- 10%

Anchors: Stakes shall be used as anchors.

Wooden Stakes:

Provide hardwood stakes a minimum of 2-ft. long with a 2 in. x 2 in. nominal square cross section. One end of the stake must be sharpened or beveled to facilitate driving down into the underlying soil.

Matting shall meet the requirements of Article 1060-8 of the *Standard Specifications*, or shall meet specifications provided elsewhere in this contract.

Provide staples made of 0.125" diameter new steel wire formed into a *u* shape not less than 12" in length with a throat of 1" in width.

Polyacrylamide (PAM) shall be applied in powder form and shall be anionic or neutrally charged. Soil samples shall be obtained in areas where the wattles will be placed, and from offsite material used to construct the roadway, and analyzed for the appropriate PAM flocculant to be utilized with each wattle. The PAM product used shall be listed on the North Carolina Department of Environmental Quality Division of Water Resources web site as an approved PAM product for use in North Carolina.

Construction Methods

Coir Fiber Wattles shall be secured to the soil by wire staples approximately every 1 linear foot and at the end of each section of wattle. A minimum of 4 stakes shall be installed on the downstream side of the wattle with a maximum spacing of 2 linear feet along the wattle, and according to the detail. Install a minimum of 2 stakes on the upstream side of the wattle according to the detail provided in the plans. Stakes shall be driven into the ground a minimum of 10 in. with no more than 2 in. projecting from the top of the wattle. Drive stakes at an angle according to the detail provided in the plans.

Only install coir fiber wattle(s) to a height in ditch so flow will not wash around wattle and scour ditch slopes and according to the detail provided in the plans and as directed. Overlap adjoining sections of wattles a minimum of 6 in.

Installation of matting shall be in accordance with the detail provided in the plans, and in accordance with Article 1631-3 of the *Standard Specifications*, or in accordance with specifications provided elsewhere in this contract.

Apply PAM over the lower center portion of the coir fiber wattle where the water is going to flow over at a rate of 2 ounces per wattle, and 1 ounce of PAM on matting on each side of the wattle. PAM applications shall be done during construction activities after every rainfall event that is equal to or exceeds 0.50 in.

The Contractor shall maintain the coir fiber wattles until the project is accepted or until the wattles are removed, and shall remove and dispose of silt accumulations at the wattles when so directed in accordance with the requirements of Section 1630 of the *Standard Specifications*.

Measurement and Payment

Coir Fiber Wattles will be measured and paid for by the actual number of linear feet of wattles which are installed and accepted. Such price and payment will be full compensation for all work covered by this section, including, but not limited to, furnishing all materials, labor, equipment and incidentals necessary to install the *Coir Fiber Wattles*.

Matting will be measured and paid for in accordance with Article 1631-4 of the *Standard Specifications*, or in accordance with specifications provided elsewhere in this contract.

Polyacrylamide(PAM) will be measured and paid for by the actual weight in pounds of PAM applied to the coir fiber wattles. Such price and payment will be full compensation for all work covered by this section, including, but not limited to, furnishing all materials, labor, equipment and incidentals necessary to apply the *Polyacrylamide(PAM)*.

Payment will be made under:

Pay Item	Pay Unit
Polyacrylamide(PAM)	Pound
Coir Fiber Wattle	Linear Foot

TEMPORARY ROCK SILT CHECK TYPE A WITH EXCELSIOR MATTING AND POLYACRYLAMIDE (PAM):

Description

Temporary Rock Silt Checks Type A with Excelsior Matting and Polyacrylamide (PAM) are devices utilized in temporary and permanent ditches to reduce runoff velocity and incorporate PAM into the construction runoff to increase settling of sediment particles and reduce turbidity of runoff. Temporary Rock Silt Checks Type A with Excelsior Matting and PAM are to be placed at locations shown on the plans or as directed. Installation shall follow the detail provided in the plans and as directed. Work includes furnishing materials, installation of Temporary Rock Silt Checks Type A, matting installation, PAM application, and removing Temporary Rock Silt Checks Type A with Excelsior Matting and PAM.

Materials

Structural stone shall be class B stone that meets the requirements of Section 1042 of the *Standard Specifications* for Stone for Erosion Control, Class B.

Sediment control stone shall be #5 or #57 stone, which meets the requirements of Section 1005 of the *Standard Specifications* for these stone sizes.

Matting shall meet the requirements of Excelsior Matting in Subarticle 1060-8(B) of the *Standard Specifications*, or shall meet specifications provided elsewhere in this contract.

Polyacrylamide (PAM) shall be applied in powder form and shall be anionic or neutrally charged. Soil samples shall be obtained in areas where the Temporary Rock Silt Checks Type A with Excelsior Matting and PAM will be placed, and from offsite material used to construct the roadway, and analyzed for the appropriate PAM flocculant to be utilized with each Temporary Rock Silt Check Type A. The PAM product used shall be listed on the North Carolina Department of Environmental Quality Division of Water Resources web site as an approved PAM product for use in North Carolina.

Construction Methods

Temporary Rock Silt Checks Type A shall be installed in accordance with Subarticle 1633-3(A) of the *Standard Specifications*, Roadway Standard Drawing No. 1633.01 and the detail provided in the plans.

Installation of matting shall be in accordance with the detail provided in the plans, and anchored by placing Class B stone on top of the matting at the upper and lower ends.

Apply PAM at a rate of 4 ounces over the center portion of the Temporary Rock Silt Checks Type A and matting where the water is going to flow over. PAM applications shall be done during construction activities and after every rainfall event that is equal to or exceeds 0.50 in.

The Contractor shall maintain the Temporary Rock Silt Checks Type A with Excelsior Matting and PAM until the project is accepted or until the Temporary Rock Silt Checks Type A with Excelsior Matting and PAM are removed, and shall remove and dispose of silt accumulations at the Temporary Rock Silt Checks Type A with Excelsior Matting and PAM when so directed in accordance with the requirements of Section 1630 of the *Standard Specifications*.

Measurement and Payment

Temporary Rock Silt Checks Type A will be measured and paid for in accordance with Article 1633-5 of the *Standard Specifications*, or in accordance with specifications provided elsewhere in this contract.

Matting will be measured and paid for in accordance with Article 1631-4 of the *Standard Specifications*, or in accordance with specifications provided elsewhere in this contract.

Polyacrylamide(PAM) will be measured and paid for by the actual weight in pounds of PAM applied to the Temporary Rock Silt Checks Type A. Such price and payment will be full compensation for all work covered by this section, including, but not limited to, furnishing all materials, labor, equipment and incidentals necessary to apply the *Polyacrylamide(PAM)*.

Payment will be made under:

Pay Item	Pay Unit
Polyacrylamide(PAM)	Pound

IMPERVIOUS DIKE:

Description

This work consists of furnishing, installing, maintaining, and removing an *Impervious Dike* for the purpose of diverting normal stream flow around the construction site. The Contractor shall construct an impervious dike in such a manner approved by the Engineer. The impervious dike shall not permit seepage of water into the construction site or contribute to siltation of the stream. The impervious dike shall be constructed of an acceptable material in the locations noted on the plans or as directed.

Materials

Acceptable materials shall include but not be limited to sheet piles, sandbags, and/or the placement of an acceptable size stone lined with polypropylene or other impervious geotextile.

Earth material shall not be used to construct an impervious dike when it is in direct contact with the stream unless vegetation can be established before contact with the stream takes place.

Measurement and Payment

Impervious Dike will be measured and paid as the actual number of linear feet of impervious dike(s) constructed, measured in place from end to end of each separate installation that has been completed and accepted. Such price and payment will be full compensation for all work including but not limited to furnishing materials, construction, maintenance, and removal of the impervious dike.

Payment will be made under:

Pay Item

Impervious Dike

Pay Unit

Linear Foot

TEMPORARY PIPE FOR CULVERT CONSTRUCTION:**Description**

This work consists of furnishing, installing, maintaining and removing any and all temporary pipe used on this project in conjunction with the culvert construction.

Construction Methods

The Contractor shall install temporary pipe in locations shown on the plans in such a manner approved by the Engineer. The temporary pipe shall provide a passageway for the stream through the work-site. The minimum size requirements will be as stated on the erosion control plans.

Measurement and Payment

___" *Temporary Pipe* will be measured and paid for at the contract unit price per linear foot of temporary pipe approved by the Engineer and measured in place from end to end. Such price and payment will be full compensation for all work covered by this section including but not limited to furnishing all materials required for installation, construction, maintenance, and removal of temporary pipe.

Payment will be made under:

Pay Item

___" Temporary Pipe

Pay Unit

Linear Foot

COIR FIBER MAT:**Description**

Furnish material, install and maintain coir fiber mat in locations shown on the plans or in locations as directed. Work includes providing all materials, excavating and backfilling, and placing and securing coir fiber mat with stakes, steel reinforcement bars or staples as directed.

Materials

Item	Section
Coir Fiber Mat	1060-14

Anchors: Stakes, reinforcement bars, or staples shall be used as anchors.

Wooden Stakes:

Provide hardwood stakes 12"- 24" long with a 2" x 2" nominal square cross section. One end of the stake must be sharpened or beveled to facilitate driving through the coir fiber mat and down into the underlying soil. The other end of the stake needs to have a 1"- 2" long head at the top with a 1"- 2" notch following to catch and secure the coir fiber mat.

Steel Reinforcement Bars:

Provide uncoated #10 steel reinforcement bars 24" nominal length. The bars shall have a 4" diameter bend at one end with a 4" straight section at the tip to catch and secure the coir fiber mat.

Staples:

Provide staples made of 0.125" diameter new steel wire formed into a *u* shape not less than 12" in length with a throat of 1" in width.

Construction Methods

Place the coir fiber mat immediately upon final grading. Provide a smooth soil surface free from stones, clods, or debris that will prevent the contact of the mat with the soil. Unroll the mat and apply without stretching such that it will lie smoothly but loosely on the soil surface.

For stream relocation applications, take care to preserve the required line, grade, and cross section of the area covered. Bury the top slope end of each piece of mat in a narrow trench at least 6 in. deep and tamp firmly. Where one roll of matting ends and a second roll begins, overlap the end of the upper roll over the buried end of the second roll so there is a 6 in. overlap. Construct check trenches at least 12 in. deep every 50 ft. longitudinally along the edges of the mat or as directed. Fold over and bury mat to the full depth of the trench, close and tamp firmly. Overlap mat at least 6 in. where 2 or more widths of mat are installed side by side.

Place anchors across the mat at the ends approximately 1 ft. apart. Place anchors along the outer edges and down the center of the mat 3 ft. apart.

Adjustments in the trenching or anchoring requirements to fit individual site conditions may be required.

Measurement and Payment

Coir Fiber Mat will be measured and paid for as the actual number of square yards measured along the surface of the ground over which coir fiber mat is installed and accepted.

No measurement will be made for anchor items.

Payment will be made under:

Pay Item	Pay Unit
Coir Fiber Mat	Square Yard

CONCRETE WASHOUT STRUCTURE:

(01-03-19)

Description

Concrete washout structures are enclosures above or below grade to contain concrete waste water and associated concrete mix from washing out ready-mix trucks, drums, pumps, or other equipment. Concrete washouts must collect and retain all the concrete washout water and solids, so that this material does not migrate to surface waters or into the ground water. These enclosures are not intended for concrete waste not associated with wash out operations.

The concrete washout structure may include constructed devices above or below ground and or commercially available devices designed specifically to capture concrete wash water.

Materials

Item	Section
Temporary Silt Fence	1605

Safety Fence shall meet the specifications as provided elsewhere in this contract.

Geomembrane basin liner shall meet the following minimum physical properties for low permeability; it shall consist of a polypropylene or polyethylene 10 mil thick geomembrane. If the minimum setback dimensions can be achieved the liner is not required. (5 feet above groundwater, 50 feet from top of bank of perennial stream, other surface water body, or wetland.)

Construction Methods

Build an enclosed earthen berm or excavate to form an enclosure in accordance with the details and as directed.

Install temporary silt fence around the perimeter of the enclosure in accordance with the details and as directed if structure is not located in an area where existing erosion and sedimentation control devices are capable to containing any loss of sediment.

Post a sign with the words "Concrete Washout" in close proximity of the concrete washout area, so it is clearly visible to site personnel. Install safety fence as directed for visibility to construction traffic.

The construction details for the above grade and below grade concrete washout structures can be found on the following web page link:

<https://connect.ncdot.gov/resources/roadside/SoilWaterDocuments/ConcreteWashoutStructuredetail.pdf>

Alternate details for accommodating concrete washout may be submitted for review and approval.

The alternate details shall include the method used to retain and dispose of the concrete waste water within the project limits and in accordance with the minimum setback requirements. (5 feet above groundwater, 50 feet from top of bank of perennial stream, other surface water body, or wetland.)

Maintenance and Removal

Maintain the concrete washout structure(s) to provide adequate holding capacity plus a minimum freeboard of 12 inches. Remove and dispose of hardened concrete and return the structure to a functional condition after reaching 75% capacity.

Inspect concrete washout structures for damage and maintain for effectiveness.

Remove the concrete washout structures and sign upon project completion. Grade the earth material to match the existing contours and permanently seed and mulch area.

Measurement and Payment

Concrete Washout Structure will be paid for per each enclosure installed in accordance with the details. If alternate details are approved then those details will also be paid for per each approved and installed device.

Temporary Silt Fence will be measured and paid for in accordance with Article 1605-5 of the *Standard Specifications*.

No measurement will be made for other items or for over excavation or stockpiling.

Payment will be made under:

Pay Item	Pay Unit
Concrete Washout Structure	Each

PUMP AROUND OPERATION:

Description

The work covered by this section consists of furnishing, installing, maintaining and removing any and all pump around systems used on this project. The Contractor shall install a pump around system in locations as shown in the plans and in other locations approved by the Engineer. The pump around system shall provide a passageway for the stream flow around the work site.

The quantity of pump around systems may be increased, decreased, or eliminated entirely as directed. Such variations in quantity will not be considered as alterations in the details of construction or a change in the character of the work. See NCDOT *Best Management Practices for Construction and Maintenance Activities* manual for example pump around operation.

Materials

Item	Section
Special Stilling Basin	1639

Impervious Dike shall meet the specifications as provided elsewhere in this contract.

Pumps shall be of sufficient size to divert the stream flow around the work area, as approved by the Engineer.

Construction Methods

Install *impervious dike(s)* as shown on the plans or as directed. Pump water around the work site. If the water is turbid or exposed to bare soil, pump through a *special stilling basin*. Once the work is complete in an area remove the *impervious dike(s)* and pump system, and stabilize the area.

Measurement and Payment

Impervious Dike will be measured and paid for as provided elsewhere in this contract.

Special Stilling Basin will be measured and paid for in accordance with Article 1639-4 of the *Standard Specifications*.

Payment for pumping operations shall be considered incidental to the work of installing pipes and culverts. The pumping operations shall include but not be limited to, diverting the stream flow

around the work area and pumping runoff from the work area into a stilling basin, special stilling basin or other sediment control device. No additional payment will be made for furnishing materials or maintenance of the pumping operations for the installation of pipes and culverts.

The above prices and payments will be full compensation for all work covered by this section including, but not limited to furnishing all of the necessary materials, construction, maintenance and removal of the impervious dike and pump around system.

FABRIC INSERT INLET PROTECTION DEVICE (HIGH FLOW)

(6-29-17)

Description

This work shall consist of installing, maintaining, and removing *Fabric Inlet Protection Device*, of the type specified, in inlet structures (catch basins, drop inlets, etc) in areas where asphalt or concrete may prevent the proper installation of a Rock Inlet Sediment Traps Type C, or as directed.

Materials

The product shall be a fabric inlet protection device composed of a fitted woven polypropylene geotextile double sewn with nylon thread suspended sack. The *Fabric Inlet Protection Device* shall be manufactured to fit the opening of the catch basin or drop inlet or shall have a deflector to direct runoff from the curb opening into the fabric sack. The *Fabric Inlet Protection Device* shall have a rigid frame or support system to support the loaded weight of the product. The product shall have lifting loops for removing the device from the basin and will have dump straps attached at the bottom to facilitate the emptying of the device. The *Fabric Inlet Protection Device* shall have an overflow system to allow stormwater to enter the inlet structure and avoid ponding on the roadway when the device reaches capacity

The stitching shall meet the following physical properties:

Physical	Test Method	English
Average Wide Width Strength	ASTM D-4884	165 lb/in

The fitted filter assembly shall have the following physical properties:

Physical	Test Method	English
Grab Tensile	ASTM D-4632	255 x 275 lbs
Minimum Puncture Strength	ASTM D-4833	125 lbs
Mullen Burst	ASTM D-3786	420 PSI
Minimum UV Resistance	ASTM D-4355	70 %.
Flow Rate	ASTM D-4491	200 gal/min/ft ²
Apparent Opening	ASTM D-4751	20 US Sieve
Permittivity	ASTM D-4491	1.5 sec ⁻¹

Construction Methods

Strictly comply with manufacturer's installation instructions and recommendations. Maintenance shall include regular daily inspections and after each qualifying rain event. The *Fabric Insert Inlet Protection Device* shall be emptied, cleaned and placed back into the basin when it reaches 50% capacity or as directed.

Measurement and Payment

This work will be paid for at the contract unit price per *Fabric Insert Inlet Protection Device* of the type specified, complete in place and accepted. Such payment shall be full compensation for furnishing and installing the *Fabric Insert Inlet Protection Device* in accordance with this specification and for all required maintenance.

Maintenance of the device, cleanout and disposal of accumulated sediments shall be paid for by *Fabric Insert Inlet Protection Device Cleanout*.

Payment will be made under:

Pay Item	Pay Unit
Fabric Insert Inlet Protection Device	Each
Fabric Insert Inlet Protection Device Cleanout	Each

U-2714

TS-1

Wayne County

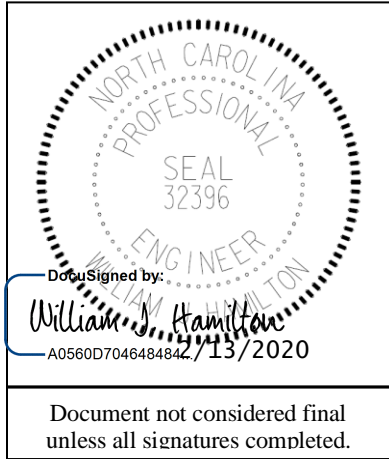

**Signals and Intelligent Transportation Systems
Project Special Provisions
(Version 18.2)**

*Prepared By: WJH
13-Feb-20*

Contents

1. 2018 STANDARD SPECIFICATIONS FOR ROADS & STRUCTURES3

1.1. GENERAL REQUIREMENTS – CONSTRUCTION METHODS (1700-3(K))..... 3

1.2. WOOD POLES – CONSTRUCTION METHODS (1720-3) 3

2. SIGNAL HEADS.....3

2.1. MATERIALS 3

A. General:..... 3

B. Vehicle Signal Heads: 5

C. Pedestrian Signal Heads: 7

D. Signal Cable: 9

3. CONTROLLERS WITH CABINETS9

3.1. MATERIALS – GENERAL CABINETS 9

3.2. MATERIALS – TYPE 170E CABINETS 10

A. Type 170 E Cabinets General:..... 10

B. Type 170 E Cabinet Electrical Requirements: 10

C. Type 170 E Cabinet Physical Requirements: 17

D. Model 2018 Enhanced Conflict Monitor: 18

E. Preemption and Sign Control Box..... 28

3.3. MATERIALS – TYPE 170 DETECTOR SENSOR UNITS 31

3.4. MATERIALS – TYPE 2070E CONTROLLERS 31

4. MICROWAVE VEHICLE DETECTION SYSTEM - MULTIPLE DETECTION ZONES.....31

4.1. DESCRIPTION 31

4.2. MATERIALS 31

4.3. CONSTRUCTION METHODS 32

4.4. MEASUREMENT AND PAYMENT 33

5. TRAFFIC SIGNAL SUPPORTS33

5.1. METAL TRAFFIC SIGNAL SUPPORTS – ALL POLES 33

A. General:..... 33

B. Materials: 35

C. Construction Methods: 36

5.2. METAL POLE UPRIGHTS (VERTICAL MEMBERS) 37

A. Materials: 37

B. Construction Methods: 38

5.3. DRILLED PIER FOUNDATIONS FOR METAL TRAFFIC SIGNAL POLES 38

A. Description: 39

B. Soil Test and Foundation Determination: 39

C. Drilled Pier Construction: 42

5.4. POLE NUMBERING SYSTEM..... 42

A. New Poles 42

U-2714

TS-2

Wayne County

5.5. MEASUREMENT AND PAYMENT42

1. 2018 STANDARD SPECIFICATIONS FOR ROADS & STRUCTURES

The 2018 Standard Specifications are revised as follows:

1.1. GENERAL REQUIREMENTS – Construction Methods (1700-3(K))

Page 17-4, revise sentence starting on line 14 to read “Modify existing electrical services, as necessary, to meet the grounding requirements of the NEC, these *Standard Specifications*, *Standard Drawings*, and the project plans.”

Page 17-4, revise sentence beginning on line 21 to read “Furnish and install additional ground rods to grounding electrode system as necessary to meet the *Standard Specifications*, *Standard Drawings*, and test requirements.”

1.2. WOOD POLES – Construction Methods (1720-3)

Page 17-18, revise sentence starting on line 13 to read “On new Department-owned poles, install a grounding system consisting of #6 AWG solid bare copper wire that is mechanically crimped using an irreversible compression tool with die to a single ground rod installed at base of pole or to the electrical service grounding electrode system located within 10 feet of the pole.”

2. SIGNAL HEADS

2.1. MATERIALS

A. General:

Fabricate vehicle signal head housings and end caps from die-cast aluminum. Fabricate 16-inch pedestrian signal head housings and end caps from die-cast aluminum. Provide visor mounting screws, door latches, and hinge pins fabricated from stainless steel. Provide interior screws, fasteners, and metal parts fabricated from stainless steel.

Fabricate tunnel and traditional visors from sheet aluminum.

Paint all surfaces inside and outside of signal housings and doors. Paint outside surfaces of tunnel and traditional visors, wire outlet bodies, wire entrance fitting brackets and end caps when supplied as components of messenger cable mounting assemblies, pole and pedestal mounting assemblies, and pedestrian pushbutton housings. Have electrostatically-applied, fused-polyester paint in highway yellow (Federal Standard 595C, Color Chip Number 13538) a minimum of 2.5 to 3.5 mils thick. Do not apply paint to the latching hardware, rigid vehicle signal head mounting brackets for mast-arm attachments, messenger cable hanger components or balance adjuster components.

Have the interior surfaces of tunnel and traditional visors painted an alkyd urea black synthetic baking enamel with a minimum gloss reflectance and meeting the requirements of MIL-E-10169, “Enamel Heat Resisting, Instrument Black.”

Where required, provide polycarbonate signal heads and visors that comply with the provisions pertaining to the aluminum signal heads listed on the QPL with the following exceptions:

Fabricate signal head housings, end caps, and visors from virgin polycarbonate material. Provide UV stabilized polycarbonate plastic with a minimum thickness of 0.1 ± 0.01 inches that is highway yellow (Federal Standard 595C, Color Chip 13538). Ensure the color is incorporated into the plastic material before molding the signal head housings and end caps. Ensure the plastic formulation provides the following physical properties in the assembly (tests may be performed on separately molded specimens):

U-2714

TS-4

Wayne County

Test	Required	Method
Specific Gravity	1.17 minimum	ASTM D 792
Flammability	Self-extinguishing	ASTM D 635
Tensile Strength, yield, PSI	8500 minimum	ASTM D 638
Izod impact strength, ft-lb/in [notched, 1/8 inch]	12 minimum	ASTM D 256

For pole mounting, provide side of pole mounting assemblies with framework and all other hardware necessary to make complete, watertight connections of the signal heads to the poles and pedestals. Fabricate the mounting assemblies and frames from aluminum with all necessary hardware, screws, washers, etc. to be stainless steel. Provide mounting fittings that match the positive locking device on the signal head with the serrations integrally cast into the brackets. Provide upper and lower pole plates that have a 1 ¼-inch vertical conduit entrance hubs with the hubs capped on the lower plate and 1 ½-inch horizontal hubs. Ensure that the assemblies provide rigid attachments to poles and pedestals so as to allow no twisting or swaying of the signal heads. Ensure that all raceways are free of sharp edges and protrusions and can accommodate a minimum of ten Number 14 AWG conductors.

For pedestal mounting, provide a post-top slipfitter mounting assembly that matches the positive locking device on the signal head with serrations integrally cast into the slipfitter. Provide stainless steel hardware, screws, washers, etc. Provide a minimum of six 3/8 X 3/4-inch long square head bolts for attachment to pedestal. Provide a center post for multi-way slipfitters.

For light emitting diode (LED) traffic signal modules, provide the following requirements for inclusion on the Department's Qualified Products List for traffic signal equipment.

1. Sample submittal,
2. Third-party independent laboratory testing results for each submitted module with evidence of testing and conformance with all of the Design Qualification Testing specified in section 6.4 of each of the following Institute of Transportation Engineers (ITE) specifications:
 - Vehicle Traffic Control Signal Heads – Light Emitting Diode (LED) Circular Signal Supplement
 - Vehicle Traffic Control Signal Heads – Light Emitting Diode (LED) Vehicle Arrow Traffic Signal Supplement
 - Pedestrian Traffic Control Signal Indications –Light Emitting Diode (LED) Signal Modules.

(Note: The Department currently recognizes two approved independent testing laboratories. They are Intertek ETL Semko and Light Metrics, Incorporated with Garwood Laboratories. Independent laboratory tests from other laboratories may be considered as part of the QPL submittal at the discretion of the Department,

3. Evidence of conformance with the requirements of these specifications,
4. A manufacturer's warranty statement in accordance with the required warranty, and
5. Submittal of manufacturer's design and production documentation for the model, including but not limited to, electrical schematics, electronic component values, proprietary part numbers, bill of materials, and production electrical and photometric test parameters.

6. Evidence of approval of the product to bear the Intertek ETL Verified product label for LED traffic signal modules.

In addition to meeting the performance requirements for the minimum period of 60 months, provide a written warranty against defects in materials and workmanship for the modules for a period of 60 months after installation of the modules. During the warranty period, the manufacturer must provide new replacement modules within 45 days of receipt of modules that have failed at no cost to the State. Repaired or refurbished modules may not be used to fulfill the manufacturer's warranty obligations. Provide manufacturer's warranty documentation to the Department during evaluation of product for inclusion on Qualified Products List (QPL).

B. Vehicle Signal Heads:

Comply with the ITE standard "Vehicle Traffic Control Signal Heads". Provide housings with provisions for attaching backplates.

Provide visors that are 10 inches in length for 12-inch vehicle signal heads.

Provide a termination block with one empty terminal for field wiring for each indication plus one empty terminal for the neutral conductor. Have all signal sections wired to the termination block. Provide barriers between the terminals that have terminal screws with a minimum Number 8 thread size and that will accommodate and secure spade lugs sized for a Number 10 terminal screw.

Mount termination blocks in the yellow signal head sections on all in-line vehicle signal heads. Mount the termination block in the red section on five-section vehicle signal heads.

Furnish vehicle signal head interconnecting brackets. Provide one-piece aluminum brackets less than 4.5 inches in height and with no threaded pipe connections. Provide hand holes on the bottom of the brackets to aid in installing wires to the signal heads. Lower brackets that carry no wires and are used only for connecting the bottom signal sections together may be flat in construction.

For messenger cable mounting, provide messenger cable hangers, wire outlet bodies, balance adjusters, bottom caps, wire entrance fitting brackets, and all other hardware necessary to make complete, watertight connections of the vehicle signal heads to the messenger cable. Fabricate messenger cable hanger components, wire outlet bodies and balance adjuster components from stainless steel or malleable iron galvanized in accordance with ASTM A153 (Class A) or ASTM A123. Provide serrated rings made of aluminum. Provide messenger cable hangers with U-bolt clamps. Fabricate washers, screws, hex-head bolts and associated nuts, clevis pins, cotter pins, U-bolt clamps and nuts from stainless steel.

Provide LED vehicular traffic signal modules (hereafter referred to as modules) that consist of an assembly that uses LEDs as the light source in lieu of an incandescent lamp for use in traffic signal sections. Use LEDs that are aluminum indium gallium phosphorus (AlInGaP) technology for red and yellow indications and indium gallium nitride (InGaN) for green indications. Install the ultra bright type LEDs that are rated for 100,000 hours of continuous operation from -40°F to +165°F. Design modules to have a minimum useful life of 60 months and to meet all parameters of this specification during this period of useful life.

For the modules, provide spade terminals crimped to the lead wires and sized for a #10 screw connection to the existing terminal block in a standard signal head. Do not provide other types of crimped terminals with a spade adapter.

U-2714

TS-6

Wayne County

Ensure the power supply is integral to the module assembly. On the back of the module, permanently mark the date of manufacture (month & year) or some other method of identifying date of manufacture.

Tint the red, yellow and green lenses to correspond with the wavelength (chromaticity) of the LED. Transparent tinting films are unacceptable. Provide a lens that is integral to the unit with a smooth outer surface.

1. LED Circular Signal Modules:

Provide modules in the following configurations: 12-inch circular sections. All makes and models of LED modules purchased for use on the State Highway System shall appear on the current NCDOT Traffic Signal Qualified Products List (QPL).

Provide the manufacturer's model number and the product number (assigned by the Department) for each module that appears on the 2018 or most recent Qualified Products List. In addition, provide manufacturer's certification in accordance with Article 106-3 of the *Standard Specifications*, that each module meets or exceeds the ITE "Vehicle Traffic Control Signal Heads – Light Emitting Diode (LED) Circular Signal Supplement" dated June 27, 2005 (hereafter referred to as VTCSH Circular Supplement) and other requirements stated in this specification.

Provide modules that meet the following requirements when tested under the procedures outlined in the VTCSH Circular Supplement:

Module Type	Max. Wattage at 165° F	Nominal Wattage at 77° F
12-inch red circular	17	11
12-inch green circular	15	15

For yellow circular signal modules, provide modules tested under the procedures outlined in the VTCSH Circular Supplement to insure power required at 77° F is 22 Watts or less for the 12-inch circular module and 13 Watts or less for the 8-inch circular module.

Note: Use a wattmeter having an accuracy of $\pm 1\%$ to measure the nominal wattage and maximum wattage of a circular traffic signal module. Power may also be derived from voltage, current and power factor measurements.

2. LED Arrow Signal Modules

Provide 12-inch omnidirectional arrow signal modules. All makes and models of LED modules purchased for use on the State Highway System shall appear on the current NCDOT Traffic Signal Qualified Products List (QPL).

Provide the manufacturer's model number and the product number (assigned by the Department) for each module that appears on the 2018 or most recent Qualified Products List. In addition, provide manufacturer's certification in accordance with Article 106-3 of the *Standard Specifications*, that each module meets or exceeds the requirements for 12-inch omnidirectional modules specified in the ITE "Vehicle Traffic Control Signal Heads – Light Emitting Diode (LED) Vehicle Arrow Traffic Signal Supplement" dated July 1, 2007 (hereafter referred to as VTCSH Arrow Supplement) and other requirements stated in this specification.

Provide modules that meet the following requirements when tested under the procedures outlined in the VTCSH Arrow Supplement:

Module Type	Max. Wattage at 165° F	Nominal Wattage at 77° F
12-inch red arrow	12	9
12-inch green arrow	11	11

For yellow arrow signal modules, provide modules tested under the procedures outlined in the VTCSH Arrow Supplement to insure power required at 77° F is 12 Watts or less.

Note: Use a wattmeter having an accuracy of $\pm 1\%$ to measure the nominal wattage and maximum wattage of an arrow traffic signal module. Power may also be derived from voltage, current and power factor measurements.

C. Pedestrian Signal Heads:

Provide pedestrian signal heads with international symbols that meet the MUTCD. Do not provide letter indications.

Comply with the ITE standard for “Pedestrian Traffic Control Signal Indications” and the following sections of the ITE standard for “Vehicle Traffic Control Signal Heads” in effect on the date of advertisement:

- Section 3.00 - “Physical and Mechanical Requirements”
- Section 4.01 - “Housing, Door, and Visor: General”
- Section 4.04 - “Housing, Door, and Visor: Materials and Fabrication”
- Section 7.00 - “Exterior Finish”

Provide a double-row termination block with three empty terminals and number 10 screws for field wiring. Provide barriers between the terminals that accommodate a spade lug sized for number 10 terminal screws. Mount the termination block in the hand section. Wire all signal sections to the terminal block.

Where required by the plans, provide 16-inch pedestrian signal heads with traditional three-sided, rectangular visors, 6 inches long.

Provide 2-inch diameter pedestrian push-buttons with weather-tight housings fabricated from die-cast aluminum and threading in compliance with the NEC for rigid metal conduit. Provide a weep hole in the housing bottom and ensure that the unit is vandal resistant.

Provide push-button housings that are suitable for mounting on flat or curved surfaces and that will accept 1/2-inch conduit installed in the top. Provide units that have a heavy duty push-button assembly with a sturdy, momentary, normally-open switch. Have contacts that are electrically insulated from the housing and push-button. Ensure that the push-buttons are rated for a minimum of 5 mA at 24 volts DC and 250 mA at 12 volts AC.

Provide standard R10-3 signs with mounting hardware that comply with the MUTCD in effect on the date of advertisement. Provide R10-3E signs for countdown pedestrian heads and R10-3B for non-countdown pedestrian heads.

Design the LED pedestrian traffic signal modules (hereafter referred to as modules) for installation into standard pedestrian traffic signal sections that do not contain the incandescent signal section reflector, lens, eggcrate visor, gasket, or socket. Provide modules that consist of an assembly that uses LEDs as the light source in lieu of an incandescent lamp. Use LEDs that are of the latest aluminum

U-2714

TS-8

Wayne County

indium gallium phosphorus (AlInGaP) technology for the Portland Orange hand and countdown displays. Use LEDs that are of the latest indium gallium nitride (InGaN) technology for the Lunar White walking man displays. Install the ultra-bright type LEDs that are rated for 100,000 hours of continuous operation from -40°F to +165°F. Design modules to have a minimum useful life of 60 months and to meet all parameters of this specification during this period of useful life.

Design all modules to operate using a standard 3 - wire field installation. Provide spade terminals crimped to the lead wires and sized for a #10 screw connection to the existing terminal block in a standard pedestrian signal housing. Do not provide other types of crimped terminals with a spade adapter.

Ensure the power supply is integral to the module assembly. On the back of the module, permanently mark the date of manufacture (month & year) or some other method of identifying date of manufacture.

Provide modules in the following configuration: 16-inch displays which have the solid hand/walking man overlay on the left and the countdown on the right, and 12-inch displays which have the solid hand/walking man module as an overlay. All makes and models of LED modules purchased for use on the State Highway System shall appear on the current NCDOT Traffic Signal Qualified Products List (QPL).

Provide the manufacturer's model number and the product number (assigned by the Department) for each module that appears on the 2018 or most recent Qualified Products List. In addition, provide manufacturer's certification in accordance with Article 106-3 of the *Standard Specifications*, that each module meets or exceeds the ITE "Pedestrian Traffic Control Signal Indicators - Light Emitting Diode (LED) Signal Modules" dated August 04, 2010 (hereafter referred to as PTCSI Pedestrian Standard) and other requirements stated in this specification.

Provide modules that meet the following requirements when tested under the procedures outlined in the PTCSI Pedestrian Standard:

Module Type	Max. Wattage at 165° F	Nominal Wattage at 77° F
Hand Indication	16	13
Walking Man Indication	12	9
Countdown Indication	16	13

Note: Use a wattmeter having an accuracy of $\pm 1\%$ to measure the nominal wattage and maximum wattage of a circular traffic signal module. Power may also be derived from voltage, current and power factor measurements.

Provide module lens that is hard coated or otherwise made to comply with the material exposure and weathering effects requirements of the Society of Automotive Engineers (SAE) J576. Ensure all exposed components of the module are suitable for prolonged exposure to the environment, without appreciable degradation that would interfere with function or appearance.

Ensure the countdown display continuously monitors the traffic controller to automatically learn the pedestrian phase time and update for subsequent changes to the pedestrian phase time.

Ensure the countdown display begins normal operation upon the completion of the preemption sequence and no more than one pedestrian clearance cycle.

U-2714

TS-9

Wayne County

D. Signal Cable:

Furnish 16-4 and 16-7 signal cable that complies with IMSA specification 20-1 except provide the following conductor insulation colors:

- For 16-4 cable: white, yellow, red, and green
- For 16-7 cable: white, yellow, red, green, yellow with black stripe tracer, red with black stripe tracer, and green with black stripe tracer. Apply continuous stripe tracer on conductor insulation with a longitudinal or spiral pattern.

Provide a ripcord to allow the cable jacket to be opened without using a cutter. IMSA specification 19-1 will not be acceptable. Provide a cable jacket labeled with the IMSA specification number and provide conductors constructed of stranded copper.

3. CONTROLLERS WITH CABINETS**3.1.MATERIALS – GENERAL CABINETS**

Provide a moisture resistant coating on all circuit boards.

Provide one 20 mm diameter radial lead UL-recognized metal oxide varistor (MOV) between each load switch field terminal and equipment ground. Electrical performance is outlined below.

PROPERTIES OF MOV SURGE PROTECTOR	
Maximum Continuous Applied Voltage at 185° F	150 VAC (RMS) 200 VDC
Maximum Peak 8x20µs Current at 185° F	6500 A
Maximum Energy Rating at 185° F	80 J
Voltage Range 1 mA DC Test at 77° F	212-268 V
Max. Clamping Voltage 8x20µs, 100A at 77° F	395 V
Typical Capacitance (1 MHz) at 77° F	1600 pF

Provide a power line surge protector that is a two-stage device that will allow connection of the radio frequency interference filter between the stages of the device. Ensure that a maximum continuous current is at least 10A at 120V. Ensure that the device can withstand a minimum of 20 peak surge current occurrences at 20,000A for an 8x20 microsecond waveform. Provide a maximum clamp voltage of 395V at 20,000A with a nominal series inductance of 200µh. Ensure that the voltage does not exceed 395V. Provide devices that comply with the following:

Frequency (Hz)	Minimum Insertion Loss (dB)
60	0
10,000	30
50,000	55
100,000	50
500,000	50
2,000,000	60
5,000,000	40
10,000,000	20
20,000,000	25

3.2. MATERIALS – TYPE 170E CABINETS

A. Type 170 E Cabinets General:

Conform to the city of Los Angeles' Specification No. 54-053-08, *Traffic Signal Cabinet Assembly Specification* (dated July 2008), except as required herein.

Furnish model 332 base mounted cabinets configured for 8 vehicle phases, 4 pedestrian phases, and 6 overlaps. When overlaps are required, provide auxiliary output files for the overlaps. Do not reassign load switches to accommodate overlaps unless shown on electrical details.

Provide model 200 load switches, model 222 loop detector sensors, model 252 AC isolators, and model 242 DC isolators according to the electrical details. As a minimum, provide one (1) model 2018 conflict monitor, one (1) model 206L power supply unit, two (2) model 204 flashers, one (1) DC isolator (located in slot I14), and four (4) model 430 flash transfer relays (provide seven (7) model 430 flash transfer relays if auxiliary output file is installed) with each cabinet.

B. Type 170 E Cabinet Electrical Requirements:

Provide a cabinet assembly designed to ensure that upon leaving any cabinet switch or conflict monitor initiated flashing operation, the controller starts up in the programmed start up phases and start up interval.

Furnish two sets of non-fading cabinet wiring diagrams and schematics in a paper envelope or container and placed in the cabinet drawer.

All AC+ power is subject to radio frequency signal suppression.

Provide surge suppression in the cabinet for each type of cabinet device. Provide surge protection for the full capacity of the cabinet input file. Provide surge suppression devices that operate properly over a temperature range of -40° F to +185° F. Ensure the surge suppression devices provide both common and differential modes of protection.

Provide a pluggable power line surge protector that is installed on the back of the PDA (power distribution assembly) chassis to filter and absorb power line noise and switching transients. Ensure

U-2714**TS-11****Wayne County**

the device incorporates LEDs for failure indication and provides a dry relay contact closure for the purpose of remote sensing. Ensure the device meets the following specifications:

Peak Surge Current (Single pulse, 8x20 μ s).....	20,000A
Occurrences (8x20 μ s waveform).....	10 minimum @ 20,000A
Maximum Clamp Voltage.....	395VAC
Operating Current.....	15 amps
Response Time.....	< 5 nanoseconds

Provide a loop surge suppressor for each set of loop terminals in the cabinet. Ensure the device meets the following specifications:

Peak Surge Current (6 times, 8x20 μ s)	
(Differential Mode).....	400A
(Common Mode).....	1,000A
Occurrences (8x20 μ s waveform).....	500 min @ 200A
Maximum Clamp Voltage	
(Differential Mode @400A).....	35V
(Common Mode @1,000A).....	35V
Response Time.....	< 5 nanoseconds
Maximum Capacitance.....	35 pF

Provide a data communications surge suppressor for each communications line entering or leaving the cabinet. Ensure the device meets the following specifications:

Peak Surge Current (Single pulse, 8x20 μ s).....	10,000A
Occurrences (8x20 μ s waveform).....	100 min @ 2,000A
Maximum Clamp Voltage.....	Rated for equipment protected
Response Time.....	< 1 nanosecond
Maximum Capacitance.....	1,500 pF
Maximum Series Resistance.....	15 Ω

Provide a DC signal surge suppressor for each DC input channel in the cabinet. Ensure the device meets the following specifications:

Peak Surge Current (Single pulse, 8x20µs).....10,000A
 Occurrences (8x20µs waveform).....100 @ 2,000A
 Maximum Clamp Voltage.....30V
 Response Time.....< 1 nanosecond

Provide a 120 VAC signal surge suppressor for each AC+ interconnect signal input. Ensure the device meets the following specifications:

Peak Surge Current (Single pulse, 8x20µs).....20,000A
 Maximum Clamp Voltage.....350VAC
 Response Time.....< 200 nanoseconds
 Discharge Voltage.....<200 Volts @ 1,000A
 Insulation Resistance.....≥100 MΩ

Provide conductors for surge protection wiring that are of sufficient size (ampacity) to withstand maximum overcurrents which could occur before protective device thresholds are attained and current flow is interrupted.

If additional surge protected power outlets are needed to accommodate fiber transceivers, modems, etc., install a UL listed, industrial, heavy-duty type power outlet strip with a minimum rating of 15 A / 125 VAC, 60 Hz. Provide a strip that has a minimum of 3 grounded outlets. Ensure the power outlet strip plugs into one of the controller unit receptacles located on the rear of the PDA. Ensure power outlet strip is mounted securely; provide strain relief if necessary.

Provide a door switch in the front and a door switch in the rear of the cabinet that will provide the controller unit with a Door Ajar alarm when either the front or the rear door is open. Ensure the door switches apply DC ground to the Input File when either the front door or the rear door is open.

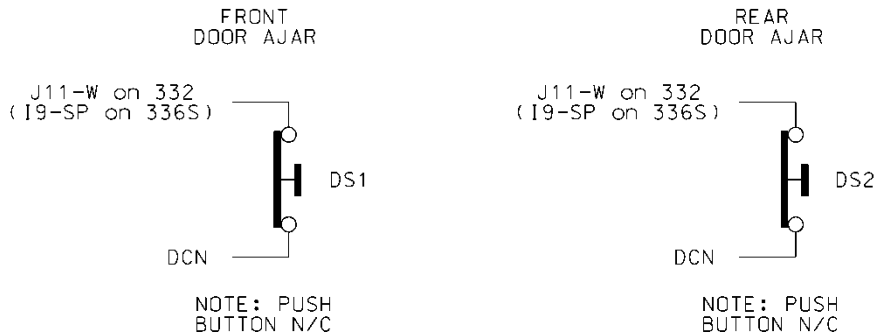

Furnish a fluorescent fixture in the rear across the top of the cabinet and another fluorescent fixture in the front across the top of the cabinet at a minimum. Ensure that the fixtures provide sufficient light to illuminate all terminals, labels, switches, and devices in the cabinet. Conveniently locate the fixtures

U-2714

TS-13

Wayne County

so as not to interfere with a technician's ability to perform work on any devices or terminals in the cabinet. Provide a protective diffuser to cover exposed bulbs. Install 16 watt T-4 lamps in the fluorescent fixtures. Provide a door switch to provide power to each fixture when the respective door is open. Wire the fluorescent fixtures to the 15 amp ECB (equipment circuit breaker).

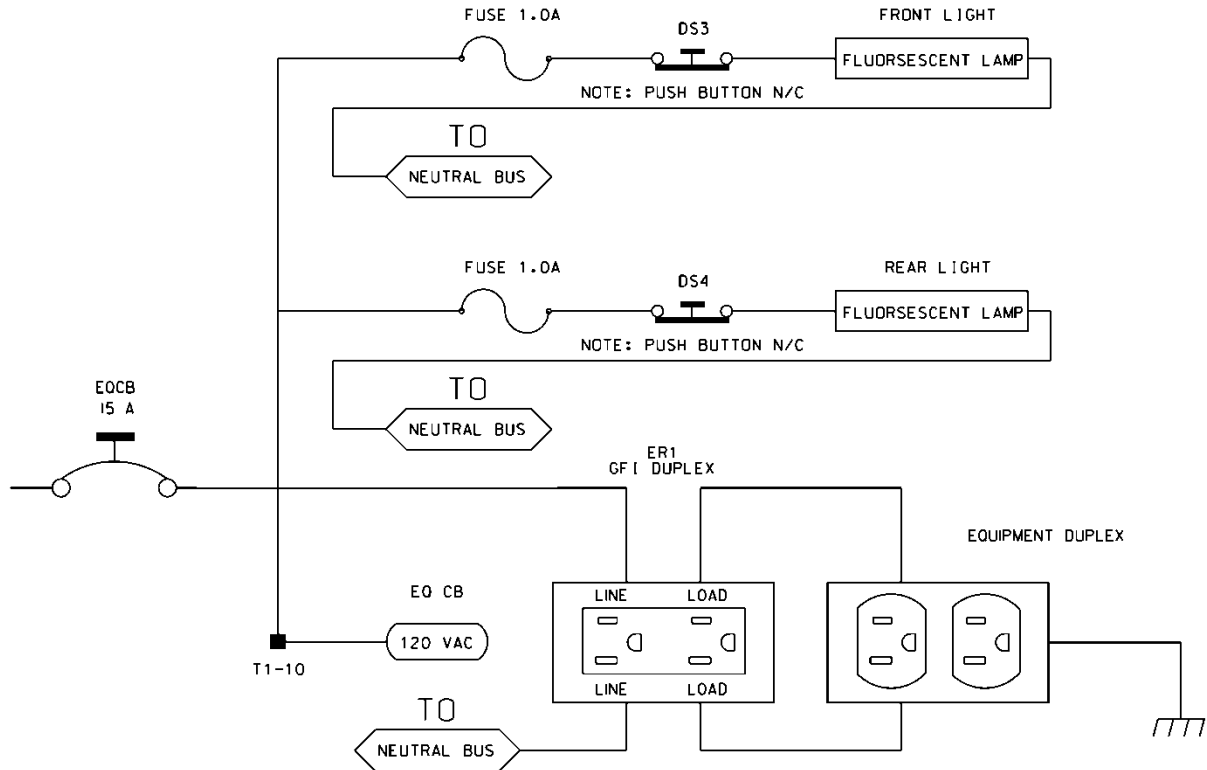

Furnish a police panel with a police panel door. Ensure that the police panel door permits access to the police panel when the main door is closed. Ensure that no rainwater can enter the cabinet even with the police panel door open. Provide a police panel door hinged on the right side as viewed from the front. Provide a police panel door lock that is keyed to a standard police/fire call box key. In addition to the requirements of LA Specification No. 54-053-08, provide the police panel with a toggle switch connected to switch the intersection operation between normal stop-and-go operation (AUTO) and manual operation (MANUAL). Ensure that manual control can be implemented using inputs and software such that the controller provides full programmed clearance times for the yellow clearance and red clearance for each phase while under manual control.

Provide a 1/4-inch locking phone jack in the police panel for a hand control to manually control the intersection. Provide sufficient room in the police panel for storage of a hand control and cord.

For model 332 base mounted cabinets, ensure terminals J14-E and J14-K are wired together on the rear of the Input File. Connect TB9-12 (J14 Common) on the Input Panel to T1-2 (AC-) on the rear of the PDA.

Provide detector test switches mounted at the top of the cabinet rack or other convenient location which may be used to place a call on each of eight phases based on the chart below. Provide three positions for each switch: On (place call), Off (normal detector operation), and Momentary On (place

U-2714**TS-14****Wayne County**

momentary call and return to normal detector operation after switch is released). Ensure that the switches are located such that the technician can read the controller display and observe the intersection.

Connect detector test switches for cabinets as follows:

332 Cabinet	
Detector Call Switches	Terminals
Phase 1	I1-W
Phase 2	I4-W
Phase 3	I5-W
Phase 4	I8-W
Phase 5	J1-W
Phase 6	J4-W
Phase 7	J5-W
Phase 8	J8-W

Provide the PCB 28/56 connector for the conflict monitor unit (CMU) with 28 independent contacts per side, dual-sided with 0.156 inch contact centers. Provide the PCB 28/56 connector contacts with solder eyelet terminations. Ensure all connections to the PCB 28/56 connector are soldered to the solder eyelet terminations.

Ensure that all cabinets have the CMU connector wired according to the 332 cabinet connector pin assignments (include all wires for auxiliary output file connection). Wire pins 13, 16, R, and U of the CMU connector to a separate 4 pin plug, P1, as shown below. Provide a second plug, P2, which will mate with P1 and is wired to the auxiliary output file as shown below. Provide an additional plug, P3, which will mate with P1 and is wired to the pedestrian yellow circuits as shown below. When no auxiliary output file is installed in the cabinet, provide wires for the green and yellow inputs for channels 11, 12, 17, and 18, the red inputs for channels 17 and 18, and the wires for the P2 plug. Terminate the two-foot wires with ring type lugs, insulated, and bundled for optional use.

PIN	P1		P2		P3	
	FUNCTION	CONN TO	FUNCTION	CONN TO	FUNCTION	CONN TO
1	CH-9G	CMU-13	OLA-GRN	A123	2P-YEL	114
2	CH-9Y	CMU-16	OLA-YEL	A122	4P-YEL	105
3	CH-10G	CMU-R	OLB-GRN	A126	6P-YEL	120
4	CH-10Y	CMU-U	OLB-YEL	A125	8P-YEL	111

Do not provide the P20 terminal assembly (red monitor board) or red interface ribbon cable as specified in LA Specification No. 54-053-08.

Provide a P20 connector that mates with and is compatible with the red interface connector mounted on the front of the conflict monitor. Ensure that the P20 connector and the red interface connector on the conflict monitor are center polarized to ensure proper connection. Ensure that removal of the P20 connector will cause the conflict monitor to recognize a latching fault condition and place the cabinet into flashing operation.

Wire the P20 connector to the output file and auxiliary output file using 22 AWG stranded wires. Ensure the length of these wires is a minimum of 42 inches in length. Provide a durable braided sleeve around the wires to organize and protect the wires.

Wire the P20 connector to the traffic signal red displays to provide inputs to the conflict monitor as shown below. Ensure the pedestrian Don't Walk circuits are wired to channels 13 through 16 of the P20 connector. When no auxiliary output file is installed in the cabinet, provide wires for channels 9 through 12 reds. Provide a wire for special function 1. Terminate the unused wires with ring type lugs, insulated, and bundled for optional use.

P20 Connector					
PIN	FUNCTION	CONN TO	PIN	FUNCTION	CONN TO
1	Channel 15 Red	119	2	Channel 16 Red	110
3	Channel 14 Red	104	4	Chassis GND	01-9
5	Channel 13 Red	113	6	N/C	
7	Channel 12 Red	AUX 101	8	Spec Function 1	
9	Channel 10 Red	AUX 124	10	Channel 11 Red	AUX 114
11	Channel 9 Red	AUX 121	12	Channel 8 Red	107
13	Channel 7 Red	122	14	Channel 6 Red	134
15	Channel 5 Red	131	16	Channel 4 Red	101
17	Channel 3 Red	116	18	Channel 2 Red	128
19	Channel 1 Red	125	20	Red Enable	01-14

Ensure the controller unit outputs to the auxiliary output file are pre-wired to the C5 connector. When no auxiliary output file is installed in the cabinet, connect the C5 connector to a storage socket located on the Input Panel or on the rear of the PDA.

Do not wire pin 12 of the load switch sockets.

In addition to the requirements of LA Specification No. 54-053-08, ensure relay K1 on the Power Distribution Assembly (PDA) is a four pole relay and K2 on the PDA is a two pole relay.

Provide a two pole, ganged circuit breaker for the flash bus circuit. Ensure the flash bus circuit breaker is an inverse time circuit breaker rated for 10 amps at 120 VAC with a minimum of 10,000 RMS symmetrical amperes short circuit current rating. Do not provide the auxiliary switch feature on the flash bus circuit breaker. Ensure the ganged flash bus circuit breaker is certified by the circuit breaker manufacturer to provide gang tripping operation.

U-2714

TS-16

Wayne County

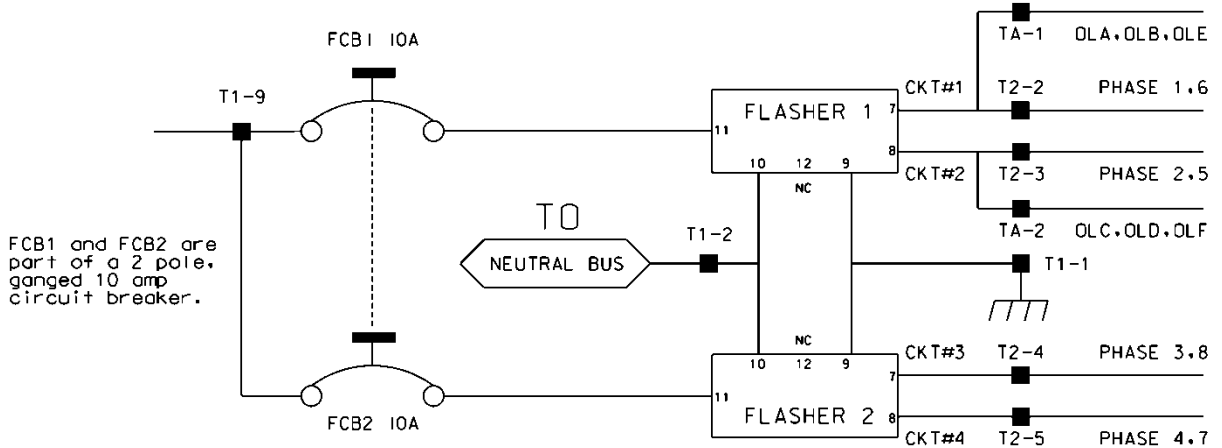

Ensure auxiliary output files are wired as follows:

AUXILIARY OUTPUT FILE	
TERMINAL BLOCK TA ASSIGNMENTS	
POSITION	FUNCTION
1	Flasher Unit #1, Circuit 1/FTR1 (OLA, OLB)/FTR3 (OLE)
2	Flasher Unit #1, Circuit 2/FTR2 (OLC, OLD)/FTR3 (OLF)
3	Flash Transfer Relay Coils
4	AC -
5	Power Circuit 5
6	Power Circuit 5
7	Equipment Ground Bus
8	NC

Provide four spare load resistors mounted in each cabinet. Ensure each load resistor is rated as shown in the table below. Wire one side of each load resistor to AC-. Connect the other side of each resistor to a separate terminal on a four (4) position terminal block. Mount the load resistors and terminal block either inside the back of Output File No. 1 or on the upper area of the Service Panel.

ACCEPTABLE LOAD RESISTOR VALUES	
VALUE (ohms)	WATTAGE
1.5K – 1.9 K	25W (min)
2.0K – 3.0K	10W (min)

Provide Model 200 load switches, Model 204 flashers, Model 242 DC isolators, Model 252 AC isolators, and Model 206L power supply units that conform to CALTRANS' *“Transportation Electrical Equipment Specifications”* dated March 12, 2009 with Erratum 1.

C. Type 170 E Cabinet Physical Requirements:

Do not mold, cast, or scribe the name “City of Los Angeles” on the outside of the cabinet door as specified in LA Specification No. 54-053-08. Do not provide a Communications Terminal Panel as specified in LA Specification No. 54-053-08. Do not provide terminal block TBB on the Service Panel. Do not provide Cabinet Verification Test Program software or associated test jigs as specified in LA Specification No. 54-053-08.

Furnish unpainted, natural, aluminum cabinet shells. Ensure that all non-aluminum hardware on the cabinet is stainless steel or a Department approved non-corrosive alternate.

Ensure the lifting eyes, gasket channels, police panel, and all supports welded to the enclosure and doors are fabricated from 0.125 inch minimum thickness aluminum sheet and meet the same standards as the cabinet and doors.

Provide front and rear doors with latching handles that allow padlocking in the closed position. Furnish 0.75 inch minimum diameter stainless steel handles with a minimum 0.5 inch shank. Place the padlocking attachment at 4.0 inches from the handle shank center to clear the lock and key. Provide an additional 4.0 inches minimum gripping length.

Provide Corbin #2 locks on the front and rear doors. Provide one (1) Corbin #2 and one (1) police master key with each cabinet. Ensure main door locks allow removal of keys in the locked position only.

Provide a surge protection panel with 16 loop surge protection devices and designed to allow sufficient free space for wire connection/disconnection and surge protection device replacement. For model 332 cabinets, provide an additional 20 loop surge protection devices. Provide an additional two AC+ interconnect surge devices to protect one slot and eight DC surge protection devices to protect four slots. Provide no protection devices on slot I14.

For base mounted cabinets, mount surge protection panels on the left side of the cabinet as viewed from the rear. Attach each panel to the cabinet rack assembly using bolts and make it easily removable. Mount the surge protection devices in vertical rows on each panel and connect the devices to one side of 12 position, double row terminal blocks with #8 screws. For each surge protection panel, terminate all grounds from the surge protection devices on a copper equipment ground bus attached to the surge protection panel. Wire the terminals to the rear of a standard input file using spade lugs for input file protection.

Provide permanent labels that indicate the slot and the pins connected to each terminal that may be viewed from the rear cabinet door. Label and orient terminals so that each pair of inputs is next to each other. Indicate on the labeling the input file (I or J), the slot number (1-14) and the terminal pins of the input slots (either D & E for upper or J & K for lower).

Provide a minimum 14 x 16 inch pull out, hinged top shelf located immediately below controller mounting section of the cabinet. Ensure the shelf is designed to fully expose the table surface outside the controller at a height approximately even with the bottom of the controller. Ensure the shelf has a storage bin interior which is a minimum of 1 inch deep and approximately the same dimensions as the shelf. Provide an access to the storage area by lifting the hinged top of the shelf. Fabricate the shelf and slide from aluminum or stainless steel and ensure the assembly can support the 2070L controller plus 15 pounds of additional weight. Ensure shelf has a locking mechanism to secure it in the fully extended position and does not inhibit the removal of the 2070L controller or removal of cards inside the controller when fully extended. Provide a locking mechanism that is easily released when the shelf is to be returned to its non-use position directly under the controller.

D. Model 2018 Enhanced Conflict Monitor:

Furnish Model 2018 Enhanced Conflict Monitors that provide monitoring of 18 channels. Ensure each channel consists of a green, yellow, and red field signal input. Ensure that the conflict monitor meets or exceeds CALTRANS' Transportation Electrical Equipment Specifications dated March 12, 2009, with Erratum 1 (hereafter referred to as CALTRANS' 2009 TEES) for a model 210 monitor unit and other requirements stated in this specification.

Ensure the conflict monitor is provided with an 18 channel conflict programming card. Pin EE and Pin T of the conflict programming card shall be connected together. Pin 16 of the conflict programming card shall be floating. Ensure that the absence of the conflict programming card will cause the conflict monitor to trigger (enter into fault mode), and remain in the triggered state until the programming card is properly inserted and the conflict monitor is reset.

Provide a conflict monitor that incorporates LED indicators into the front panel to dynamically display the status of the monitor under normal conditions and to provide a comprehensive review of field inputs with monitor status under fault conditions. Ensure that the monitor indicates the channels that were active during a conflict condition and the channels that experienced a failure for all other per channel fault conditions detected. Ensure that these indications and the status of each channel are retained until the Conflict Monitor is reset. Furnish LED indicators for the following:

- AC Power (Green LED indicator)
- VDC Failed (Red LED indicator)
- WDT Error (Red LED indicator)
- Conflict (Red LED indicator)
- Red Fail (Red LED indicator)
- Dual Indication (Red LED indicator)
- Yellow/Clearance Failure (Red LED indicator)
- PCA/PC Ajar (Red LED indicator)

- Monitor Fail/Diagnostic Failure (Red LED indicator)
- 54 Channel Status Indicators (1 Red, 1 Yellow, and 1 Green LED indicator for each of the 18 channels)

Provide a switch to set the Red Fail fault timing. Ensure that when the switch is in the ON position the Red Fail fault timing value is set to 1350 +/- 150 ms (2018 mode). Ensure that when the switch is in the OFF position the Red Fail fault timing value is set to 850 +/- 150 ms (210 mode).

Provide a switch to set the Watchdog fault timing. Ensure that when the switch is in the ON position the Watchdog fault timing value is set to 1.0 +/- 0.1 s (2018 mode). Ensure that when the switch is in the OFF position the Watchdog fault timing value is set to 1.5 +/- 0.1 s (210 mode).

Provide a jumper or switch to set the AC line brown-out levels. Ensure that when the jumper is present or the switch is in the ON position the AC line dropout voltage threshold is 98 +/- 2 Vrms, the AC line restore voltage threshold is 103 +/- 2 Vrms, and the AC line brown-out timing value is set to 400 +/- 50ms (2018 mode). Ensure that when the jumper is not present or the switch is in the OFF position the AC line dropout voltage threshold is 92 +/- 2 Vrms, the AC line restore voltage threshold is 98 +/- 2 Vrms, and the AC line brown-out timing value is set to 80 +/- 17 ms (210 mode).

Provide a jumper or switch that will enable and disable the Watchdog Latch function. Ensure that when the jumper is not present or the switch is in the OFF position the Watchdog Latch function is disabled. In this mode of operation, a Watchdog fault will be reset following a power loss, brownout, or power interruption. Ensure that when the jumper is present or the switch is in the ON position the Watchdog Latch function is enabled. In this mode of operation, a Watchdog fault will be retained until a Reset command is issued.

Provide a jumper that will reverse the active polarity for pin #EE (output relay common). Ensure that when the jumper is not present pin #EE (output relay common) will be considered 'Active' at a voltage greater than 70 Vrms and 'Not Active' at a voltage less than 50 Vrms (Caltrans mode). Ensure that when the jumper is present pin #EE (output relay common) will be considered 'Active' at a voltage less than 50 Vrms and 'Not Active' at a voltage greater than 70 Vrms (Failsafe mode).

In addition to the connectors required by CALTRANS' 2009 TEES, provide the conflict monitor with a red interface connector mounted on the front of the monitor. Ensure the connector is a 20 pin, right angle, center polarized, male connector with latching clip locks and polarizing keys. Ensure the right angle solder tails are designed for a 0.062" thick printed circuit board. Keying of the connector shall be between pins 3 and 5, and between 17 and 19. Ensure the connector has two rows of pins with the odd numbered pins on one row and the even pins on the other row. Ensure the connector pin row spacing is 0.10" and pitch is 0.10". Ensure the mating length of the connector pins is 0.24". Ensure the pins are finished with gold plating 30μ" thick.

U-2714

TS-20

Wayne County

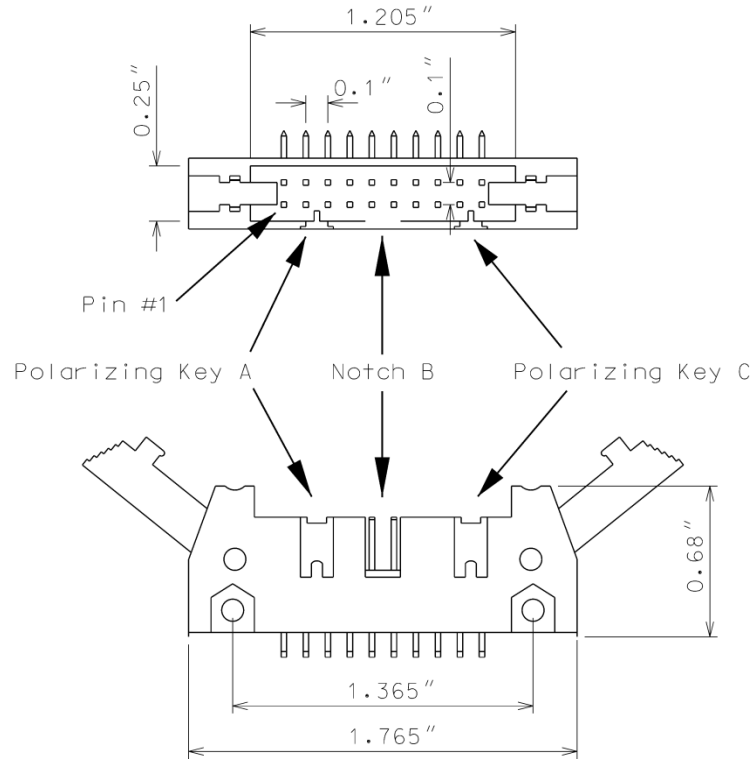

Ensure the red interface connector pins on the monitor have the following functions:

Pin #	Function	Pin #	Function
1	Channel 15 Red	2	Channel 16 Red
3	Channel 14 Red	4	Chassis Ground
5	Channel 13 Red	6	Special Function 2
7	Channel 12 Red	8	Special Function 1
9	Channel 10 Red	10	Channel 11 Red
11	Channel 9 Red	12	Channel 8 Red
13	Channel 7 Red	14	Channel 6 Red
15	Channel 5 Red	16	Channel 4 Red
17	Channel 3 Red	18	Channel 2 Red
19	Channel 1 Red	20	Red Enable

Ensure that removal of the P20 cable connector will cause the conflict monitor to recognize a latching fault condition and place the cabinet into flashing operation.

U-2714**TS-21****Wayne County**

Provide Special Function 1 and Special Function 2 inputs to the unit which shall disable only Red Fail Monitoring when either input is sensed active. A Special Function input shall be sensed active when the input voltage exceeds 70 Vrms with a minimum duration of 550 ms. A Special Function input shall be sensed not active when the input voltage is less than 50 Vrms or the duration is less than 250 ms. A Special Function input is undefined by these specifications and may or may not be sensed active when the input voltage is between 50 Vrms and 70 Vrms or the duration is between 250 ms and 550 ms.

Ensure the conflict monitor recognizes field signal inputs for each channel that meet the following requirements:

- consider a Red input greater than 70 Vrms and with a duration of at least 500 ms as an “on” condition;
- consider a Red input less than 50 Vrms or with a duration of less than 200 ms as an “off” condition (no valid signal);
- consider a Red input between 50 Vrms and 70 Vrms or with a duration between 200 ms and 500 ms to be undefined by these specifications;
- consider a Green or Yellow input greater than 25 Vrms and with a duration of at least 500 ms as an “on” condition;
- consider a Green or Yellow input less than 15 Vrms or with a duration of less than 200 ms as an “off” condition; and
- consider a Green or Yellow input between 15 Vrms and 25 Vrms or with a duration between 200 ms and 500 ms to be undefined by these specifications.

Provide a conflict monitor that recognizes the faults specified by CALTRANS’ 2009 TEES and the following additional faults. Ensure the conflict monitor will trigger upon detection of a fault and will remain in the triggered (in fault mode) state until the unit is reset at the front panel or through the external remote reset input for the following failures:

1. **Red Monitoring or Absence of Any Indication (Red Failure):** A condition in which no “on” voltage signal is detected on any of the green, yellow, or red inputs to a given monitor channel. If a signal is not detected on at least one input (R, Y, or G) of a conflict monitor channel for a period greater than 1000 ms when used with a 170 controller and 1500 ms when used with a 2070 controller, ensure monitor will trigger and put the intersection into flash. If the absence of any indication condition lasts less than 700 ms when used with a 170 controller and 1200 ms when used with a 2070 controller, ensure conflict monitor will not trigger. Red fail monitoring shall be enabled on a per channel basis by the use of switches located on the conflict monitor. Have red monitoring occur when all of the following input conditions are in effect:
 - a) Red Enable input to monitor is active (Red Enable voltages are “on” at greater than 70 Vrms, off at less than 50 Vrms, undefined between 50 and 70 Vrms), and
 - b) Neither Special Function 1 nor Special Function 2 inputs are active.
 - c) Pin #EE (output relay common) is not active

2. **Short/Missing Yellow Indication Fault (Clearance Error):** Yellow indication following a green is missing or shorter than 2.7 seconds (with ± 0.1 -second accuracy). If a channel fails to detect an “on” signal at the Yellow input for a minimum of 2.7 seconds (± 0.1 second) following the detection of an “on” signal at a Green input for that channel, ensure that the monitor triggers and generates a clearance/short yellow error fault indication. Short/missing yellow (clearance) monitoring shall be enabled on a per channel basis by the use of switches located on the conflict monitor. This fault shall not occur when the channel is programmed for Yellow Inhibit, when the Red Enable signal is inactive or pin #EE (output relay common) is active.
3. **Dual Indications on the Same Channel:** In this condition, more than one indication (R,Y,G) is detected as “on” at the same time on the same channel. If dual indications are detected for a period greater than 500 ms, ensure that the conflict monitor triggers and displays the proper failure indication (Dual Ind fault). If this condition is detected for less than 200 ms, ensure that the monitor does not trigger. G-Y-R dual indication monitoring shall be enabled on a per channel basis by the use of switches located on the conflict monitor. G-Y dual indication monitoring shall be enabled for all channels by use of a switch located on the conflict monitor. This fault shall not occur when the Red Enable signal is inactive or pin #EE (output relay common) is active.
4. **Configuration Settings Change:** The configuration settings are comprised of (as a minimum) the permissive diode matrix, dual indication switches, yellow disable jumpers, any option switches, any option jumpers, and the Watchdog Enable switch. Ensure the conflict monitor compares the current configuration settings with the previous stored configuration settings on power-up, on reset, and periodically during operation. If any of the configuration settings are changed, ensure that the conflict monitor triggers and causes the program card indicator to flash. Ensure that configuration change faults are only reset by depressing and holding the front panel reset button for a minimum of three seconds. Ensure the external remote reset input does not reset configuration change faults.

Ensure the conflict monitor will trigger and the AC Power indicator will flash at a rate of 2 Hz \pm 20% with a 50% duty cycle when the AC Line voltage falls below the “drop-out” level. Ensure the conflict monitor will resume normal operation when the AC Line voltage returns above the “restore” level. Ensure the AC Power indicator will remain illuminated when the AC voltage returns above the “restore” level. Should an AC Line power interruption occur while the monitor is in the fault mode, then upon restoration of AC Line power, the monitor will remain in the fault mode and the correct fault and channel indicators will be displayed.

Provide a flash interval of at least 6 seconds and at most 10 seconds in duration following a power-up, an AC Line interruption, or a brownout restore. Ensure the conflict monitor will suspend all fault monitoring functions, close the Output relay contacts, and flash the AC indicator at a rate of 4 Hz \pm 20% with a 50% duty cycle during this interval. Ensure the termination of the flash interval after at least 6 seconds if the Watchdog input has made 5 transitions between the True and False state and the AC Line voltage is greater than the “restore” level. If the watchdog input has not made 5 transitions

U-2714**TS-23****Wayne County**

between the True and False state within 10 ± 0.5 seconds, the monitor shall enter a WDT error fault condition.

Ensure the conflict monitor will monitor an intersection with a minimum of four approaches using the four-section Flashing Yellow Arrow (FYA) vehicle traffic signal as outlined by the NCHRP 3-54 research project for protected-permissive left turn signal displays. Ensure the conflict monitor will operate in the FYA mode and FYAc (Compact) mode as specified below to monitor each channel pair for the following fault conditions: Conflict, Flash Rate Detection, Red Fail, Dual Indication, and Clearance. Provide a switch to select between the FYA mode and FYAc mode. Provide a switch to select each FYA phase movement for monitoring.

FYA mode

FYA Signal Head	Phase 1	Phase 3	Phase 5	Phase 7
Red Arrow	Channel 9 Red	Channel 10 Red	Channel 11 Red	Channel 12 Red
Yellow Arrow	Channel 9 Yellow	Channel 10 Yellow	Channel 11 Yellow	Channel 12 Yellow
Flashing Yellow Arrow	Channel 9 Green	Channel 10 Green	Channel 11 Green	Channel 12 Green
Green Arrow	Channel 1 Green	Channel 3 Green	Channel 5 Green	Channel 7 Green

FYAc mode

FYA Signal Head	Phase 1	Phase 3	Phase 5	Phase 7
Red Arrow	Channel 1 Red	Channel 3 Red	Channel 5 Red	Channel 7 Red
Yellow Arrow	Channel 1 Yellow	Channel 3 Yellow	Channel 5 Yellow	Channel 7 Yellow
Flashing Yellow Arrow	Channel 1 Green	Channel 3 Green	Channel 5 Green	Channel 7 Green
Green Arrow	Channel 9 Green	Channel 9 Yellow	Channel 10 Green	Channel 10 Yellow

If a FYA channel pair is enabled for FYA operation, the conflict monitor will monitor the FYA logical channel pair for the additional following conditions:

1. **Conflict:** Channel conflicts are detected based on the permissive programming jumpers on the program card. This operation remains unchanged from normal operation except for the solid Yellow arrow (FYA clearance) signal.
2. **Yellow Change Interval Conflict:** During the Yellow change interval of the Permissive Turn channel (flashing Yellow arrow) the conflict monitor shall verify that no conflicting channels to the solid Yellow arrow channel (clearance) are active. These conflicting channels shall be determined by the program card compatibility programming of the Permissive Turn channel (flashing Yellow arrow). During the Yellow change interval of the Protected Turn channel (solid Green arrow) the conflict monitor shall verify that no conflicting channels to the solid Yellow arrow channel (clearance) are active as determined by the program card compatibility programming of the Protected Turn channel (solid Green arrow).
3. **Flash Rate Detection:** The conflict monitor unit shall monitor for the absence of a valid flash rate for the Permissive turn channel (flashing Yellow arrow). If the Permissive turn channel (flashing Yellow arrow) is active for a period greater than 1600 milliseconds, ensure the conflict monitor triggers and puts the intersection into flash. If the Permissive turn channel (flashing Yellow arrow) is active for a period less than 1400 milliseconds, ensure the conflict monitor does not trigger. Ensure the conflict monitor will remain in the triggered (in fault mode) state until the unit is reset at the front panel or through the external remote reset input. Provide a jumper or switch that will enable and disable the Flash Rate Detection function. Ensure that when the jumper is not present or the switch is in the OFF position the Flash Rate Detection function is enabled. Ensure that when the jumper is present or the switch is in the ON position the Flash Rate Detection function is disabled.
4. **Red Monitoring or Absence of Any Indication (Red Failure):** The conflict monitor unit shall detect a red failure if there is an absence of voltage on all four of the inputs of a FYA channel pair (RA, YA, FYA, GA).
5. **Dual Indications on the Same Channel:** The conflict monitor unit shall detect a dual indication if two or more inputs of a FYA channel pair (RA, YA, FYA, GA) are “on” at the same time.
6. **Short/Missing Yellow Indication Fault (Clearance Error):** The conflict monitor unit shall monitor the solid Yellow arrow for a clearance fault when terminating both the Protected Turn channel (solid Green arrow) interval and the Permissive Turn channel (flashing Yellow arrow) interval.

Ensure that the conflict monitor will log at least nine of the most recent events detected by the monitor in non-volatile EEPROM memory (or equivalent). For each event, record at a minimum the time, date, type of event, status of each field signal indication with RMS voltage, and specific channels involved with the event. Ensure the conflict monitor will log the following events: monitor reset, configuration, previous fault, and AC line. Furnish the signal sequence log that shows all channel states (Greens, Yellows, and Reds) and the Red Enable State for a minimum of 2 seconds prior to the current fault trigger point. Ensure the display resolution of the inputs for the signal sequence log is not greater than 50 ms.

For non-Ethernet connected monitors, provide a RS-232C/D compliant port (DB-9 female connector) on the front panel of the conflict monitor in order to provide communications from the conflict monitor to the 170/2070 controller or to a Department-furnished laptop computer. Electrically isolate the port interface electronics from all monitor electronics, excluding Chassis Ground. Ensure

U-2714**TS-25****Wayne County**

that the controller can receive all event log information through a controller Asynchronous Communications Interface Adapter (Type 170E) or Async Serial Comm Module (2070). Furnish and connect a serial cable from the conflict monitor's DB-9 connector to Comm Port 1 of the 2070 controller. Ensure conflict monitor communicates with the controller. Provide a Windows based graphic user interface software to communicate directly through the same monitor RS-232C/D compliant port to retrieve and view all event log information to a Department-furnished laptop computer. The RS-232C/D compliant port on the monitor shall allow the monitor to function as a DCE device with pin connections as follows:

Conflict Monitor RS-232C/D (DB-9 Female) Pinout		
Pin Number	Function	I/O
1	DCD	O
2	TX Data	O
3	RX Data	I
4	DTR	I
5	Ground	-
6	DSR	O
7	CTS	I
8	RTS	O
9	NC	-

U-2714

TS-26

Wayne County

MONITOR BOARD EDGE CONNECTOR

Pin #	Function (Back Side)	Pin #	Function (Component Side)
1	Channel 2 Green	A	Channel 2 Yellow
2	Channel 13 Green	B	Channel 6 Green
3	Channel 6 Yellow	C	Channel 15 Green
4	Channel 4 Green	D	Channel 4 Yellow
5	Channel 14 Green	E	Channel 8 Green
6	Channel 8 Yellow	F	Channel 16 Green
7	Channel 5 Green	H	Channel 5 Yellow
8	Channel 13 Yellow	J	Channel 1 Green
9	Channel 1 Yellow	K	Channel 15 Yellow
10	Channel 7 Green	L	Channel 7 Yellow
11	Channel 14 Yellow	M	Channel 3 Green
12	Channel 3 Yellow	N	Channel 16 Yellow
13	Channel 9 Green	P	Channel 17 Yellow
14	Channel 17 Green	R	Channel 10 Green
15	Channel 11 Yellow	S	Channel 11 Green
16	Channel 9 Yellow	T	Channel 18 Yellow
17	Channel 18 Green	U	Channel 10 Yellow
--		--	
18	Channel 12 Yellow	V	Channel 12 Green
19	Channel 17 Red	W	Channel 18 Red
20	Chassis Ground	X	Not Assigned
21	AC-	Y	DC Common
22	Watchdog Timer	Z	External Test Reset
23	+24VDC	AA	+24VDC
24	Tied to Pin 25	BB	Stop Time (Output)
25	Tied to Pin 24	CC	Not Assigned
26	Not Assigned	DD	Not Assigned
27	Relay Output, Side #3, N.O.	EE	Relay Output, Side #2, Common
28	Relay Output, Side #1, N.C.	FF	AC+

-- Slotted for keying between Pins 17/U and 18/V

U-2714

TS-27

Wayne County

CONFLICT PROGRAM CARD PIN ASSIGNMENTS

Pin #	Function (Back Side)	Pin #	Function (Component Side)
1	Channel 2 Green	A	Channel 1 Green
2	Channel 3 Green	B	Channel 2 Green
3	Channel 4 Green	C	Channel 3 Green
4	Channel 5 Green	D	Channel 4 Green
5	Channel 6 Green	E	Channel 5 Green
6	Channel 7 Green	F	Channel 6 Green
7	Channel 8 Green	H	Channel 7 Green
8	Channel 9 Green	J	Channel 8 Green
9	Channel 10 Green	K	Channel 9 Green
10	Channel 11 Green	L	Channel 10 Green
11	Channel 12 Green	M	Channel 11 Green
12	Channel 13 Green	N	Channel 12 Green
13	Channel 14 Green	P	Channel 13 Green
14	Channel 15 Green	R	Channel 14 Green
15	Channel 16 Green	S	Channel 15 Green
16	N/C	T	PC AJAR
17	Channel 1 Yellow	U	Channel 9 Yellow
18	Channel 2 Yellow	V	Channel 10 Yellow
19	Channel 3 Yellow	W	Channel 11 Yellow
20	Channel 4 Yellow	X	Channel 12 Yellow
21	Channel 5 Yellow	Y	Channel 13 Yellow
22	Channel 6 Yellow	Z	Channel 14 Yellow
23	Channel 7 Yellow	AA	Channel 15 Yellow
24	Channel 8 Yellow	BB	Channel 16 Yellow
--		--	
25	Channel 17 Green	CC	Channel 17 Yellow
26	Channel 18 Green	DD	Channel 18 Yellow
27	Channel 16 Green	EE	PC AJAR (Program Card)
28	Yellow Inhibit Common	FF	Channel 17 Green

-- Slotted for keying between Pins 24/BB and 25/CC

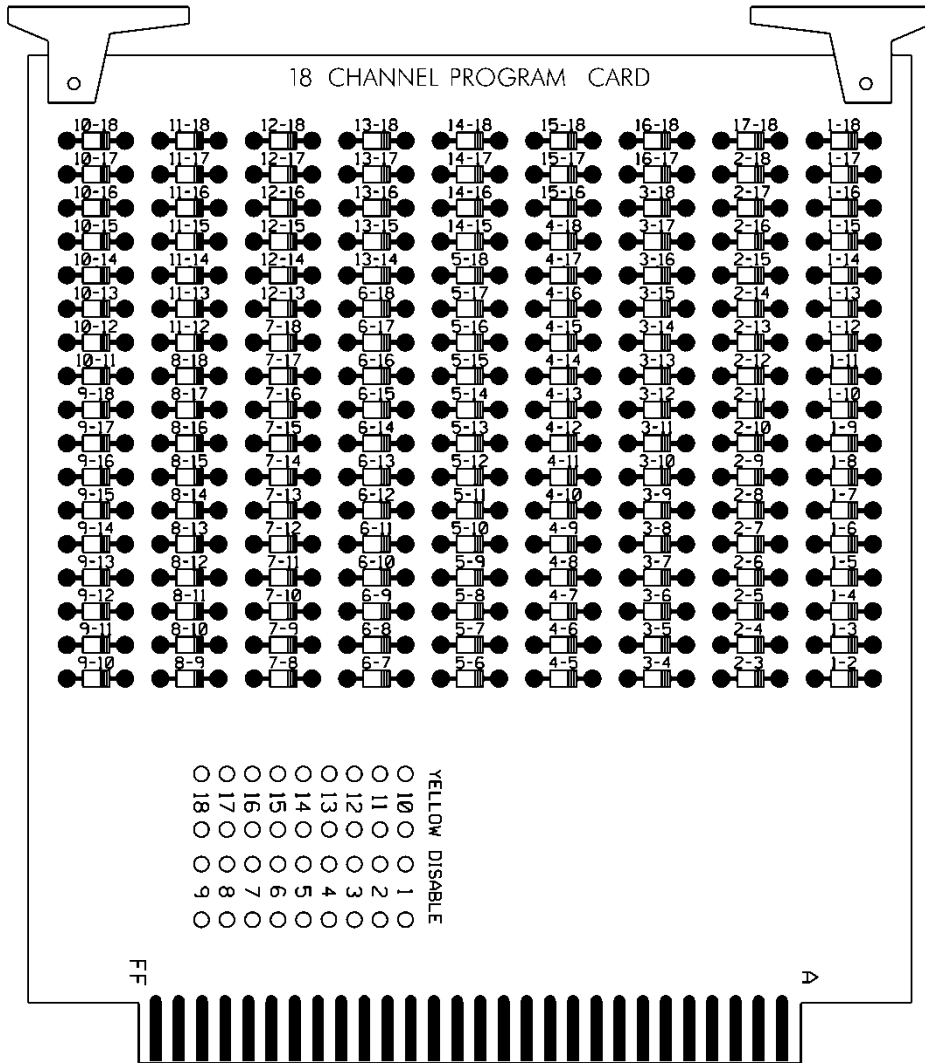

E. Preemption and Sign Control Box

Provide preemption and sign control box to operate in a Model 332 cabinet. Provide hardware to mount the box to the cage of the cabinet to ensure the front side is facing the opposite side of the cabinet. Furnish the material of the box from a durable finished metallic or thermoplastic case. Ensure the size of the box is not greater than 7(l) x 5(w) x 5(d) inches. Ensure that no modification is necessary to mount the box on the cabinet cage.

Provide the following components in the preemption and sign control box: relays, fuses, terminal blocks, MOVs, resistor, RC network, lamp, and push button switch.

Provide UL Listed or Recognized relay K1 as a DPDT enclosed relay (120 VAC, 60 Hz coil) with an 8-pin octal-style plug and associated octal base. Provide contact material made of AgCdO with a 10 amp, 240 VAC rating. Ensure the relay has a specified pickup voltage of 102 VAC.

Provide relay SSR1 as a Triac SPST normally open solid state relay that is rated for 120 VAC input and zero-crossing (resistive load) 25 amp @ 120 VAC output. Ensure the relay turns on at 90

U-2714

TS-29

Wayne County

Vrms within 10 ms and turns off at 10 Vrms within 40 ms. Ensure the relay has physical characteristics as shown in the wiring detail in Figure 1. Provide 4 terminal screws with saddle clamps.

Provide fuses F1 and F2 as a UL Listed ¼" x 1-1/4" glass tube rated at 250 volts with a 10kA interrupting rating. Ensure F1 non-delay (fast-acting) and F2 slow-blow (time-delay) fuses have a maximum opening times of 60 minutes and 120 seconds for currents of 135 and 200 percent of the ampere rating, respectively. Ensure F2 slow-blow (time-delay) fuses have a minimum opening times of 12 seconds at 200 percent of the ampere rating. Provide fuse holders that are UL Recognized panel-mounted holders rated 250V, 15 ampere minimum with bayonet-type knobs which accept ¼" x 1-1/4" glass tube fuses.

Provide terminal blocks that are rated for 300V and are made of electrical grade thermoplastic or thermosetting plastic. Ensure each terminal block is of closed back design and has recessed-screw terminals with molded barriers between terminals. Ensure each terminal block is labeled with a block designation. Ensure each terminal is labeled with the function and a number.

Provide 3/4-inch diameter radial lead UL-recognized metal oxide varistors (MOVs) that have electrical performance as outlined below.

PROPERTIES OF MOV SURGE PROTECTOR	
Maximum Continuous Applied Voltage at 185° F	150 VAC (RMS) 200 VDC
Maximum Peak 8x20µs Current at 185° F	6500 A
Maximum Energy Rating at 185° F	80 J
Voltage Range 1 mA DC Test at 77° F	212-268 V
Max. Clamping Voltage 8x20µs, 100A at 77° F	395 V
Typical Capacitance (1 MHz) at 77° F	1600 pF

Provide resistor R1 as a 2K ohm, 12 watt, wirewound resistor with tinned terminals and attaching leads. Ensure the resistor is spaced apart from surrounding wires.

Provide a LED or incandescent lamp that has a voltage rating of 120 VAC with a minimum life rating at 50,000 hours.

Wire the preemption and sign control box as shown in Figure 1.

3.3. MATERIALS – TYPE 170 DETECTOR SENSOR UNITS

Furnish detector sensor units that comply with Chapter 5 Section 1, “General Requirements,” and Chapter 5 Section 2, “Model 222 & 224 Loop Detector Sensor Unit Requirements,” of the CALTRANS “Transportation Electrical Equipment Specifications” dated March 12, 2009 with Erratum 1.

3.4. MATERIALS – TYPE 2070E CONTROLLERS

Furnish model 2070E controller units that conform to CALTRANS *Transportation Electrical Equipment Specifications* (TEES) (dated March 12, 2009, plus Errata 1 dated January 21, 2010 and Errata 2 dated December 5, 2014) except as required herein.

The Department will provide software at the beginning of the burning-in period. Contractor shall give 5 working days notice before needing software. Program software provided by the Department.

Provide model 2070E controllers with OS-9 release 1.3.1 or later with kernel edition #380 or later operating software and device drivers, composed of the unit chassis and at a minimum the following modules and assemblies:

- MODEL 2070-1E, CPU Module, Single Board, with 8Mb Datakey (blue in color)
- MODEL 2070-2E+, Field I/O Module (FI/O)
 - Note: Configure the Field I/O Module to disable both the External WDT Shunt/Toggle Switch and SP3 (SP3 active indicator is “off”)
- MODEL 2070-3B, Front Panel Module (FP), Display B (8x40)
- MODEL 2070-4A, Power Supply Module, 10 AMP
- MODEL 2070-7A, Async Serial Com Module (9-pin RS-232)

4. MICROWAVE VEHICLE DETECTION SYSTEM - MULTIPLE DETECTION ZONES

4.1. DESCRIPTION

Design, furnish and install a microwave vehicle detection system with the manufacturer recommended cables and hardware in accordance to the plans and specifications. Ensure the detection system provides multiple detection zones.

4.2. MATERIALS

Provide design drawings showing design details and microwave sensor locations for review and acceptance before installation. Provide mounting height and location requirements for microwave sensor units on the design based on a site survey. Design microwave vehicle detection system with all necessary hardware. Indicate all necessary poles, spans, luminaire arms, cables, microwave sensor mounting assemblies and hardware to achieve the required detection zones where Department owned poles are not adequate to locate the microwave sensor units. Do not design for the installation of poles in medians.

Obtain the Engineer’s approval before furnishing microwave vehicle detection system. The contractor is responsible for the final design of microwave vehicle detection system. Review and acceptance of the designs by the Department does not relieve the contractor from the responsibility to provide fully functional systems and to ensure that the required detection zones can be provided. With the exception of contractor-furnished poles, mast arms, and luminaire arms, furnish material, equipment, and hardware under this section that is pre-approved on the ITS and Signals QPL.

Submit and obtain Engineer's approval of shop drawings for any poles, mast arms, and luminaire arms provided by the contractor prior to ordering from manufacturer.

Provide a detector for either side-fire or forward-fire configuration. Ensure the detector will detect vehicles in sunny, cloudy, rainy, snowy, and foggy weather conditions. Ensure the detector can operate from the voltage supplied by a NEMA TS-1/TS-2 or Type 332 or 336 traffic signal cabinet. Ensure the detector can provide detection calls to the traffic signal controller within a NEMA TS-1/TS-2 or Type 332 or 336 cabinet. Ensure the detection system provides a constant call in the event of a component failure or loss of power. Ensure the detector has an operating temperature range of -30 to 165 degrees F and operates within the frequency range of 10 to 25 GHz. Ensure the detector is provided with a water-tight housing offering NEMA 4X protection and operates properly in up to 95% relative humidity, non-condensing.

Provide each detector unit to allow the placement of at least 8 detection zones with a minimum of 8 detection channel outputs. When the microwave vehicle detection system requires an integrated card rack interface(s), provide only enough interface cards to implement the vehicle detection shown on the signal plans. Provide a means acceptable to the Engineer to configure traffic lanes and detection zones. Provide each channel output with a programmable means to delay the output call upon activation of a detection zone that is adjustable in one second increments (maximum) over the range of 0 to 25 seconds. Provide each channel output with a programmable means to extend the output call that is adjustable in one second increments (maximum) over the range of 0 to 25 seconds. Ensure both delay and extend timing can be set for the same channel output.

For advance detection system, ensure the detector senses vehicles in motion at a range of 50 to 400 feet from the detector unit for forward-fire configuration and a range of 50 to 200 feet from the detector unit for side-fire configuration with an accuracy of 95% for both configurations. Ensure the advance detection system provides each channel output call of at least 100 ms in duration.

For stop bar presence detection system, ensure the detector outputs a constant call while a vehicle is in the detection zone and removes the call after all vehicles exit the detection zone. Ensure the presence detector unit can cover a detection zone as shown on the plans and has an effective range of 10 to 120 feet from the detector unit.

For units without an integrated card rack interface, provide Form C output relay contacts rated a minimum of 3A, 24VDC.

If a laptop is used to adjust detector settings, ensure that software is licensed for use by the Department and by any other agency responsible for maintaining or operating the microwave detection system. Provide the Department with a license to duplicate and distribute the software as necessary for design and maintenance support.

After initial detector configuration and installation, ensure routine adjustments or calibration are not needed to maintain acceptable performance.

4.3. CONSTRUCTION METHODS

Install the microwave vehicle detection system in accordance with the manufacturer's recommendations.

Monitor and maintain each detector unit during construction to ensure microwave vehicle detection system is functioning properly and aimed for the detection zone shown in the plans. Refer to Subarticle 1700-3 (D) Maintenance and Repair of Materials of the *Standard Specifications* for failure to maintain the microwave detection system.

4.4. MEASUREMENT AND PAYMENT

Actual number of microwave vehicle detection systems – multiple zones furnished, installed, and accepted.

No measurement will be made of cables or hardware, as these will be considered incidental to furnishing and installing microwave vehicle detection systems.

Payment will be made under:

Microwave Vehicle Detection System – Multiple Zones Each

5. TRAFFIC SIGNAL SUPPORTS

5.1. METAL TRAFFIC SIGNAL SUPPORTS – ALL POLES

A. General:

Furnish and install metal strain poles, grounding systems, and all necessary hardware. The work covered by this special provision includes requirements for the design, fabrication, and installation of both standard and custom/site specifically designed metal traffic signal supports and associated foundations.

Provide metal traffic signal support systems that contain no guy assemblies, struts, or stay braces. Provide designs of completed assemblies with hardware that equals or exceeds AASHTO *Standard Specifications for Structural Supports for Highway Signs, Luminaires and Traffic Signals* 6th Edition, 2013 (hereafter called 6th Edition AASHTO), including the latest interim specifications. Provide assemblies with a round or near-round (18 sides or more) cross-section, or a multi sided cross section with no less than six sides. The sides may be straight, convex, or concave.

Pole heights shown on signal plans are estimated from available data for bid purposes. Prior to furnishing metal signal poles, use field measurements and adjusted cross-sections to determine whether pole heights are sufficient to obtain required clearances. If pole heights are not sufficient, the Contractor should immediately notify the Engineer of the required revised pole heights.

Ensure that metal signal poles permit cables to be installed inside poles. For holes in the poles and arms used to accommodate cables, provide full-circumference grommets. Arm flange plate wire access holes should be deburred, non grommeted, and oversized to fit around the 2” diameter grommeted shaft flange plate wire access hole.

After fabrication, have steel poles and all parts used in the assembly hot-dip galvanized per section 1076. Design structural assemblies with weep holes large enough and properly located to drain molten zinc during the galvanization process. Provide hot-dip galvanizing on structures that meets or exceeds ASTM Standard A-123. Provide galvanizing on hardware that meets or exceeds ASTM Standard A-153. Ensure that threaded material is brushed and retapped as necessary after galvanizing. Perform repair of damaged galvanizing that complies with the following:

Repair of Galvanizing Article 1076-7

Standard Drawings for Metal Poles are available that supplement these project special provisions. These drawings are located on the Department’s website:

<https://connect.ncdot.gov/resources/safety/pages/ITS-Design-Resources.aspx>

U-2714

TS-34

Wayne County

Comply with article 1098-1B of the *2018 STANDARD SPECIFICATIONS FOR ROADS & STRUCTURES*, hereinafter referred to as the *Standard Specifications* for submittal requirements. Furnish shop drawings for approval. Provide the copies of detailed shop drawings for each type of structure as summarized below. Ensure that shop drawings include material specifications for each component and identify welds by type and size on the detail drawing only, not in table format. **Do not release structures for fabrication until shop drawings have been approved by NCDOT.** Provide an itemized bill of materials for all structural components and associated connecting hardware on the drawings.

Comply with article 1098-1A of the *Standard Specifications* for Qualified Products List (QPL) submittals. All shop drawings must include project location description, signal inventory number(s) and a project number or work order number on the drawings.

Summary of information required for metal pole review submittal:

Item	Hardcopy Submittal	Electronic Submittal	Comments / Special Instructions
Sealed, Approved Signal Plan/Loading Diagram	1	1	All structure design information needs to reflect the latest approved signal plans
Custom Pole Shop Drawings	4 sets	1 set	Show NCDOT inventory number(s), contractor's name and relevant revision number in the title block. All drawings must have a unique <u>drawing</u> number for each project and identified for multiple pages.
Standard Pole Shop Drawings (from the QPL)	4 sets	1 set	Submit drawings on 11" x 17" format media. Show NCDOT inventory number(s), contractor's name and relevant revision number in the title block. All drawings must have a <u>unique drawing</u> number for each project and identified for multiple pages.
Structure Calculations	1 set	1 set	Not required for Standard QPL Poles
Standard Pole Foundation Drawings	1 set	1 set	Submit drawings on 11" x 17" format media. Submit a completed Standard Foundation Selection form for each pole using foundation table on Metal Pole Drawing M-8.
Custom Foundation Drawings	4 sets	1 set	Submit drawings on 11" x 17" format media. Show NCDOT inventory number(s), contractor's name and relevant revision number in the title block. All drawings must have a <u>unique drawing</u> number for each project and identified for multiple pages. If QPL Poles are used, include the corresponding QPL pole shop drawings with this submittal.

U-2714

TS-35

Wayne County

Foundation Calculations	1	1	Submit copies of LPILE input, output and pile tip deflection graph per Section 11.4 of this specification for each foundation. Not required for Standard QPL Poles
Soil Boring Logs and Report	1	1	Report should include a location plan and a soil classification report including soil capacity, water level, hammer efficiency, soil bearing pressure, soil density, etc. for each pole.

NOTE – All shop drawings and custom foundation design drawings must be sealed by a Professional Engineer licensed in the state of North Carolina. All geotechnical information must be sealed by either a Professional Engineer or geologist licensed in the state of North Carolina. Include a title block and revision block on the shop drawings and foundation drawings showing the NCDOT inventory number.

Shop drawings and foundation drawings may be submitted together or separately for approval. However, shop drawings must be approved before foundations can be reviewed. Foundation designs will be returned without review if the associated shop drawing has not been approved. Boring reports should include the following: Engineer’s summary, boring location maps, soil classification per AASHTO Classification System, hammer efficiency, and Metal Pole Standard Foundation Selection Form. Incomplete submittals will be returned without review. The Reviewer has the right to request additional analysis and copies of the calculations to expedite the approval process.

B. Materials:

Fabricate metal pole and arm shaft from coil or plate steel to meet the requirements of ASTM A 595 Grade A tubes. For structural steel shapes, plates and bars use A572 Gr 50 min or ASTM A709 Gr 50 min. Provide pole and arm shafts that are round in cross section or multisided tubular shapes and have a uniform linear taper of 0.14 in/ft. Construct shafts from one piece of single ply plate or coil so there are no circumferential weld splices. Galvanize in accordance with AASHTO M 111 or an approved equivalent.

Use the submerged arc process or other NCDOT previously approved process suitable for pole shaft and arms to continuously weld pole shafts and arm shafts along their entire length. The longitudinal seam weld will be finished flush to the outside contour of the base metal. Ensure shafts have no circumferential welds except at the lower end joining the shaft to the pole base and arm base. Use full penetration groove welds with backing ring for all tube-to-transverse-plate connections in accordance with 6th Edition AASHTO. Provide welding that conforms to Article 1072-18 of the *Standard Specifications*, except that no field welding on any part of the pole will be permitted unless approved by a qualified engineer.

Refer to Metal Pole Standard Drawing Sheets M2 through M5 for fabrication details. Fabricate anchor bases and mast arm connecting plates from plate steel meeting, as a minimum, the requirements of ASTM A572 Gr 50, AASHTO M270 Gr 50, ASTM A709 Gr50, or an approved equivalent. Conform to the applicable bolt pattern and orientation as shown on Metal Pole Standard Drawing Sheet M2.

Ensure all hardware is galvanized steel or stainless steel. The Contractor is responsible for ensuring that the designer/fabricator specifies connecting hardware and/or materials that do not create a dissimilar metal corrosive reaction.

Provide a minimum of four (4) 1-1/2" diameter high strength bolts for connection between arm plate and pole plate. Increase number of bolts to six (6) 1-1/2" diameter high strength bolts when arm lengths are greater than 50'-0" long.

Unless otherwise required by the design, ensure each anchor rod is 2" diameter and 60" length. Provide 10" minimum thread projection at the top of the rod, and 8" minimum at the bottom of the rod. Use anchor rod assembly and drilled pier foundation materials that meet the *Foundations and Anchor Rod Assemblies for Metal Poles* provision.

For each structural bolt and other steel hardware, hot dip galvanizing shall conform to the requirements of AASHTO M 232 (ASTM A 153). Ensure end caps for poles are constructed of cast aluminum conforming to Aluminum Alloy 356.0F.

Provide a circular anchor bolt lock plate that will be secured to the anchor bolts at the embedded end with 2 washers and 2 nuts. Provide a base plate template that matches the bolt circle diameter of the anchor bolt lock plate. Construct plates and templates from 1/4" minimum thick steel with a minimum width of 4". Galvanizing is not required for both plates.

Provide 4 heavy hex nuts and 4 flat washers for each anchor bolt. For nuts, use AASHTO M291 grade 2H, DH, or DH3 or equivalent material. For flat washers, use AASHTO M293 or equivalent material.

C. Construction Methods:

Erect signal support poles only after concrete has attained a minimum allowable compressive strength of 3000 psi. Install anchor rod assemblies in accordance with the *Foundations and Anchor Rod Assemblies for Metal Poles* provision.

For further construction methods, see construction methods for Metal Strain Pole.

Connect poles to grounding electrodes and bond them to the electrical service grounding electrodes.

For holes in the poles used to accommodate cables, install grommets before wiring pole or arm. Do not cut or split grommets.

Attach the terminal compartment cover to the pole by a sturdy chain or cable. Ensure the chain or cable is long enough to permit the cover to hang clear of the compartment opening when the cover is removed, and is strong enough to prevent vandalism. Ensure the chain or cable will not interfere with service to the cables in the pole base.

Attach cap to pole with a sturdy chain or cable. Ensure the chain or cable is long enough to permit the cap to hang clear of the opening when the cap is removed.

Perform repair of damaged galvanizing that complies with the *Standard Specifications*, Article 1076-7 "Repair of Galvanizing."

Install galvanized wire mesh around the perimeter of the base plate to cover the gap between the base plate and top of foundation for debris and pest control.

Install a 1/4" thick plate for concrete foundation tag to include: concrete grade, depth, diameter, and reinforcement sizes of the installed foundation.

5.2. METAL POLE UPRIGHTS (VERTICAL MEMBERS)

A. Materials:

- Provide tapered tubular shafts and fabricated of steel conforming to ASTM A-595 Grade A or an approved equivalent.
- Hot-dip galvanize poles in accordance with AASHTO M 111 or an approved equivalent.
- Have shafts that are continuously welded for the entire length by the submerged arc process, and with exposed welds ground or rolled smooth and flush with the base metal. Provide welding that conforms to Article 1072-18 of the *Standard Specification* except that no field welding on any part of the pole will be permitted.
- Have Shafts with no circumferential welds except at the lower end joining the shaft to the base.
- Have anchor bases for steel poles fabricated from plate steel meeting as a minimum the requirements of ASTM A572 Gr 50, AASHTO M270 Gr 50, ASTM A709 Gr 50, or an approved equivalent.

Provide a grounding lug(s) in the approximate vicinity of the messenger cable clamp for bonding and grounding messenger cable. Lugs must accept #4 or #6 AWG wire to bond messenger cables to the pole in order to provide an effective ground fault circuit path. Refer to Metal Pole Standard Drawing Sheet M6 for construction details.

Have poles permanently stamped above the hand holes with the identification tag details as shown on Metal Pole Standard Drawing Sheet M2.

Provide liquid tight flexible metal conduit (Type LFMC), liquid tight flexible nonmetallic conduit (Type LFNC), high density polyethylene conduit (Type HDPE), or approved equivalent to isolate conductors feeding luminaires.

Fabricate poles from a single piece of steel or aluminum with single line seam weld with no transverse butt welds. Fabrication of two ply pole shafts is unacceptable with the exception of fluted shafts. Provide tapers for all shafts that begin at base and that have diameters which decrease uniformly at the rate of not more than 0.14 inch per foot (11.7 millimeters per meter) of length.

Provide four anchor nuts and four washers for each anchor bolt. Ensure that anchor bolts have required diameters, lengths, and positions, and will develop strengths comparable to their respective poles.

Provide a terminal compartment with cover and screws in each pole that encompasses the hand hole and contains a 12-terminal barrier type terminal block. Provide two terminal screws with a removable shorting bar between them for each termination. Furnish terminal compartment covers attached to the pole by a sturdy chain or cable approved by the Engineer. Ensure that the chain or cable is long enough to permit the cover to hang clear of the compartment opening when the cover is removed, and is strong enough to prevent vandals from being able to disconnect the cover from the pole. Ensure that the chain or cable will not interfere with service to the cables in the pole base.

Install grounding lugs that will accept #4 or #6 AWG wire to electrically bond messenger cables to the pole. Refer to Metal Pole Standard Drawing Sheet M6 for construction details.

For each pole, provide a 1/2 inch minimum thread diameter, coarse thread stud and nut for grounding which will accommodate #6 AWG ground wire. Ensure that the lug is electrically bonded to the pole and is conveniently located inside the pole at the hand hole.

Provide a removable pole cap with stainless steel attachment screws for the top of each pole. Ensure that the cap is cast aluminum conforming to Aluminum Association Alloy 356.0F. Furnish cap attached to the pole with a sturdy chain or cable approved by the Engineer. Ensure that the chain or cable is long enough to permit the cap to hang clear of the pole-top opening when the cap is removed.

When required by the plans, furnish couplings 42 inches above the bottom of the base for mounting of pedestrian pushbuttons. Provide mounting points consisting of 1-1/2 inch internally threaded half-couplings that comply with the NEC and that are mounted within the poles. Ensure that couplings are essentially flush with the outside surfaces of the poles and are installed before any required galvanizing. Provide a threaded plug in each mounting point. Ensure that the surface of the plug is essentially flush with the outer end of the mounting point when installed and has a recessed hole to accommodate a standard wrench.

1. STRAIN POLE SHAFTS

Provide 2 messenger cable (span wire) clamps and associated hardware for attachment of messenger cable. Ensure that diameter of the clamp is appropriate to its location on the pole and is appropriately designed to be adjustable from 1'-6" below the top, down to 6'-6" below the top of the pole. Do not attach more than one support cable to a messenger cable clamp.

Provide a minimum of three (3) 2 inch (50 mm) holes equipped with an associated coupling and weatherhead on the messenger cable load side of the pole to accommodate passage of signal cables from inside the pole. Provide galvanized threaded plugs for all unused couplings at pole entrance points. Refer to Metal Pole Standard Drawing Sheet M3 for fabrication details.

Ensure that allowable pole deflection does not exceed that allowed per 6th Edition AASHTO. Ensure maximum deflection at the top of the pole does not exceed 2.5 percent of the pole height.

B. Construction Methods:

Install metal poles, hardware, and fittings as shown on the manufacturer's installation drawings. Install metal poles so that when the pole is fully loaded it is within 1 degree 40 minutes (1°40') of vertical. Install poles with the manufacturer's recommended "rake." Use threaded leveling nuts to establish rake if required.

5.3. DRILLED PIER FOUNDATIONS FOR METAL TRAFFIC SIGNAL POLES

Analysis procedures and formulas shall be based on AASHTO 6th Edition, latest ACI code and the *Drilled Shafts: Construction Procedures and Design Methods* FHWA-NHI-10-016 manual. Design methods based on engineering publications or research papers needs to have prior approval from NCDOT. The Department reserves the right to accept or disapprove any method used for the analysis.

Use a Factor of Safety of 1.33 for torsion and 2.0 for bending for the foundation design.

Foundation design for lateral load shall not exceed 1" lateral deflection at top of foundation.

For lateral analysis, use LPILE Plus V6.0 or later. Inputs, results and corresponding graphs are to be submitted with the design calculations.

Skin Friction is to be calculated using the α -method for cohesive soils and the β -method for cohesion-less soils (**Broms method will not be accepted**). Detailed descriptions of the “ α ” and “ β ” methods can be found in *FHWA-NHI-10-016*.

Omit first 2.5ft for cohesive soils when calculating skin friction.

When hammer efficiency is not provided, assume a value of 0.70.

Design all custom foundations to carry the maximum capacity of each metal pole. For standard case strain poles only, if a custom foundation is designed, use the actual shear, axial and moment reactions from the Standard Foundation Selection Table shown on Standard Drawing No. M8.

When poor soil conditions are encountered which could create an excessively large foundation design, consideration may be given to allowing an exemption to the maximum capacity design. The contractor must gain approval from the engineer before reducing a foundation’s capacity. On projects where poor soil is known to be present, it is advisable that the contractor consider getting foundations approved before releasing poles for fabrication.

Have the contractor notify the engineer if the proposed foundation is to be installed on a slope other than 8H: 1V or flatter.

A. Description:

Furnish and install foundations for NCDOT metal poles with all necessary hardware in accordance with the plans and specifications.

Metal Pole Standards have been developed and implemented by NCDOT for use at signalized intersections in North Carolina. If the plans call for a standard pole, then a standard foundation may be selected from the plans. However, the Contractor is not required to use a standard foundation. If the Contractor chooses to design a non-standard site-specific foundation for a standard pole or if the plans call for a non-standard site-specific pole, design the foundation to conform to the applicable provisions in the NCDOT Metal Pole Standard Drawings and Section B7 (Non-Standard Foundation Design) below. If non-standard site specific foundations are designed for standard QPL approved strain poles, the foundation designer must use the design moment specified by load case on Metal Pole Standard Drawing Sheet M8. Failure to conform to this requirement will be grounds for rejection of the design.

If the Contractor chooses to design a non-standard foundation for a standard pole and the soil test results indicate a standard foundation is feasible for the site, the Contractor will be paid the cost of the standard foundation (drilled pier and wing wall, if applicable). Any additional costs associated with a non-standard site-specific foundation including additional materials, labor and equipment will be considered incidental to the cost of the standard foundation. All costs for the non-standard foundation design will also be considered incidental to the cost of the standard foundation.

B. Soil Test and Foundation Determination:

1. General:

Drilled piers are reinforced concrete sections, cast-in-place against in situ, undisturbed material. Drilled piers are of straight shaft type and vertical.

Some standard drilled piers for supporting poles with mast arms may require wing walls to resist torsional rotation. Based upon this provision and the results of the required soil test, a drilled pier length and wing wall requirement may be determined and constructed in accordance with the plans.

U-2714

TS-40

Wayne County

For non-standard site-specific poles, the contractor-selected pole fabricator will determine if the addition of wing walls is necessary for the supporting foundations.

2. Soil Test:

Perform a soil test at each proposed metal pole location. Complete all required fill placement and excavation at each signal pole location to finished grade before drilling each boring. Soil tests performed that are not in compliance with this requirement may be rejected and will not be paid. Drill one boring to a depth of 26 feet within a 25 foot radius of each proposed foundation.

Perform standard penetration tests (SPT) in accordance with ASTM D 1586 at depths of 1, 2.5, 5, 7.5, 10, 15, 20 and 26 feet. Discontinue the boring if one of the following occurs:

- A total of 100 blows have been applied in any 2 consecutive 6-in. intervals.
- A total of 50 blows have been applied with < 3-in. penetration.

Describe each intersection as the “Intersection of (Route or SR #), (Street Name) and (Route or SR #), (Street Name), _____ County, Signal Inventory No. _____”. Label borings with “B- N, S, E, W, NE, NW, SE or SW” corresponding to the quadrant location within the intersection. Pole numbers should be made available to the Drill Contractor. Include pole numbers in the boring label if they are available. If they are not available, ensure the boring labels can be cross-referenced to corresponding pole numbers. For each boring, submit a legible (hand written or typed) boring log signed and sealed by a licensed Geologist or Professional Engineer registered in North Carolina. Include on each boring the SPT blow counts and N-values at each depth, depth of the boring, hammer efficiency, depth of water table and a general description of the soil types encountered using the AASHTO Classification System.

3. Standard Foundation Determination:

Use the following method for determining the Design N-value:

$$N_{AVG} = \frac{(N@1' + N@2.5' + \dots + N@Deepest \text{ Boring Depth})}{\text{Total Number of N-values}}$$

$$Y = (N@1')^2 + (N@2.5')^2 + \dots + (N@Deepest \text{ Boring Depth})^2$$

$$Z = (N@1' + N@2.5' + \dots + N@Deepest \text{ Boring Depth})$$

$$N_{STD \text{ DEV}} = \left[\frac{(\text{Total Number of N-values} \times Y) - Z^2}{(\text{Total Number of N-values}) \times (\text{Total Number of N-values} - 1)} \right]^{0.5}$$

Design N-value equals lesser of the following two conditions:

$$N_{AVG} - (N_{STD \text{ DEV}} \times 0.45)$$

Or

$$\text{Average of First Four N-Values} = \frac{(N@1' + N@2.5' + N@5' + N@7.5')}{4}$$

Note: If less than 4 N-values are obtained because of criteria listed in Section 2 above, use average of N-values collected for second condition. Do not include the N-value at the deepest boring depth for above calculations if the boring is discontinued at or before the required boring depth because of criteria listed in Section 2 above. Use N-value of zero for weight of hammer or weight of rod. If N-value is greater than 50, reduce N-value to 50 for calculations.

If standard NCDOT strain poles are shown on the plans and the Contractor chooses to use standard foundations, determine a drilled pier length, "L," for each signal pole from the Standard Foundations Chart (sheet M 8) based on the Design N-value and the predominant soil type. For each standard pole location, submit a completed "Metal Pole Standard Foundation Selection Form" signed by the Contractor's representative. Signature on form is for verification purposes only. Include the Design N-value calculation and resulting drilled pier length, "L," on each form.

If non-standard site-specific poles are shown on the plans, submit completed boring logs collected in accordance with Section 2 (Soil Test) above along with pole loading diagrams from the plans to the contractor-selected pole fabricator to assist in the pole and foundation design.

If one of the following occurs, the Standard Foundations Chart shown on the plans may not be used and a non-standard foundation may be required. In such case, contact the Engineer.

- The Design N-value is less than 4.
- The drilled pier length, "L", determined from the Standard Foundations Chart, is greater than the depth of the corresponding boring.

In the case where a standard foundation cannot be used, the Department will be responsible for the additional cost of the non-standard foundation.

Foundation designs are based on level ground around the traffic signal pole. If the slope around the edge of the drilled pier is steeper than 8:1 (H:V) or the proposed foundation will be less than 10 feet from the top of an embankment slope, the Contractor is responsible for providing slope information to the foundation designer and to the Engineer so it can be considered in the design.

The "Metal Pole Standard Foundation Selection Form" may be found at:

<http://www.ncdot.gov/doh/preconstruct/highway/geotech/formdet/misc/MetalPole.pdf>

If assistance is needed, contact the Engineer.

4. Non-Standard Foundation Design:

Design non-standard foundations based upon site-specific soil test information collected in accordance with Section 2 (Soil Test) above. Design drilled piers for side resistance only in accordance with Section 4.6 of the *AASHTO Standard Specifications for Highway Bridges*. Use the computer software LPILE version-6.0 or later manufactured by Ensoft, Inc. to analyze drilled piers. Use the computer software gINT V8i or later manufactured by Bentley Systems, Inc. with the current NCDOT gINT library and data template to produce SPT boring logs. Provide a drilled pier foundation for each pole with a length and diameter that result in a horizontal lateral movement of less than 1 inch at the top of the pier and a horizontal rotational movement of less than 1 inch at the edge of the pier. Contact the Engineer for pole loading diagrams for standard poles to be used for non-standard

U-2714

TS-42

Wayne County

foundation designs. Submit any non-standard foundation designs including drawings, calculations, and soil boring logs to the Engineer for review and approval before construction.

C. Drilled Pier Construction:

Construct drilled pier foundations in accordance with the *Foundations and Anchor Rod Assemblies for Metal Poles* provision.

5.4. POLE NUMBERING SYSTEM

A. New Poles

Attach an identification tag to each pole shaft as shown on Metal Pole Standard Drawing Sheet M2 "Typical Fabrication Details Common To All Metal Poles".

5.5. MEASUREMENT AND PAYMENT

Actual number of metal strain signal poles (without regard to height or load capacity) furnished, installed and accepted.

Actual number of soil tests with SPT borings drilled furnished and accepted.

Actual volume of concrete poured in cubic yards of drilled pier foundation furnished, installed and accepted.

No measurement will be made for foundation designs prepared with metal pole designs, as these will be considered incidental to designing signal support structures.

Payment will be made under:

Metal Strain Signal Pole.....	Each
Soil Test.....	Each
Drilled Pier Foundation.....	Cubic Yard

U-2714

ST-1

Wayne County

**Project Special Provisions
Structure**

Table of Contents

Description	Page No.
Optional Precast Reinforced Concrete Box Culvert at Station 75+49.09 -L-	(12-12-13).....ST-2
Falsework and Formwork	(4-5-12).....ST-10
Submittal of Working Drawings	(6-28-17)..... ST-17
Crane Safety	(6-20-19).....ST-23
Grout for Structures	(12-1-17).....ST-24



DocuSigned by: *Tyler K. Andrews* 01/21/2020
 CEBD93F637E94FB...

U-2714

ST-2

Wayne County

**OPTIONAL PRECAST REINFORCED CONCRETE
BOX CULVERT AT STATION 75+49.09 -L-**

(12-12-13)

1.0 GENERAL

This Special Provision covers the design, fabrication and construction of precast reinforced concrete box culverts intended for the conveyance of storm water.

If the option is indicated on the plans, the submittal for a precast reinforced box culvert in lieu of a cast-in-place culvert is permitted. Design the precast culvert sections in accordance with ASTM C1577 or the current edition of the AASHTO LRFD Bridge Design Specifications. Rate all sizes of precast reinforced concrete box culverts in accordance with the current edition of the AASHTO Manual for Bridge Evaluation. Ensure the culvert rates for the AASHTO design loads and North Carolina's legal loads (see Section 2.0 for North Carolina's legal loads). Provide the size and number of barrels as indicated on the plans. Detail the culvert with cast-in-place wings walls and footings. Precast wing walls and footings will not be allowed. Provide a precast box culvert that meets the requirements of Section 1077 and any other applicable parts of the Standard Specifications.

The design and rating of the precast and cast-in-place members is the responsibility of the Contractor and is subject to review, comments and approval. Submit two sets of detailed plans and rating sheets for review. Include all details in the plans, including the size and spacing of the required reinforcement necessary to build the precast box and cast-in-place members. Have a North Carolina Registered Professional Engineer check and seal the plans, rating sheets and design calculations. After the plans, rating sheets and design calculations are reviewed and, if necessary, the corrections made, submit one set of plans and rating sheets on 22" x 34" sheets to become part of the contract plans.

If the span, rise and design earth cover for the precast reinforced concrete box culvert are identical to a previously approved submittal, the Contractor may request the previously approved design calculations and plans be considered as the submittal for review and approval. However, a set of plans and rating sheets will need to be submitted to become part of the contract plans.

2.0 NORTH CAROLINA'S LEGAL LOADS

Apply the following legal loads to all structures carrying interstate traffic:

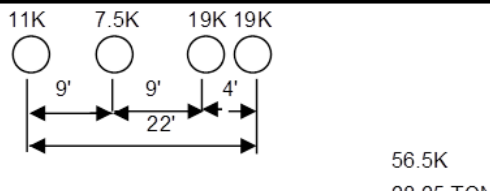
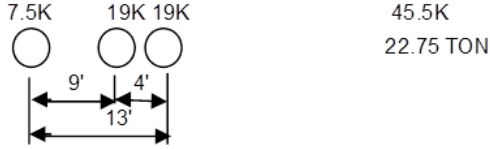
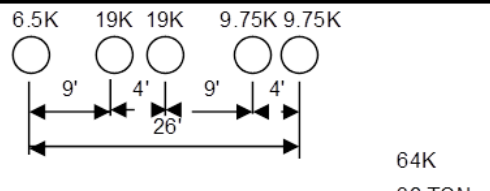
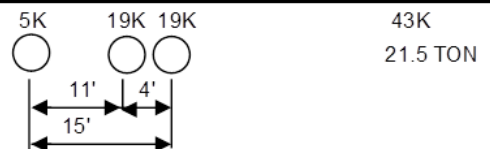
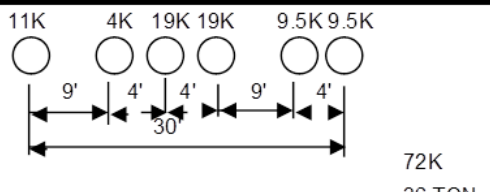
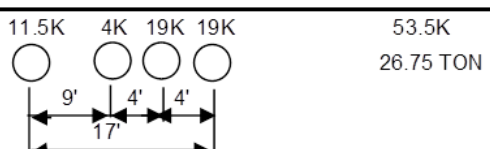
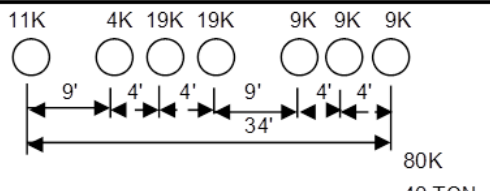
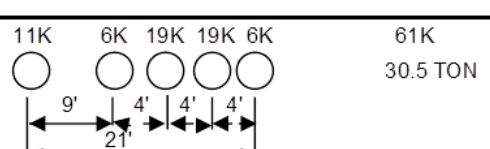
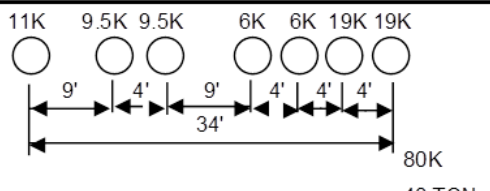
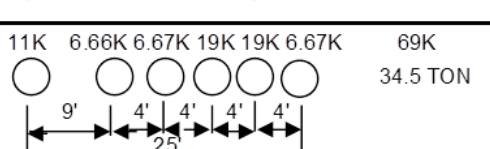
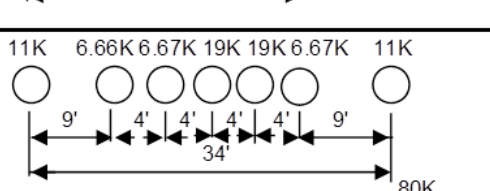
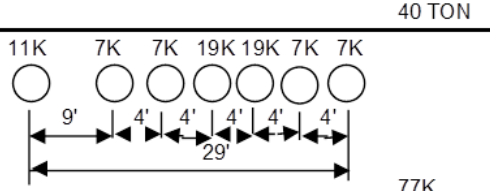
SINGLE VEHICLE(SV)		TRUCK TRACTOR SEMI-TRAILER(TTST)	
REF. #	SCHEMATIC	REF. #	SCHEMATIC
SH		T4A	
S3A		T5B	
S3C		T6A	
S4A		T7A	
S5A		T7B	
S6A			
S7A			
S7B			

U-2714

ST-4

Wayne County

Apply the following legal loads to all structures carrying non-interstate traffic:

SINGLE VEHICLE (SV)			TRUCK TRACTOR SEMI-TRAILER (TTST)		
REF. #	SCHEMATIC		REF. #	SCHEMATIC	
SNSH	5K ○ 14' ○	22K ○ 27K 13.5 TON	TNAGRIT3	22K 22K 22K ○ ○ ○ 9' 9' 18' 66K 33 Ton	
SNGARBS2	23.5K ○ 14' ○	16.5K ○ 40K 20 TON	TNT4A	12.1K 12.05K 21K 21K ○ ○ ○ ○ 9' 9' 4' 22' 66.15K 33.075 TON	
SNAGRIS2	22K ○ 14' ○	22K ○ 44K 22 Ton	TNAGRIT4	22K 22K 21K 21K ○ ○ ○ ○ 9' 9' 4' 22' 86K 43 TON	
SNCOTTS3	4.5K 25K 25K ○ ○ ○ 11' 4' 15'	54.5K 27.25 TON	TNAGT5A	22K 21K 21K 13K 13K ○ ○ ○ ○ ○ 9' 4' 9' 4' 26' 90K 45 TON	
SNAGGRS4	16K 15.85K 19K 19K ○ ○ ○ ○ 9' 4' 4' 17'	69.85K 34.925 TON	TNAGT5B	6K 21K 21K 21K 21K ○ ○ ○ ○ ○ 9' 4' 9' 4' 26' 90K 45 TON	
SNS5A	12.1K 8.5K 21K 21K 8.5K ○ ○ ○ ○ ○ 9' 4' 4' 4' 21'	71.1K 35.55 TON	TNT6A	12.1K 8.2K 21K 21K 10.45K 10.45K ○ ○ ○ ○ ○ ○ 9' 4' 4' 9' 4' 30' 83.2K 41.6 TON	
SNS6A	12.1K 8.6K 8.6K 21K 21K 8.6K ○ ○ ○ ○ ○ ○ 9' 4' 4' 4' 4' 25'	79.9K 39.95 TON	TNT7A	4.1K 4K 21K 21K 11.3K 11.3K 11.3K ○ ○ ○ ○ ○ ○ ○ 9' 4' 4' 9' 4' 4' 34' 84K 42 TON	
SNS7B	7.6K 8.6K 8.6K 21K 21K 8.6K 8.6K ○ ○ ○ ○ ○ ○ ○ 9' 4' 4' 4' 4' 4' 29'	84K 42 TON	TNT7B	4.1K 10.5K 10.5K 8.45K 8.45K 21K 21K ○ ○ ○ ○ ○ ○ ○ 9' 4' 9' 4' 4' 4' 34' 84K 42 TON	

3.0 PRECAST REINFORCED CONCRETE BOX SECTIONS

The precast reinforced concrete box culvert sections shall match the size and hydraulic opening indicated in the contract plans.

A. Design

1. Design Fill – The design earth cover is reported on the plans as the elevation difference between the point of maximum fill and the bottom of the top slab.
2. Placement of Reinforcement – Provide a 1 inch concrete cover over the reinforcement subject to the provisions of Section F. Extend the inside reinforcement into the tongue portion of the joint and the outside reinforcement into the groove portion of the joint. Detail the clear distance of the end wires so it is not less than 1/2 inch or more than 2 inches from the ends of the box section. Assemble reinforcement per the requirements of ASTM C1577 or the approved design. The exposure of the ends of the wires used to position the reinforcement is not a cause for rejection.
3. Laps and Spacing – Use lap splices for the transverse reinforcement. Detail the transverse wires so that the center to center spacing is not less than 2 inches or more than 4 inches. Do not detail the longitudinal wires with a center to center spacing of more than 8 inches.

B. Joints

1. Produce the precast reinforced concrete box section with tongue and groove ends. Design and form these ends of the box section so, when the sections are laid together, they make a continuous line of box sections with a smooth interior free of appreciable irregularities in the flowline, all compatible with the permissible variations given in Section F. The internal joint formed at the tongue and groove ends of the precast units shall be sealed with either bitumen/butyl sealant or closed-cell neoprene material. The internal joint material shall be installed in accordance with the manufacturer's recommendations. The material shall be shown on the shop drawings when they are submitted for review.
2. Seal the external joint with an outside sealer wrap conforming to ASTM C877 that is at least 12 inches wide and covers the joint on both the sides and the top of the box section. Use ConWrap CS-212 from Concrete Sealants, Inc., EZ-Wrap from Press-Seal Gasket Corporation, Seal Wrap from Mar-Mac Manufacturing Co., Inc., Cadilloc External Pipe Joint from Cadilloc, or an approved equal for the outside sealer wrap. If the outside sealer wrap is not applied in a continuous strip along the entire joint, a 12 inch minimum lap of the outside sealer wrap is permitted. Before placing the outside sealer wrap, clean and prime the area receiving the outside sealer wrap in accordance with the sealer wrap manufacturer recommendations. The joint wrap manufacturer installation recommendations shall be included with shop drawings submitted for review. The external joint wrap shall be installed in pieces, as indicated on Figure 1 below:

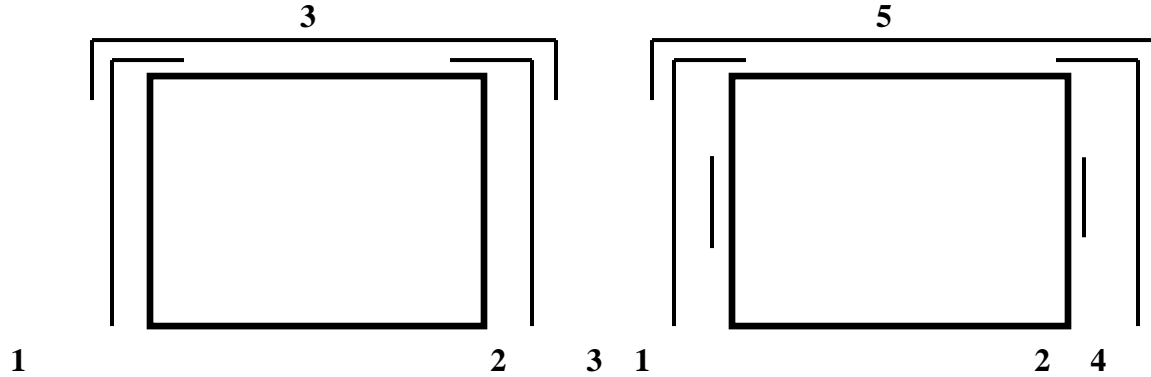

Figure 1

Cover the external joint sealer with a 3 foot strip of filter fabric conforming to Type 4 requirements in Section 1056 of the Standard Specifications.

Place multiple lines of a precast reinforced concrete box culvert such that the longitudinal joint between the sections has a minimum width of 3 inches. Fill the joint between multiple lines of precast box sections with Class A concrete. Use Class A concrete that meets the requirements listed in the Standard Specifications except that Field Compressive Strength Specimens are not required.

C. Manufacture

Manufacture precast reinforced concrete box culvert sections by either the wet cast method or dry cast method.

1. Mixture – In addition to the requirements of Section 1077 of the Standard Specifications, do not proportion the mix with less than 564 lb/yd³ of portland cement.
2. Strength – Concrete shall develop a minimum 28-day compressive strength of 5000 psi. Movement of the precast sections should be minimized during the initial curing period. Any damage caused by moving or handling during the initial curing phase will be grounds for rejection of that precast section.
3. Air Entrainment – Air entrain the concrete in accordance with Section 1077 - 5(A) of the Standard Specifications. For dry cast manufacturing, air entrainment is not required.
4. Testing – Test the concrete in accordance with the requirements of Section 1077 - 5(B).
5. Handling – Handling devices or holes are permitted in each box section for the purpose of handling and placing. Submit details of handling devices or holes for

U-2714**ST-7****Wayne County**

approval and do not cast any concrete until approval is granted. Remove all handling devices flush with concrete surfaces as directed. Fill holes in a neat and workmanlike manner with an approved non-metallic non-shrink grout, concrete, or hole plug.

D. Physical Requirements

Acceptability of precast culvert sections is based on concrete cylinders made and tested in accordance with ASTM C31 and ASTM C39.

E. Permissible Variations

1. Flatness – All external surfaces shall be flat, true, and plumb. Irregularities, depressions, or high spots on all external surfaces shall not exceed 1/2 inch in 8 feet.
2. Internal Dimensions – Produce sections so that the internal and haunch dimensions do not vary more than 1/4 inch from the plan dimensions.
3. Adjacent Sections - Internal, external, and haunch dimensions for connecting sections shall not vary more than 1/2 inch.
4. Length of Tongue and Groove – The minimum length of the tongue shall be 4 inches. The minimum length of the groove shall be 4 inches. The dimensions of the tongue and groove shall not vary more than 1/4 inch from the plan dimensions.
5. Slab and Wall Thickness – Produce sections so that the slab and wall thickness are not less than that shown on the plans by more than 5% or 3/16 inch, whichever is greater. A thickness more than that required on the plans is not a cause for rejection.
6. Length of Opposite Surfaces – Produce sections so that variations in laying lengths of two opposite surfaces of the box section meet the requirements of ASTM C1577, Section 11.3.
7. Length of Section – Produce sections so that the underrun in length of a section is not more than 1/2 inch in any box section.
8. Position of Reinforcement – Produce sections so that the maximum variation in the position of the reinforcement is $\pm 3/8$ inch for slab and wall thicknesses of 5 inches or less and $\pm 1/2$ inch for slab and wall thicknesses greater than 5 inches. Produce sections so that the concrete cover is never less than 5/8 inch as measured to the internal surface or the external surface. The preceding minimum cover limitations do not apply at the mating surfaces of the joint.
9. Area of Reinforcement – Use the design steel shown on the plans for the steel reinforcement. Steel areas greater than those required are not cause for rejection. The permissible variation in diameter of any wire in finished fabric is prescribed for the wire before fabrication by either AASHTO M32 or M225.

U-2714**ST-8****Wayne County****F. Marking**

1. Each section shall be match-marked in order of intended installation as indicated on the approved shop drawings. Ensure that pieces fit together neatly and in a workmanlike manner. In order to ensure a good, neat field fit, the Department will verify assembly of the first five adjacent sections or 20% of the total culvert length, whichever is greater, at the producer's facility and match-mark the pieces. This will require that a minimum of three adjacent sections of the culvert be fitted at the production yard at a time and then match-marked. Once three sections have been match-marked, the first section may be removed for shipment and a fourth section set for marking. Continue in a progressive manner until all sections have been properly match-marked. The producer shall document the GO-NO-GO dimensional measurements of each box culvert section produced through the post-pour inspection process.
2. Clearly mark each section of the box culvert in accordance with ASTM C1577, Section 15. The information requirements of Section 15.1 shall be clearly marked on the inner surface of each section.

G. Construction

1. Pre-installation Meeting – A pre-installation meeting is required prior to installation. Representatives from the Contractor, the precast box manufacturer, and the Department should attend this meeting. The precast box manufacturer representative shall be on site during installation.
2. Foundation – Foundation for precast box culvert shall meet the requirements of Section 414 of the Standard Specifications. In addition, Type VI foundation material shall be encapsulated in filter fabric conforming to Type 4 requirements in Section 1056 of the Standard Specifications. The filter fabric shall be placed perpendicular to the culvert barrel. Provide sufficient overhang beyond the excavation to allow a minimum lap of 3 feet when the foundation material is placed and fabric wrapped on top. Perpendicular sections of fabric shall be continuous. A minimum lap of 2 feet shall be provided between sections of fabric.
3. Installation – Sections shall be placed at the beginning of the outlet end of the culvert with the groove end being laid upgrade. Tongue sections shall be laid into the groove sections. Positive means shall be provided to pull each section firmly into the previously placed section so that the joints are tightly homed. Use a "come-along", box pullers or other approved methods to create a positive means of joining box sections. Construction equipment shall not have direct contact with the box section. The load of the box shall be suspended by lifting device during joining procedure.
4. Backfill – Complete backfill in accordance with Section 414 of the Standard Specifications.

U-2714**ST-9****Wayne County****4.0 BASIS OF PAYMENT**

Any additional cost of redesigning will be paid for by the Contractor if Precast Reinforced Concrete Culvert is used in lieu of the cast-in-place culvert shown on the plans. Except for Foundation Conditioning Material and Culvert Excavation, payment for the Precast Box Culvert will be a lump sum amount equal to the payment that would be allowed for construction of a Cast-in-Place Box Culvert. Plan quantities and unit bid prices will be used to compute the lump sum amount. Such price and payment will be full compensation for all work covered by this Special Provision, the plans and applicable parts of the Standard Specifications and will include, but not be limited to, furnishing all labor, materials (including all filter fabric), equipment and other incidentals necessary to complete this work. Such price and payment will also be full compensation for concrete, reinforcing steel, labor, equipment and all other related materials necessary for the completion of the barrel section, and the construction of the headwalls, leveling pad, end curtain walls, wings and wing footings.

U-2714

ST-10

Wayne County

FALSEWORK AND FORMWORK

(4-5-12)

1.0 DESCRIPTION

Use this Special Provision as a guide to develop temporary works submittals required by the Standard Specifications or other provisions; no additional submittals are required herein. Such temporary works include, but are not limited to, falsework and formwork.

Falsework is any temporary construction used to support the permanent structure until it becomes self-supporting. Formwork is the temporary structure or mold used to retain plastic or fluid concrete in its designated shape until it hardens. Access scaffolding is a temporary structure that functions as a work platform that supports construction personnel, materials, and tools, but is not intended to support the structure. Scaffolding systems that are used to temporarily support permanent structures (as opposed to functioning as work platforms) are considered to be falsework under the definitions given. Shoring is a component of falsework such as horizontal, vertical, or inclined support members. Where the term “temporary works” is used, it includes all of the temporary facilities used in bridge construction that do not become part of the permanent structure.

Design and construct safe and adequate temporary works that will support all loads imposed and provide the necessary rigidity to achieve the lines and grades shown on the plans in the final structure.

2.0 MATERIALS

Select materials suitable for temporary works; however, select materials that also ensure the safety and quality required by the design assumptions. The Engineer has authority to reject material on the basis of its condition, inappropriate use, safety, or nonconformance with the plans. Clearly identify allowable loads or stresses for all materials or manufactured devices on the plans. Revise the plan and notify the Engineer if any change to materials or material strengths is required.

3.0 DESIGN REQUIREMENTS**A. Working Drawings**

Provide working drawings for items as specified in the contract, or as required by the Engineer, with design calculations and supporting data in sufficient detail to permit a structural and safety review of the proposed design of the temporary work.

On the drawings, show all information necessary to allow the design of any component to be checked independently as determined by the Engineer.

When concrete placement is involved, include data such as the drawings of proposed sequence, rate of placement, direction of placement, and location of all construction joints. Submit the number of copies as called for by the contract.

U-2714**ST-11****Wayne County**

When required, have the drawings and calculations prepared under the guidance of, and sealed by, a North Carolina Registered Professional Engineer who is knowledgeable in temporary works design.

If requested by the Engineer, submit with the working drawings manufacturer's catalog data listing the weight of all construction equipment that will be supported on the temporary work. Show anticipated total settlements and/or deflections of falsework and forms on the working drawings. Include falsework footing settlements, joint take-up, and deflection of beams or girders.

As an option for the Contractor, overhang falsework hangers may be uniformly spaced, at a maximum of 36 inches, provided the following conditions are met:

Member Type (PCG)	Member Depth, (inches)	Max. Overhang Width, (inches)	Max. Slab Edge Thickness, (inches)	Max. Screed Wheel Weight, (lbs.)	Bracket Min. Vertical Leg Extension, (inches)
II	36	39	14	2000	26
III	45	42	14	2000	35
IV	54	45	14	2000	44
MBT	63	51	12	2000	50
MBT	72	55	12	1700	48

Overhang width is measured from the centerline of the girder to the edge of the deck slab.

For Type II, III & IV prestressed concrete girders (PCG), 45-degree cast-in-place half hangers and rods must have a minimum safe working load of 6,000 lbs.

For MBT prestressed concrete girders, 45-degree angle holes for falsework hanger rods shall be cast through the girder top flange and located, measuring along the top of the member, 1'-2 1/2" from the edge of the top flange. Hanger hardware and rods must have a minimum safe working load of 6,000 lbs.

The overhang bracket provided for the diagonal leg shall have a minimum safe working load of 3,750 lbs. The vertical leg of the bracket shall extend to the point that the heel bears on the girder bottom flange, no closer than 4 inches from the bottom of the member. However, for 72-inch members, the heel of the bracket shall bear on the web, near the bottom flange transition.

Provide adequate overhang falsework and determine the appropriate adjustments for deck geometry, equipment, casting procedures and casting conditions.

If the optional overhang falsework spacing is used, indicate this on the falsework submittal and advise the girder producer of the proposed details. Failure to notify the Engineer of hanger type and hanger spacing on prestressed concrete girder casting drawings may delay the approval of those drawings.

U-2714**ST-12****Wayne County**

Falsework hangers that support concentrated loads and are installed at the edge of thin top flange concrete girders (such as bulb tee girders) shall be spaced so as not to exceed 75% of the manufacturer's stated safe working load. Use of dual leg hangers (such as Meadow Burke HF-42 and HF-43) are not allowed on concrete girders with thin top flanges. Design the falsework and forms supporting deck slabs and overhangs on girder bridges so that there will be no differential settlement between the girders and the deck forms during placement of deck concrete.

When staged construction of the bridge deck is required, detail falsework and forms for screed and fluid concrete loads to be independent of any previous deck pour components when the mid-span girder deflection due to deck weight is greater than $\frac{3}{4}$ ".

Note on the working drawings any anchorages, connectors, inserts, steel sleeves or other such devices used as part of the falsework or formwork that remains in the permanent structure. If the plan notes indicate that the structure contains the necessary corrosion protection required for a Corrosive Site, epoxy coat, galvanize or metalize these devices. Electroplating will not be allowed. Any coating required by the Engineer will be considered incidental to the various pay items requiring temporary works.

U-2714

ST-13

Wayne County

Design falsework and formwork requiring submittals in accordance with the 1995 AASHTO *Guide Design Specifications for Bridge Temporary Works* except as noted herein.

1. Wind Loads

Table 2.2 of Article 2.2.5.1 is modified to include wind velocities up to 110 mph. In addition, Table 2.2A is included to provide the maximum wind speeds by county in North Carolina.

Table 2.2 - Wind Pressure Values

Height Zone feet above ground	Pressure, lb/ft ² for Indicated Wind Velocity, mph				
	70	80	90	100	110
0 to 30	15	20	25	30	35
30 to 50	20	25	30	35	40
50 to 100	25	30	35	40	45
over 100	30	35	40	45	50

2. Time of Removal

The following requirements replace those of Article 3.4.8.2.

Do not remove forms until the concrete has attained strengths required in Article 420-16 of the Standard Specifications and these Special Provisions.

Do not remove forms until the concrete has sufficient strength to prevent damage to the surface.

U-2714

ST-14

Wayne County

Table 2.2A - Steady State Maximum Wind Speeds by Counties in North Carolina

COUNTY	25 YR (mph)	COUNTY	25 YR (mph)	COUNTY	25 YR (mph)
Alamance	70	Franklin	70	Pamlico	100
Alexander	70	Gaston	70	Pasquotank	100
Alleghany	70	Gates	90	Pender	100
Anson	70	Graham	80	Perquimans	100
Ashe	70	Granville	70	Person	70
Avery	70	Greene	80	Pitt	90
Beaufort	100	Guilford	70	Polk	80
Bertie	90	Halifax	80	Randolph	70
Bladen	90	Harnett	70	Richmond	70
Brunswick	100	Haywood	80	Robeson	80
Buncombe	80	Henderson	80	Rockingham	70
Burke	70	Hertford	90	Rowan	70
Cabarrus	70	Hoke	70	Rutherford	70
Caldwell	70	Hyde	110	Sampson	90
Camden	100	Iredell	70	Scotland	70
Carteret	110	Jackson	80	Stanley	70
Caswell	70	Johnston	80	Stokes	70
Catawba	70	Jones	100	Surry	70
Cherokee	80	Lee	70	Swain	80
Chatham	70	Lenoir	90	Transylvania	80
Chowan	90	Lincoln	70	Tyrell	100
Clay	80	Macon	80	Union	70
Cleveland	70	Madison	80	Vance	70
Columbus	90	Martin	90	Wake	70
Craven	100	McDowell	70	Warren	70
Cumberland	80	Mecklenburg	70	Washington	100
Currituck	100	Mitchell	70	Watauga	70
Dare	110	Montgomery	70	Wayne	80
Davidson	70	Moore	70	Wilkes	70
Davie	70	Nash	80	Wilson	80
Duplin	90	New Hanover	100	Yadkin	70
Durham	70	Northampton	80	Yancey	70
Edgecombe	80	Onslow	100		
Forsyth	70	Orange	70		

U-2714**ST-15****Wayne County****B. Review and Approval**

The Engineer is responsible for the review and approval of temporary works' drawings.

Submit the working drawings sufficiently in advance of proposed use to allow for their review, revision (if needed), and approval without delay to the work.

The time period for review of the working drawings does not begin until complete drawings and design calculations, when required, are received by the Engineer.

Do not start construction of any temporary work for which working drawings are required until the drawings have been approved. Such approval does not relieve the Contractor of the responsibility for the accuracy and adequacy of the working drawings.

4.0 CONSTRUCTION REQUIREMENTS

All requirements of Section 420 of the Standard Specifications apply.

Construct temporary works in conformance with the approved working drawings. Ensure that the quality of materials and workmanship employed is consistent with that assumed in the design of the temporary works. Do not weld falsework members to any portion of the permanent structure unless approved. Show any welding to the permanent structure on the approved construction drawings.

Provide tell-tales attached to the forms and extending to the ground, or other means, for accurate measurement of falsework settlement. Make sure that the anticipated compressive settlement and/or deflection of falsework does not exceed 1 inch. For cast-in-place concrete structures, make sure that the calculated deflection of falsework flexural members does not exceed 1/240 of their span regardless of whether or not the deflection is compensated by camber strips.

A. Maintenance and Inspection

Inspect and maintain the temporary work in an acceptable condition throughout the period of its use. Certify that the manufactured devices have been maintained in a condition to allow them to safely carry their rated loads. Clearly mark each piece so that its capacity can be readily determined at the job site.

Perform an in-depth inspection of an applicable portion(s) of the temporary works, in the presence of the Engineer, not more than 24 hours prior to the beginning of each concrete placement. Inspect other temporary works at least once a month to ensure that they are functioning properly. Have a North Carolina Registered Professional Engineer inspect the cofferdams, shoring, sheathing, support of excavation structures, and support systems for load tests prior to loading.

U-2714**ST-16****Wayne County****B. Foundations**

Determine the safe bearing capacity of the foundation material on which the supports for temporary works rest. If required by the Engineer, conduct load tests to verify proposed bearing capacity values that are marginal or in other high-risk situations.

The use of the foundation support values shown on the contract plans of the permanent structure is permitted if the foundations are on the same level and on the same soil as those of the permanent structure.

Allow for adequate site drainage or soil protection to prevent soil saturation and washout of the soil supporting the temporary works supports.

If piles are used, the estimation of capacities and later confirmation during construction using standard procedures based on the driving characteristics of the pile is permitted. If preferred, use load tests to confirm the estimated capacities; or, if required by the Engineer conduct load tests to verify bearing capacity values that are marginal or in other high risk situations.

The Engineer reviews and approves the proposed pile and soil bearing capacities.

5.0 REMOVAL

Unless otherwise permitted, remove and keep all temporary works upon completion of the work. Do not disturb or otherwise damage the finished work.

Remove temporary works in conformance with the contract documents. Remove them in such a manner as to permit the structure to uniformly and gradually take the stresses due to its own weight.

6.0 METHOD OF MEASUREMENT

Unless otherwise specified, temporary works will not be directly measured.

7.0 BASIS OF PAYMENT

Payment at the contract unit prices for the various pay items requiring temporary works will be full compensation for the above falsework and formwork.

U-2714

ST-17

Wayne County

SUBMITTAL OF WORKING DRAWINGS

(6-28-17)

1.0 GENERAL

Submit working drawings in accordance with Article 105-2 of the *Standard Specifications* and this provision. For this provision, “submittals” refers to only those listed in this provision. The list of submittals contained herein does not represent a list of required submittals for the project. Submittals are only necessary for those items as required by the contract. Make submittals that are not specifically noted in this provision directly to the Engineer. Either the Structures Management Unit or the Geotechnical Engineering Unit or both units will jointly review submittals.

If a submittal contains variations from plan details or specifications or significantly affects project cost, field construction or operations, discuss the submittal with and submit all copies to the Engineer. State the reason for the proposed variation in the submittal. To minimize review time, make sure all submittals are complete when initially submitted. Provide a contact name and information with each submittal. Direct any questions regarding submittal requirements to the Engineer, Structures Management Unit contacts or the Geotechnical Engineering Unit contacts noted below.

In order to facilitate in-plant inspection by NCDOT and approval of working drawings, provide the name, address and telephone number of the facility where fabrication will actually be done if different than shown on the title block of the submitted working drawings. This includes, but is not limited to, precast concrete items, prestressed concrete items and fabricated steel or aluminum items.

2.0 ADDRESSES AND CONTACTS

For submittals to the Structures Management Unit, use the following addresses:

Via US mail:

Mr. B. C. Hanks, P. E.
State Structures Engineer
North Carolina Department
of Transportation
Structures Management Unit
1581 Mail Service Center
Raleigh, NC 27699-1581

Attention: Mr. J. L. Bolden, P. E.

Via other delivery service:

Mr. B. C. Hanks, P. E.
State Structures Engineer
North Carolina Department
of Transportation
Structures Management Unit
1000 Birch Ridge Drive
Raleigh, NC 27610

Attention: Mr. J. L. Bolden, P. E.

Submittals may also be made via email.

Send submittals to:

jlbolden@ncdot.gov (James Bolden)

Send an additional e-copy of the submittal to the following address:

eomile@ncdot.gov (Emmanuel Omile)

U-2714

ST-18

Wayne County

mrorie@ncdot.gov (Madonna Rorie)

For submittals to the Geotechnical Engineering Unit, use the following addresses:

For projects in Divisions 1-7, use the following Eastern Regional Office address:

Via US mail:

Mr. Chris Kreider, P. E.
Eastern Regional Geotechnical
Manager
North Carolina Department
of Transportation
Geotechnical Engineering Unit
Eastern Regional Office
1570 Mail Service Center
Raleigh, NC 27699-1570

Via other delivery service:

Mr. Chris Kreider, P. E.
Eastern Regional Geotechnical
Manager
North Carolina Department
of Transportation
Geotechnical Engineering Unit
Eastern Regional Office
3301 Jones Sausage Road, Suite 100
Garner, NC 27529

Via Email: EastGeotechnicalSubmittal@ncdot.gov

For projects in Divisions 8-14, use the following Western Regional Office address:

Via US mail or other delivery service:

Mr. Eric Williams, P. E.
Western Regional Geotechnical
Manager
North Carolina Department
of Transportation
Geotechnical Engineering Unit
Western Regional Office
5253 Z Max Boulevard
Harrisburg, NC 28075

Via Email: WestGeotechnicalSubmittal@ncdot.gov

The status of the review of structure-related submittals sent to the Structures Management Unit can be viewed from the Unit's website, via the "Drawing Submittal Status" link.

The status of the review of geotechnical-related submittals sent to the Geotechnical Engineering Unit can be viewed from the Unit's website, via the "Geotechnical Construction Submittals" link.

Direct any questions concerning submittal review status, review comments or drawing markups to the following contacts:

Primary Structures Contact:

James Bolden (919) 707 – 6408
(919) 250 – 4082 facsimile
jlbolden@ncdot.gov

U-2714

ST-19

Wayne County

Secondary Structures Contacts: Emmanuel Omile (919) 707 – 6451
Madonna Rorie (919) 707 – 6508

Eastern Regional Geotechnical Contact (Divisions 1-7):
Chris Kreider (919) 662 – 4710
ckreider@ncdot.gov

Western Regional Geotechnical Contact (Divisions 8-14):
Eric Williams (704) 455 – 8902
ewilliams3@ncdot.gov

3.0 SUBMITTAL COPIES

Furnish one complete copy of each submittal, including all attachments, to the Engineer. At the same time, submit the number of hard copies shown below of the same complete submittal directly to the Structures Management Unit and/or the Geotechnical Engineering Unit.

The first table below covers “Structure Submittals”. The Engineer will receive review comments and drawing markups for these submittals from the Structures Management Unit. The second table in this section covers “Geotechnical Submittals”. The Engineer will receive review comments and drawing markups for these submittals from the Geotechnical Engineering Unit.

Unless otherwise required, submit one set of supporting calculations to either the Structures Management Unit or the Geotechnical Engineering Unit unless both units require submittal copies in which case submit a set of supporting calculations to each unit. Provide additional copies of any submittal as directed.

STRUCTURE SUBMITTALS

Submittal	Copies Required by Structures Management Unit	Copies Required by Geotechnical Engineering Unit	Contract Reference Requiring Submittal ¹
Arch Culvert Falsework	5	0	Plan Note, SN Sheet & “Falsework and Formwork”
Box Culvert Falsework ⁷	5	0	Plan Note, SN Sheet & “Falsework and Formwork”
Cofferdams	6	2	Article 410-4
Foam Joint Seals ⁶	9	0	“Foam Joint Seals”

U-2714**ST-20****Wayne County**

Expansion Joint Seals (hold down plate type with base angle)	9	0	“Expansion Joint Seals”
Expansion Joint Seals (modular)	2, then 9	0	“Modular Expansion Joint Seals”
Expansion Joint Seals (strip seals)	9	0	“Strip Seals”
Falsework & Forms ² (substructure)	8	0	Article 420-3 & “Falsework and Formwork”
Falsework & Forms (superstructure)	8	0	Article 420-3 & “Falsework and Formwork”
Girder Erection over Railroad	5	0	Railroad Provisions
Maintenance and Protection of Traffic Beneath Proposed Structure	8	0	“Maintenance and Protection of Traffic Beneath Proposed Structure at Station ____”
Metal Bridge Railing	8	0	Plan Note
Metal Stay-in-Place Forms	8	0	Article 420-3
Metalwork for Elastomeric Bearings ^{4,5}	7	0	Article 1072-8
Miscellaneous Metalwork ^{4,5}	7	0	Article 1072-8
Disc Bearings ⁴	8	0	“Disc Bearings”
Overhead and Digital Message Signs (DMS) (metalwork and foundations)	13	0	Applicable Provisions
Placement of Equipment on Structures (cranes, etc.)	7	0	Article 420-20
Precast Concrete Box Culverts	2, then 1 reproducible	0	“Optional Precast Reinforced Concrete Box Culvert at Station 75+49.09”
Prestressed Concrete Cored Slab (detensioning sequences) ³	6	0	Article 1078-11
Prestressed Concrete Deck Panels	6 and 1 reproducible	0	Article 420-3

U-2714**ST-21****Wayne County**

Prestressed Concrete Girder (strand elongation and detensioning sequences)	6	0	Articles 1078-8 and 1078- 11
Removal of Existing Structure over Railroad	5	0	Railroad Provisions
Revised Bridge Deck Plans (adaptation to prestressed deck panels)	2, then 1 reproducible	0	Article 420-3
Revised Bridge Deck Plans (adaptation to modular expansion joint seals)	2, then 1 reproducible	0	“Modular Expansion Joint Seals”
Sound Barrier Wall (precast items)	10	0	Article 1077-2 & “Sound Barrier Wall”
Sound Barrier Wall Steel Fabrication Plans ⁵	7	0	Article 1072-8 & “Sound Barrier Wall”
Structural Steel ⁴	2, then 7	0	Article 1072-8 Article 400-3 & “Construction, Maintenance and Removal of Temporary Structure at Station _____”
Temporary Detour Structures	10	2	
TFE Expansion Bearings ⁴	8	0	Article 1072-8

FOOTNOTES

1. References are provided to help locate the part of the contract where the submittals are required. References in quotes refer to the provision by that name. Articles refer to the *Standard Specifications*.
2. Submittals for these items are necessary only when required by a note on plans.
3. Submittals for these items may not be required. A list of pre-approved sequences is available from the producer or the Materials & Tests Unit.
4. The fabricator may submit these items directly to the Structures Management Unit.
5. The two sets of preliminary submittals required by Article 1072-8 of the *Standard Specifications* are not required for these items.
6. Submittals for Fabrication Drawings are not required. Submittals for Catalogue Cuts of Proposed Material are required. See Section 5.A of the referenced provision.
7. Submittals are necessary only when the top slab thickness is 18” or greater.

U-2714

ST-22

Wayne County

GEOTECHNICAL SUBMITTALS

Submittal	Copies Required by Geotechnical Engineering Unit	Copies Required by Structures Management Unit	Contract Reference Requiring Submittal ¹
Drilled Pier Construction Plans ²	1	0	Subarticle 411-3(A)
Crosshole Sonic Logging (CSL) Reports ²	1	0	Subarticle 411-5(A)(2)
Pile Driving Equipment Data Forms ^{2,3}	1	0	Subarticle 450-3(D)(2)
Pile Driving Analyzer (PDA) Reports ²	1	0	Subarticle 450-3(F)(3)
Retaining Walls ⁴	1 drawings, 1 calculations	2 drawings	Applicable Provisions
Temporary Shoring ⁴	1 drawings, 1 calculations	2 drawings	“Temporary Shoring” & “Temporary Soil Nail Walls”

FOOTNOTES

- References are provided to help locate the part of the contract where the submittals are required. References in quotes refer to the provision by that name. Subarticles refer to the *Standard Specifications*.
- Submit one hard copy of submittal to the Engineer. Submit a second copy of submittal electronically (PDF via email), US mail or other delivery service to the appropriate Geotechnical Engineering Unit regional office. Electronic submission is preferred.
- The Pile Driving Equipment Data Form is available from:
https://connect.ncdot.gov/resources/Geological/Pages/Geotech_Forms_Details.aspx
See second page of form for submittal instructions.
- Electronic copy of submittal is required. See referenced provision.

U-2714

ST-23

Wayne County

CRANE SAFETY**(6-20-19)**

Comply with the manufacturer specifications and limitations applicable to the operation of any and all cranes and derricks. Prime contractors, sub-contractors, and fully operated rental companies shall comply with the current Occupational Safety and Health Administration (OSHA) regulations.

Submit all items listed below to the Engineer prior to beginning crane operations. Changes in personnel or equipment must be reported to the Engineer and all applicable items listed below must be updated and submitted prior to continuing with crane operations.

CRANE SAFETY SUBMITTAL LIST

- A. **Competent Person:** Provide the name and qualifications of the “Competent Person” responsible for crane safety and lifting operations. The named competent person will have the responsibility and authority to stop any work activity due to safety concerns.
- B. **Riggers:** Provide the qualifications and experience of the persons responsible for rigging operations. Qualifications and experience should include, but not be limited to, weight calculations, center of gravity determinations, selection and inspection of sling and rigging equipment, and safe rigging practices.
- C. **Crane Inspections:** Inspection records for all cranes shall be current and readily accessible for review upon request.
- D. **Certifications:** Crane operators shall be certified by the National Commission for the Certification of Crane Operators (NCCCO) or the National Center for Construction Education and Research (NCCER). Other approved nationally accredited programs will be considered upon request. In addition, crane operators shall have a current CDL medical card. Submit a list of crane operator(s) and include current certification for each type of crane operated (small hydraulic, large hydraulic, small lattice, large lattice) and medical evaluations for each operator.

U-2714

ST-24

Wayne County

GROUT FOR STRUCTURES

(12-1-17)

1.0 DESCRIPTION

This special provision addresses grout for use in pile blockouts, grout pockets, shear keys, dowel holes and recesses for structures. This provision does not apply to grout placed in post-tensioning ducts for bridge beams, girders, decks, end bent caps, or bent caps. Mix and place grout in accordance with the manufacturer's recommendations, the applicable sections of the Standard Specifications and this provision.

2.0 MATERIAL REQUIREMENTS

Unless otherwise noted on the plans, use a Type 3 Grout in accordance with Section 1003 of the Standard Specifications.

Initial setting time shall not be less than 10 minutes when tested in accordance with ASTM C266.

Construction loading and traffic loading shall not be allowed until the 3 day compressive strength is achieved.

3.0 SAMPLING AND PLACEMENT

Place and maintain components in final position until grout placement is complete and accepted. Concrete surfaces to receive grout shall be free of defective concrete, laitance, oil, grease and other foreign matter. Saturate concrete surfaces with clean water and remove excess water prior to placing grout.

4.0 BASIS OF PAYMENT

No separate payment will be made for "Grout for Structures". The cost of the material, equipment, labor, placement, and any incidentals necessary to complete the work shall be considered incidental to the structure item requiring grout.

PROJECT SPECIAL PROVISION

(10-18-95) (Rev. 3-21-17)

Z-1a

PERMITS

The Contractor's attention is directed to the following permits, which have been issued to the Department of Transportation by the authority granting the permit.

<u>PERMIT</u>	<u>AUTHORITY GRANTING THE PERMIT</u>
Dredge and Fill and/or Work in Navigable Waters (404)	U. S. Army Corps of Engineers
Water Quality (401)	Division of Environmental Management, DEQ State of North Carolina
Buffer Certification	Division of Environmental Management, DEQ State of North Carolina

The Contractor shall comply with all applicable permit conditions during construction of this project. Those conditions marked by * are the responsibility of the Department and the Contractor has no responsibility in accomplishing those conditions.

Agents of the permitting authority will periodically inspect the project for adherence to the permits.

The Contractor's attention is also directed to Articles 107-10 and 107-13 of the *2018 Standard Specifications* and the following:

Should the Contractor propose to utilize construction methods (such as temporary structures or fill in waters and/or wetlands for haul roads, work platforms, cofferdams, etc.) not specifically identified in the permit (individual, general, or nationwide) authorizing the project it shall be the Contractor's responsibility to coordinate with the Engineer to determine what, if any, additional permit action is required. The Contractor shall also be responsible for initiating the request for the authorization of such construction method by the permitting agency. The request shall be submitted through the Engineer. The Contractor shall not utilize the construction method until it is approved by the permitting agency. The request normally takes approximately 60 days to process; however, no extensions of time or additional compensation will be granted for delays resulting from the Contractor's request for approval of construction methods not specifically identified in the permit.

Where construction moratoriums are contained in a permit condition which restricts the Contractor's activities to certain times of the year, those moratoriums will apply only to the portions of the work taking place in the restricted waters, wetlands or buffer zones, provided that activities outside those areas is done in such a manner as to not affect the restricted waters, wetlands or buffer zones.

U.S. ARMY CORPS OF ENGINEERS
WILMINGTON DISTRICT

Action Id. SAW-2018-02162

County: Wayne County U.S.G.S. Quad: Northeast Goldsboro

GENERAL PERMIT (REGIONAL AND NATIONWIDE) VERIFICATION

Permittee: Chad Coggins
NCDOT/ Division 4 Environmental Officer
Address: PO Box 3165
Wilson NC, 27895
Telephone Number: C 252.717.8699

Size (acres) N/A Nearest Town Goldsboro
Nearest Waterway Little River River Basin Neuse
USGS HUC 03020202 Coordinates Latitude: 35.41195; Longitude: -77.98273
Location description: US 117A, between US 70 and SR 1571 (Tommys Road), in Goldsboro, NC

Description of projects area and activity: TIP U-2714; Road widening impacting 98 linear feet of tributary

Applicable Law: Section 404 (Clean Water Act, 33 USC 1344); Section 10 (Rivers and Harbors Act, 33 USC 403)

Authorization: Nationwide Permit Number: NWP 14 Linear Transportation Projects
SEE ATTACHED NWP GENERAL, REGIONAL AND/OR SPECIAL CONDITIONS

Your work is authorized by the above referenced permit provided it is accomplished in strict accordance with the attached conditions and your submitted application and attached information dated November 16, 2018. Any violation of the attached conditions or deviation from your submitted plans may subject the permittee to a stop work order, a restoration order, a Class I administrative penalty, and/or appropriate legal action.

SPECIAL CONDITION

1. This USACE permit does not authorize you to take a threatened or endangered species, in particular, the Northern Long-eared Bat (NLEB) (*Myotis septentrionalis*). In order to legally take a listed species, you must have separate authorization under the Endangered Species Act (ESA) (e.g., a Biological Opinion (BO) under the ESA, Section 7, with ‘incidental take’ provisions with which you must comply). The U.S. Fish and Wildlife Service’s (USFWS’s) Programmatic BO titled ‘Northern Long-eared Bat (NLEB) Programmatic Biological Opinion for North Carolina Department of Transportation (NCDOT) Activities in Eastern North Carolina (Divisions 1-8),’ dated March 25, 2015, and adopted on May 4, 2015, contains mandatory terms and conditions to implement the reasonable and prudent measures that are associated with ‘incidental take’ that are specified in the BO. Your authorization under this USACE permit is conditioned upon your compliance with all the mandatory terms and conditions (incorporated by reference into this permit) associated with incidental take of the BO. Failure to comply with the terms and conditions associated with incidental take of the BO, where a take of the listed species occurs, would constitute an unauthorized take, and would also constitute non-compliance with your USACE permit. The USFWS is the appropriate authority to determine compliance with the terms and conditions of its BO and with the ESA.

This verification will remain valid until the expiration date identified below unless the nationwide and/or regional general permit authorization is modified, suspended or revoked. If, prior to the expiration date identified below, the nationwide and/or regional general permit authorization is reissued and/or modified, this verification will remain valid until the expiration date identified below, provided it complies with all requirements of the modified nationwide permit. If the nationwide and/or regional general permit authorization expires or is suspended, revoked, or is modified, such that the activity would no longer comply with the terms and conditions of the nationwide permit, activities which have commenced (i.e., are under construction) or are under contract to commence in reliance upon the nationwide and/or regional general permit, will remain authorized provided the activity is completed within twelve months of the date of the nationwide and/or regional general permit’s expiration, modification or revocation, unless discretionary authority has been exercised on a case-by-case basis to modify, suspend or revoke the authorization.

This Department of the Army verification does not relieve the permittee of the responsibility to obtain any other required Federal, State or local approvals/permits.

If there are any questions regarding this verification, any of the conditions of the Permit, or the Corps of Engineers regulatory program, please contact Eric Alsmeyer at (919) 554-4884 X 23 or Eric.C.Alsmever@usace.army.mil.



Digitally signed by
MATTHEWS.MONTE.K.1284867633
DN: c=US, o=U.S. Government, ou=DoD,
ou=PKI, ou=USA,
cn=MATTHEWS.MONTE.K.1284867633
Date: 2018.11.20 07:14:34 -05'00'

Corps Regulatory Official: _____
Date: **November 20, 2018;** Expiration Date of Verification: **March 18, 2022**

The Wilmington District is committed to providing the highest level of support to the public. To help us ensure we continue to do so, please complete our Customer Satisfaction Survey, located online at http://corpsmapu.usace.army.mil/cm_apex/f?p=136:4:0.

Action ID Number: SAW-2018-02162 County: Wayne County

Permittee: Chad Coggins
NCDOT/ Division 4 Environmental Officer

Project Name: NCDOT U-2714 US117A widen Wayne Div4

Date Verification Issued: November 20, 2018

Project Manager: Eric Alsmeyer

Upon completion of the activity authorized by this permit and any mitigation required by the permit, sign this certification and return it to the following address:

US ARMY CORPS OF ENGINEERS
WILMINGTON DISTRICT
Attn: Eric Alsmeyer
Raleigh Regulatory Field Office
3331 Heritage Trade Drive, Suite 105
Wake Forest, NC 27587

Please note that your permitted activity is subject to a compliance inspection by a U. S. Army Corps of Engineers representative. Failure to comply with any terms or conditions of this authorization may result in the Corps suspending, modifying or revoking the authorization and/or issuing a Class I administrative penalty, or initiating other appropriate legal action.

I hereby certify that the work authorized by the above referenced permit has been completed in accordance with the terms and condition of the said permit, and required mitigation was completed in accordance with the permit conditions.

**NATIONWIDE PERMIT 14
DEPARTMENT OF THE ARMY
CORPS OF ENGINEERS
FINAL NOTICE OF ISSUANCE AND MODIFICATION OF NATIONWIDE PERMITS
FEDERAL REGISTER
AUTHORIZED MARCH 19, 2017**

Linear Transportation Projects. Activities required for crossings of waters of the United States associated with the construction, expansion, modification, or improvement of linear transportation projects (e.g., roads, highways, railways, trails, airport runways, and taxiways) in waters of the United States. For linear transportation projects in non-tidal waters, the discharge cannot cause the loss of greater than 1/2-acre of waters of the United States. For linear transportation projects in tidal waters, the discharge cannot cause the loss of greater than 1/3-acre of waters of the United States. Any stream channel modification, including bank stabilization, is limited to the minimum necessary to construct or protect the linear transportation project; such modifications must be in the immediate vicinity of the project.

This NWP also authorizes temporary structures, fills, and work, including the use of temporary mats, necessary to construct the linear transportation project. Appropriate measures must be taken to maintain normal downstream flows and minimize flooding to the maximum extent practicable, when temporary structures, work, and discharges, including cofferdams, are necessary for construction activities, access fills, or dewatering of construction sites. Temporary fills must consist of materials, and be placed in a manner, that will not be eroded by expected high flows. Temporary fills must be removed in their entirety and the affected areas returned to pre-construction elevations. The areas affected by temporary fills must be revegetated, as appropriate.

This NWP cannot be used to authorize non-linear features commonly associated with transportation projects, such as vehicle maintenance or storage buildings, parking lots, train stations, or aircraft hangars.

* **Notification:** The permittee must submit a pre-construction notification to the district engineer prior to commencing the activity if: (1) the loss of waters of the United States exceeds 1/10-acre; or (2) there is a discharge in a special aquatic site, including wetlands. (See general condition 32.) (Authorities: Sections 10 and 404)

Note 1: For linear transportation projects crossing a single waterbody more than one time at separate and distant locations, or multiple waterbodies at separate and distant locations, each crossing is considered a single and complete project for purposes of NWP authorization. Linear transportation projects must comply with 33 CFR 330.6(d).

Note 2: Some discharges for the construction of farm roads or forest roads, or temporary roads for moving mining equipment, may qualify for an exemption under section 404(f) of the Clean Water Act (see 33 CFR 323.4).

Note 3: For NWP 14 activities that require pre-construction notification, the PCN must include any other NWP(s), regional general permit(s), or individual permit(s) used or intended

P-6

to be used to authorize any part of the proposed project or any related activity, including other separate and distant crossings that require Department of the Army authorization but do not require pre-construction notification (see paragraph (b) of general condition 32). The district engineer will evaluate the PCN in accordance with Section D, "District Engineer's Decision." The district engineer may require mitigation to ensure that the authorized activity results in no more than minimal individual and cumulative adverse environmental effects (see general condition 23).

NATIONWIDE PERMIT GENERAL CONDITIONS

The following General Conditions must be followed in order for any authorization by a NWP to be valid:

1. Navigation. (a) No activity may cause more than a minimal adverse effect on navigation.

(b) Any safety lights and signals prescribed by the U.S. Coast Guard, through regulations or otherwise, must be installed and maintained at the permittee's expense on authorized facilities in navigable waters of the United States.

(c) The permittee understands and agrees that, if future operations by the United States require the removal, relocation, or other alteration, of the structure or work herein authorized, or if, in the opinion of the Secretary of the Army or his authorized representative, said structure or work shall cause unreasonable obstruction to the free navigation of the navigable waters, the permittee will be required, upon due notice from the Corps of Engineers, to remove, relocate, or alter the structural work or obstructions caused thereby, without expense to the United States. No claim shall be made against the United States on account of any such removal or alteration.

2. Aquatic Life Movements. No activity may substantially disrupt the necessary life cycle movements of those species of aquatic life indigenous to the waterbody, including those species that normally migrate through the area, unless the activity's primary purpose is to impound water. All permanent and temporary crossings of waterbodies shall be suitably culverted, bridged, or otherwise designed and constructed to maintain low flows to sustain the movement of those aquatic species. If a bottomless culvert cannot be used, then the crossing should be designed and constructed to minimize adverse effects to aquatic life movements.

3. Spawning Areas. Activities in spawning areas during spawning seasons must be avoided to the maximum extent practicable. Activities that result in the physical destruction (e.g., through excavation, fill, or downstream smothering by substantial turbidity) of an important spawning area are not authorized.

4. Migratory Bird Breeding Areas. Activities in waters of the United States that serve as breeding areas for migratory birds must be avoided to the maximum extent practicable.

5. Shellfish Beds. No activity may occur in areas of concentrated shellfish populations, unless the activity is directly related to a shellfish harvesting activity authorized by NWPs 4 and 48, or is a shellfish seeding or habitat restoration activity authorized by NWP 27.

6. Suitable Material. No activity may use unsuitable material (e.g., trash, debris, car bodies, asphalt, etc.). Material used for construction or discharged must be free from toxic pollutants in toxic amounts (see section 307 of the Clean Water Act).

7. Water Supply Intakes. No activity may occur in the proximity of a public water supply intake, except where the activity is for the repair or improvement of public water supply intake structures or adjacent bank stabilization.

8. Adverse Effects From Impoundments. If the activity creates an impoundment of water, adverse effects to the aquatic system due to accelerating the passage of water, and/or restricting its flow must be minimized to the maximum extent practicable.

9. Management of Water Flows. To the maximum extent practicable, the pre-construction course, condition, capacity, and location of open waters must be maintained for each activity, including stream channelization, storm water management activities, and temporary and permanent road crossings, except as provided below. The activity must be constructed to withstand expected high flows. The activity must not restrict or impede the passage of normal or high flows, unless the primary purpose of the activity is to impound water or manage high flows. The activity may alter the pre-construction course, condition, capacity, and location of open waters if it benefits the aquatic environment (e.g., stream restoration or relocation activities).

10. Fills Within 100-Year Floodplains. The activity must comply with applicable FEMA-approved state or local floodplain management requirements.

11. Equipment. Heavy equipment working in wetlands or mudflats must be placed on mats, or other measures must be taken to minimize soil disturbance.

12. Soil Erosion and Sediment Controls. Appropriate soil erosion and sediment controls must be used and maintained in effective operating condition during construction, and all exposed soil and other fills, as well as any work below the ordinary high water mark or high tide line, must be permanently stabilized at the earliest practicable date. Permittees are encouraged to perform work within waters of the United States during periods of low-flow or no-flow, or during low tides.

13. Removal of Temporary Fills. Temporary fills must be removed in their entirety and the affected areas returned to pre-construction elevations. The affected areas must be revegetated, as appropriate.

14. Proper Maintenance. Any authorized structure or fill shall be properly maintained, including maintenance to ensure public safety and compliance with applicable NWP general conditions, as well as any activity-specific conditions added by the district engineer to an NWP authorization.

15. Single and Complete Project. The activity must be a single and complete project. The same NWP cannot be used more than once for the same single and complete project.

16. Wild and Scenic Rivers. (a) No NWP activity may occur in a component of the National Wild and Scenic River System, or in a river officially designated by Congress as a “study river” for possible inclusion in the system while the river is in an official study status,

unless the appropriate Federal agency with direct management responsibility for such river, has determined in writing that the proposed activity will not adversely affect the Wild and Scenic River designation or study status.

(b) If a proposed NWP activity will occur in a component of the National Wild and Scenic River System, or in a river officially designated by Congress as a “study river” for possible inclusion in the system while the river is in an official study status, the permittee must submit a pre-construction notification (see general condition 32). The district engineer will coordinate the PCN with the Federal agency with direct management responsibility for that river. The permittee shall not begin the NWP activity until notified by the district engineer that the Federal agency with direct management responsibility for that river has determined in writing that the proposed NWP activity will not adversely affect the Wild and Scenic River designation or study status.

(c) Information on Wild and Scenic Rivers may be obtained from the appropriate Federal land management agency responsible for the designated Wild and Scenic River or study river (e.g., National Park Service, U.S. Forest Service, Bureau of Land Management, U.S. Fish and Wildlife Service). Information on these rivers is also available at: <http://www.rivers.gov/>.

17. Tribal Rights. No NWP activity may cause more than minimal adverse effects on tribal rights (including treaty rights), protected tribal resources, or tribal lands.

18. Endangered Species. (a) No activity is authorized under any NWP which is likely to directly or indirectly jeopardize the continued existence of a threatened or endangered species or a species proposed for such designation, as identified under the Federal Endangered Species Act (ESA), or which will directly or indirectly destroy or adversely modify the critical habitat of such species. No activity is authorized under any NWP which “may affect” a listed species or critical habitat, unless ESA section 7 consultation addressing the effects of the proposed activity has been completed. Direct effects are the immediate effects on listed species and critical habitat caused by the NWP activity. Indirect effects are those effects on listed species and critical habitat that are caused by the NWP activity and are later in time, but still are reasonably certain to occur.

(b) Federal agencies should follow their own procedures for complying with the requirements of the ESA. If pre-construction notification is required for the proposed activity, the Federal permittee must provide the district engineer with the appropriate documentation to demonstrate compliance with those requirements. The district engineer will verify that the appropriate documentation has been submitted. If the appropriate documentation has not been submitted, additional ESA section 7 consultation may be necessary for the activity and the respective federal agency would be responsible for fulfilling its obligation under section 7 of the ESA.

* (c) Non-federal permittees must submit a pre-construction notification to the district engineer if any listed species or designated critical habitat might be affected or is in the vicinity of the activity, or if the activity is located in designated critical habitat, and shall not begin work on the activity until notified by the district engineer that the requirements of the ESA have been satisfied and that the activity is authorized. For activities that might affect Federally-listed endangered or threatened species or designated critical habitat, the pre-construction notification must include the name(s) of the endangered or threatened species that

might be affected by the proposed activity or that utilize the designated critical habitat that might be affected by the proposed activity. The district engineer will determine whether the proposed activity “may affect” or will have “no effect” to listed species and designated critical habitat and will notify the non-Federal applicant of the Corps’ determination within 45 days of receipt of a complete pre-construction notification. In cases where the non-Federal applicant has identified listed species or critical habitat that might be affected or is in the vicinity of the activity, and has so notified the Corps, the applicant shall not begin work until the Corps has provided notification that the proposed activity will have “no effect” on listed species or critical habitat, or until ESA section 7 consultation has been completed. If the non-Federal applicant has not heard back from the Corps within 45 days, the applicant must still wait for notification from the Corps.

(d) As a result of formal or informal consultation with the FWS or NMFS the district engineer may add species-specific permit conditions to the NWP.

(e) Authorization of an activity by an NWP does not authorize the “take” of a threatened or endangered species as defined under the ESA. In the absence of separate authorization (e.g., an ESA Section 10 Permit, a Biological Opinion with “incidental take” provisions, etc.) from the FWS or the NMFS, the Endangered Species Act prohibits any person subject to the jurisdiction of the United States to take a listed species, where “take” means to harass, harm, pursue, hunt, shoot, wound, kill, trap, capture, or collect, or to attempt to engage in any such conduct. The word “harm” in the definition of “take” means an act which actually kills or injures wildlife. Such an act may include significant habitat modification or degradation where it actually kills or injures wildlife by significantly impairing essential behavioral patterns, including breeding, feeding or sheltering.

(f) If the non-federal permittee has a valid ESA section 10(a)(1)(B) incidental take permit with an approved Habitat Conservation Plan for a project or a group of projects that includes the proposed NWP activity, the non-federal applicant should provide a copy of that ESA section 10(a)(1)(B) permit with the PCN required by paragraph (c) of this general condition. The district engineer will coordinate with the agency that issued the ESA section 10(a)(1)(B) permit to determine whether the proposed NWP activity and the associated incidental take were considered in the internal ESA section 7 consultation conducted for the ESA section 10(a)(1)(B) permit. If that coordination results in concurrence from the agency that the proposed NWP activity and the associated incidental take were considered in the internal ESA section 7 consultation for the ESA section 10(a)(1)(B) permit, the district engineer does not need to conduct a separate ESA section 7 consultation for the proposed NWP activity. The district engineer will notify the non-federal applicant within 45 days of receipt of a complete pre-construction notification whether the ESA section 10(a)(1)(B) permit covers the proposed NWP activity or whether additional ESA section 7 consultation is required.

(g) Information on the location of threatened and endangered species and their critical habitat can be obtained directly from the offices of the FWS and NMFS or their world wide web pages at <http://www.fws.gov/> or <http://www.fws.gov/ipac> and <http://www.nmfs.noaa.gov/pr/species/esa/> respectively.

19. Migratory Birds and Bald and Golden Eagles. The permittee is responsible for ensuring their action complies with the Migratory Bird Treaty Act and the Bald and Golden Eagle Protection Act. The permittee is responsible for contacting appropriate local office of the U.S. Fish and Wildlife Service to determine applicable measures to reduce impacts to migratory

birds or eagles, including whether “incidental take” permits are necessary and available under the Migratory Bird Treaty Act or Bald and Golden Eagle Protection Act for a particular activity.

20. Historic Properties. (a) In cases where the district engineer determines that the activity may have the potential to cause effects to properties listed, or eligible for listing, in the National Register of Historic Places, the activity is not authorized, until the requirements of Section 106 of the National Historic Preservation Act (NHPA) have been satisfied.

(b) Federal permittees should follow their own procedures for complying with the requirements of section 106 of the National Historic Preservation Act. If pre-construction notification is required for the proposed NWP activity, the Federal permittee must provide the district engineer with the appropriate documentation to demonstrate compliance with those requirements. The district engineer will verify that the appropriate documentation has been submitted. If the appropriate documentation is not submitted, then additional consultation under section 106 may be necessary. The respective federal agency is responsible for fulfilling its obligation to comply with section 106.

* (c) Non-federal permittees must submit a pre-construction notification to the district engineer if the NWP activity might have the potential to cause effects to any historic properties listed on, determined to be eligible for listing on, or potentially eligible for listing on the National Register of Historic Places, including previously unidentified properties. For such activities, the pre-construction notification must state which historic properties might have the potential to be affected by the proposed NWP activity or include a vicinity map indicating the location of the historic properties or the potential for the presence of historic properties. Assistance regarding information on the location of, or potential for, the presence of historic properties can be sought from the State Historic Preservation Officer, Tribal Historic Preservation Officer, or designated tribal representative, as appropriate, and the National Register of Historic Places (see 33 CFR 330.4(g)). When reviewing pre-construction notifications, district engineers will comply with the current procedures for addressing the requirements of section 106 of the National Historic Preservation Act. The district engineer shall make a reasonable and good faith effort to carry out appropriate identification efforts, which may include background research, consultation, oral history interviews, sample field investigation, and field survey. Based on the information submitted in the PCN and these identification efforts, the district engineer shall determine whether the proposed NWP activity has the potential to cause effects on the historic properties. Section 106 consultation is not required when the district engineer determines that the activity does not have the potential to cause effects on historic properties (see 36 CFR 800.3(a)). Section 106 consultation is required when the district engineer determines that the activity has the potential to cause effects on historic properties. The district engineer will conduct consultation with consulting parties identified under 36 CFR 800.2(c) when he or she makes any of the following effect determinations for the purposes of section 106 of the NHPA: no historic properties affected, no adverse effect, or adverse effect. Where the non-Federal applicant has identified historic properties on which the activity might have the potential to cause effects and so notified the Corps, the non-Federal applicant shall not begin the activity until notified by the district engineer either that the activity has no potential to cause effects to historic properties or that NHPA section 106 consultation has been completed.

(d) For non-federal permittees, the district engineer will notify the prospective permittee within 45 days of receipt of a complete pre-construction notification whether NHPA section 106 consultation is required. If NHPA section 106 consultation is required, the district engineer will notify the non-Federal applicant that he or she cannot begin the activity until section 106 consultation is completed. If the non-Federal applicant has not heard back from the Corps within 45 days, the applicant must still wait for notification from the Corps.

(e) Prospective permittees should be aware that section 110k of the NHPA (54 U.S.C. 306113) prevents the Corps from granting a permit or other assistance to an applicant who, with intent to avoid the requirements of section 106 of the NHPA, has intentionally significantly adversely affected a historic property to which the permit would relate, or having legal power to prevent it, allowed such significant adverse effect to occur, unless the Corps, after consultation with the Advisory Council on Historic Preservation (ACHP), determines that circumstances justify granting such assistance despite the adverse effect created or permitted by the applicant. If circumstances justify granting the assistance, the Corps is required to notify the ACHP and provide documentation specifying the circumstances, the degree of damage to the integrity of any historic properties affected, and proposed mitigation. This documentation must include any views obtained from the applicant, SHPO/THPO, appropriate Indian tribes if the undertaking occurs on or affects historic properties on tribal lands or affects properties of interest to those tribes, and other parties known to have a legitimate interest in the impacts to the permitted activity on historic properties.

21. Discovery of Previously Unknown Remains and Artifacts. If you discover any previously unknown historic, cultural or archeological remains and artifacts while accomplishing the activity authorized by this permit, you must immediately notify the district engineer of what you have found, and to the maximum extent practicable, avoid construction activities that may affect the remains and artifacts until the required coordination has been completed. The district engineer will initiate the Federal, Tribal, and state coordination required to determine if the items or remains warrant a recovery effort or if the site is eligible for listing in the National Register of Historic Places.

22. Designated Critical Resource Waters. Critical resource waters include, NOAA-managed marine sanctuaries and marine monuments, and National Estuarine Research Reserves. The district engineer may designate, after notice and opportunity for public comment, additional waters officially designated by a state as having particular environmental or ecological significance, such as outstanding national resource waters or state natural heritage sites. The district engineer may also designate additional critical resource waters after notice and opportunity for public comment.

(a) Discharges of dredged or fill material into waters of the United States are not authorized by NWPs 7, 12, 14, 16, 17, 21, 29, 31, 35, 39, 40, 42, 43, 44, 49, 50, 51, and 52 for any activity within, or directly affecting, critical resource waters, including wetlands adjacent to such waters.

(b) For NWPs 3, 8, 10, 13, 15, 18, 19, 22, 23, 25, 27, 28, 30, 33, 34, 36, 37, 38, and 54, notification is required in accordance with general condition 32, for any activity proposed in the designated critical resource waters including wetlands adjacent to those waters. The district engineer may authorize activities under these NWPs only after it is determined that the impacts to the critical resource waters will be no more than minimal.

23. Mitigation. The district engineer will consider the following factors when determining appropriate and practicable mitigation necessary to ensure that the individual and cumulative adverse environmental effects are no more than minimal:

(a) The activity must be designed and constructed to avoid and minimize adverse effects, both temporary and permanent, to waters of the United States to the maximum extent practicable at the project site (i.e., on site).

(b) Mitigation in all its forms (avoiding, minimizing, rectifying, reducing, or compensating for resource losses) will be required to the extent necessary to ensure that the individual and cumulative adverse environmental effects are no more than minimal.

(c) Compensatory mitigation at a minimum one-for-one ratio will be required for all wetland losses that exceed 1/10-acre and require pre-construction notification, unless the district engineer determines in writing that either some other form of mitigation would be more environmentally appropriate or the adverse environmental effects of the proposed activity are no more than minimal, and provides an activity-specific waiver of this requirement. For wetland losses of 1/10-acre or less that require pre-construction notification, the district engineer may determine on a case-by-case basis that compensatory mitigation is required to ensure that the activity results in only minimal adverse environmental effects.

(d) For losses of streams or other open waters that require pre-construction notification, the district engineer may require compensatory mitigation to ensure that the activity results in no more than minimal adverse environmental effects. Compensatory mitigation for losses of streams should be provided, if practicable, through stream rehabilitation, enhancement, or preservation, since streams are difficult-to-replace resources (see 33 CFR 332.3(e)(3)).

(e) Compensatory mitigation plans for NWP activities in or near streams or other open waters will normally include a requirement for the restoration or enhancement, maintenance, and legal protection (e.g., conservation easements) of riparian areas next to open waters. In some cases, the restoration or maintenance/protection of riparian areas may be the only compensatory mitigation required. Restored riparian areas should consist of native species. The width of the required riparian area will address documented water quality or aquatic habitat loss concerns. Normally, the riparian area will be 25 to 50 feet wide on each side of the stream, but the district engineer may require slightly wider riparian areas to address documented water quality or habitat loss concerns. If it is not possible to restore or maintain/protect a riparian area on both sides of a stream, or if the waterbody is a lake or coastal waters, then restoring or maintaining/protecting a riparian area along a single bank or shoreline may be sufficient. Where both wetlands and open waters exist on the project site, the district engineer will determine the appropriate compensatory mitigation (e.g., riparian areas and/or wetlands compensation) based on what is best for the aquatic environment on a watershed basis. In cases where riparian areas are determined to be the most appropriate form of minimization or compensatory mitigation, the district engineer may waive or reduce the requirement to provide wetland compensatory mitigation for wetland losses.

(f) Compensatory mitigation projects provided to offset losses of aquatic resources must comply with the applicable provisions of 33 CFR part 332.

(1) The prospective permittee is responsible for proposing an appropriate compensatory mitigation option if compensatory mitigation is necessary to ensure that the activity results in no more than minimal adverse environmental effects. For the NWPs, the preferred mechanism for providing compensatory mitigation is mitigation bank credits or in-

lieu fee program credits (see 33 CFR 332.3(b)(2) and (3)). However, if an appropriate number and type of mitigation bank or in-lieu credits are not available at the time the PCN is submitted to the district engineer, the district engineer may approve the use of permittee-responsible mitigation.

(2) The amount of compensatory mitigation required by the district engineer must be sufficient to ensure that the authorized activity results in no more than minimal individual and cumulative adverse environmental effects (see 33 CFR 330.1(e)(3)). (See also 33 CFR 332.3(f)).

(3) Since the likelihood of success is greater and the impacts to potentially valuable uplands are reduced, aquatic resource restoration should be the first compensatory mitigation option considered for permittee-responsible mitigation.

(4) If permittee-responsible mitigation is the proposed option, the prospective permittee is responsible for submitting a mitigation plan. A conceptual or detailed mitigation plan may be used by the district engineer to make the decision on the NWP verification request, but a final mitigation plan that addresses the applicable requirements of 33 CFR 332.4(c)(2) through (14) must be approved by the district engineer before the permittee begins work in waters of the United States, unless the district engineer determines that prior approval of the final mitigation plan is not practicable or not necessary to ensure timely completion of the required compensatory mitigation (see 33 CFR 332.3(k)(3)).

(5) If mitigation bank or in-lieu fee program credits are the proposed option, the mitigation plan only needs to address the baseline conditions at the impact site and the number of credits to be provided.

(6) Compensatory mitigation requirements (e.g., resource type and amount to be provided as compensatory mitigation, site protection, ecological performance standards, monitoring requirements) may be addressed through conditions added to the NWP authorization, instead of components of a compensatory mitigation plan (see 33 CFR 332.4(c)(1)(ii)).

(g) Compensatory mitigation will not be used to increase the acreage losses allowed by the acreage limits of the NWPs. For example, if an NWP has an acreage limit of 1/2-acre, it cannot be used to authorize any NWP activity resulting in the loss of greater than 1/2-acre of waters of the United States, even if compensatory mitigation is provided that replaces or restores some of the lost waters. However, compensatory mitigation can and should be used, as necessary, to ensure that an NWP activity already meeting the established acreage limits also satisfies the no more than minimal impact requirement for the NWPs.

(h) Permittees may propose the use of mitigation banks, in-lieu fee programs, or permittee-responsible mitigation. When developing a compensatory mitigation proposal, the permittee must consider appropriate and practicable options consistent with the framework at 33 CFR 332.3(b). For activities resulting in the loss of marine or estuarine resources, permittee-responsible mitigation may be environmentally preferable if there are no mitigation banks or in-lieu fee programs in the area that have marine or estuarine credits available for sale or transfer to the permittee. For permittee-responsible mitigation, the special conditions of the NWP verification must clearly indicate the party or parties responsible for the implementation and performance of the compensatory mitigation project, and, if required, its long-term management.

(i) Where certain functions and services of waters of the United States are permanently adversely affected by a regulated activity, such as discharges of dredged or fill

material into waters of the United States that will convert a forested or scrub-shrub wetland to a herbaceous wetland in a permanently maintained utility line right-of-way, mitigation may be required to reduce the adverse environmental effects of the activity to the no more than minimal level.

24. Safety of Impoundment Structures. To ensure that all impoundment structures are safely designed, the district engineer may require non-Federal applicants to demonstrate that the structures comply with established state dam safety criteria or have been designed by qualified persons. The district engineer may also require documentation that the design has been independently reviewed by similarly qualified persons, and appropriate modifications made to ensure safety.

25. Water Quality. Where States and authorized Tribes, or EPA where applicable, have not previously certified compliance of an NWP with CWA section 401, individual 401 Water Quality Certification must be obtained or waived (see 33 CFR 330.4(c)). The district engineer or State or Tribe may require additional water quality management measures to ensure that the authorized activity does not result in more than minimal degradation of water quality.

26. Coastal Zone Management. In coastal states where an NWP has not previously received a state coastal zone management consistency concurrence, an individual state coastal zone management consistency concurrence must be obtained, or a presumption of concurrence must occur (see 33 CFR 330.4(d)). The district engineer or a State may require additional measures to ensure that the authorized activity is consistent with state coastal zone management requirements.

27. Regional and Case-By-Case Conditions. The activity must comply with any regional conditions that may have been added by the Division Engineer (see 33 CFR 330.4(e)) and with any case specific conditions added by the Corps or by the state, Indian Tribe, or U.S. EPA in its section 401 Water Quality Certification, or by the state in its Coastal Zone Management Act consistency determination.

28. Use of Multiple Nationwide Permits. The use of more than one NWP for a single and complete project is prohibited, except when the acreage loss of waters of the United States authorized by the NWPs does not exceed the acreage limit of the NWP with the highest specified acreage limit. For example, if a road crossing over tidal waters is constructed under NWP 14, with associated bank stabilization authorized by NWP 13, the maximum acreage loss of waters of the United States for the total project cannot exceed 1/3-acre.

29. Transfer of Nationwide Permit Verifications. If the permittee sells the property associated with a nationwide permit verification, the permittee may transfer the nationwide permit verification to the new owner by submitting a letter to the appropriate Corps district office to validate the transfer. A copy of the nationwide permit verification must be attached to the letter, and the letter must contain the following statement and signature:
“When the structures or work authorized by this nationwide permit are still in existence at the time the property is transferred, the terms and conditions of this nationwide permit, including any special conditions, will continue to be binding on the new owner(s) of the property. To

validate the transfer of this nationwide permit and the associated liabilities associated with compliance with its terms and conditions, have the transferee sign and date below.”

(Transferee)

(Date)

*

30. Compliance Certification. Each permittee who receives an NWP verification letter from the Corps must provide a signed certification documenting completion of the authorized activity and implementation of any required compensatory mitigation. The success of any required permittee-responsible mitigation, including the achievement of ecological performance standards, will be addressed separately by the district engineer. The Corps will provide the permittee the certification document with the NWP verification letter. The certification document will include:

(a) A statement that the authorized activity was done in accordance with the NWP authorization, including any general, regional, or activity-specific conditions;

(b) A statement that the implementation of any required compensatory mitigation was completed in accordance with the permit conditions. If credits from a mitigation bank or in-lieu fee program are used to satisfy the compensatory mitigation requirements, the certification must include the documentation required by 33 CFR 332.3(l)(3) to confirm that the permittee secured the appropriate number and resource type of credits; and

(c) The signature of the permittee certifying the completion of the activity and mitigation.

The completed certification document must be submitted to the district engineer within 30 days of completion of the authorized activity or the implementation of any required compensatory mitigation, whichever occurs later.

*

31. Activities Affecting Structures or Works Built by the United States. If an NWP activity also requires permission from the Corps pursuant to 33 U.S.C. 408 because it will alter or temporarily or permanently occupy or use a U.S. Army Corps of Engineers (USACE) federally authorized Civil Works project (a “USACE project”), the prospective permittee must submit a pre-construction notification. See paragraph (b)(10) of general condition 32. An activity that requires section 408 permission is not authorized by NWP until the appropriate Corps office issues the section 408 permission to alter, occupy, or use the USACE project, and the district engineer issues a written NWP verification.

*

32. Pre-Construction Notification. (a) Timing. Where required by the terms of the NWP, the prospective permittee must notify the district engineer by submitting a pre-construction notification (PCN) as early as possible. The district engineer must determine if the PCN is complete within 30 calendar days of the date of receipt and, if the PCN is determined to be incomplete, notify the prospective permittee within that 30 day period to request the additional information necessary to make the PCN complete. The request must specify the information needed to make the PCN complete. As a general rule, district engineers will request additional information necessary to make the PCN complete only once. However, if the

prospective permittee does not provide all of the requested information, then the district engineer will notify the prospective permittee that the PCN is still incomplete and the PCN review process will not commence until all of the requested information has been received by the district engineer. The prospective permittee shall not begin the activity until either:

(1) He or she is notified in writing by the district engineer that the activity may proceed under the NWP with any special conditions imposed by the district or division engineer; or

(2) 45 calendar days have passed from the district engineer's receipt of the complete PCN and the prospective permittee has not received written notice from the district or division engineer. However, if the permittee was required to notify the Corps pursuant to general condition 18 that listed species or critical habitat might be affected or are in the vicinity of the activity, or to notify the Corps pursuant to general condition 20 that the activity might have the potential to cause effects to historic properties, the permittee cannot begin the activity until receiving written notification from the Corps that there is "no effect" on listed species or "no potential to cause effects" on historic properties, or that any consultation required under Section 7 of the Endangered Species Act (see 33 CFR 330.4(f)) and/or section 106 of the National Historic Preservation Act (see 33 CFR 330.4(g)) has been completed. Also, work cannot begin under NWPs 21, 49, or 50 until the permittee has received written approval from the Corps. If the proposed activity requires a written waiver to exceed specified limits of an NWP, the permittee may not begin the activity until the district engineer issues the waiver. If the district or division engineer notifies the permittee in writing that an individual permit is required within 45 calendar days of receipt of a complete PCN, the permittee cannot begin the activity until an individual permit has been obtained. Subsequently, the permittee's right to proceed under the NWP may be modified, suspended, or revoked only in accordance with the procedure set forth in 33 CFR 330.5(d)(2).

(b) Contents of Pre-Construction Notification: The PCN must be in writing and include the following information:

(1) Name, address and telephone numbers of the prospective permittee;

(2) Location of the proposed activity;

(3) Identify the specific NWP or NWP(s) the prospective permittee wants to use to authorize the proposed activity;

(4) A description of the proposed activity; the activity's purpose; direct and indirect adverse environmental effects the activity would cause, including the anticipated amount of loss of wetlands, other special aquatic sites, and other waters expected to result from the NWP activity, in acres, linear feet, or other appropriate unit of measure; a description of any proposed mitigation measures intended to reduce the adverse environmental effects caused by the proposed activity; and any other NWP(s), regional general permit(s), or individual permit(s) used or intended to be used to authorize any part of the proposed project or any related activity, including other separate and distant crossings for linear projects that require Department of the Army authorization but do not require pre-construction notification. The description of the proposed activity and any proposed mitigation measures should be sufficiently detailed to allow the district engineer to determine that the adverse environmental effects of the activity will be no more than minimal and to determine the need for compensatory mitigation or other mitigation measures. For single and complete linear projects, the PCN must include the quantity of anticipated losses of wetlands, other special aquatic sites, and other waters for each single and complete crossing of those wetlands, other special aquatic sites, and other waters.

Sketches should be provided when necessary to show that the activity complies with the terms of the NWP. (Sketches usually clarify the activity and when provided results in a quicker decision. Sketches should contain sufficient detail to provide an illustrative description of the proposed activity (e.g., a conceptual plan), but do not need to be detailed engineering plans);

(5) The PCN must include a delineation of wetlands, other special aquatic sites, and other waters, such as lakes and ponds, and perennial, intermittent, and ephemeral streams, on the project site. Wetland delineations must be prepared in accordance with the current method required by the Corps. The permittee may ask the Corps to delineate the special aquatic sites and other waters on the project site, but there may be a delay if the Corps does the delineation, especially if the project site is large or contains many wetlands, other special aquatic sites, and other waters. Furthermore, the 45 day period will not start until the delineation has been submitted to or completed by the Corps, as appropriate;

(6) If the proposed activity will result in the loss of greater than 1/10-acre of wetlands and a PCN is required, the prospective permittee must submit a statement describing how the mitigation requirement will be satisfied, or explaining why the adverse environmental effects are no more than minimal and why compensatory mitigation should not be required. As an alternative, the prospective permittee may submit a conceptual or detailed mitigation plan.

(7) For non-Federal permittees, if any listed species or designated critical habitat might be affected or is in the vicinity of the activity, or if the activity is located in designated critical habitat, the PCN must include the name(s) of those endangered or threatened species that might be affected by the proposed activity or utilize the designated critical habitat that might be affected by the proposed activity. For NWP activities that require pre-construction notification, Federal permittees must provide documentation demonstrating compliance with the Endangered Species Act;

(8) For non-Federal permittees, if the NWP activity might have the potential to cause effects to a historic property listed on, determined to be eligible for listing on, or potentially eligible for listing on, the National Register of Historic Places, the PCN must state which historic property might have the potential to be affected by the proposed activity or include a vicinity map indicating the location of the historic property. For NWP activities that require pre-construction notification, Federal permittees must provide documentation demonstrating compliance with section 106 of the National Historic Preservation Act;

(9) For an activity that will occur in a component of the National Wild and Scenic River System, or in a river officially designated by Congress as a “study river” for possible inclusion in the system while the river is in an official study status, the PCN must identify the Wild and Scenic River or the “study river” (see general condition 16); and

(10) For an activity that requires permission from the Corps pursuant to 33 U.S.C. 408 because it will alter or temporarily or permanently occupy or use a U.S. Army Corps of Engineers federally authorized civil works project, the pre-construction notification must include a statement confirming that the project proponent has submitted a written request for section 408 permission from the Corps office having jurisdiction over that USACE project.

(c) Form of Pre-Construction Notification: The standard individual permit application form (Form ENG 4345) may be used, but the completed application form must clearly indicate that it is an NWP PCN and must include all of the applicable information required in paragraphs (b)(1) through (10) of this general condition. A letter containing the required information may also be used. Applicants may provide electronic files of PCNs and

supporting materials if the district engineer has established tools and procedures for electronic submittals.

(d) Agency Coordination: (1) The district engineer will consider any comments from Federal and state agencies concerning the proposed activity's compliance with the terms and conditions of the NWP's and the need for mitigation to reduce the activity's adverse environmental effects so that they are no more than minimal.

(2) Agency coordination is required for: (i) all NWP activities that require pre-construction notification and result in the loss of greater than 1/2-acre of waters of the United States; (ii) NWP 21, 29, 39, 40, 42, 43, 44, 50, 51, and 52 activities that require pre-construction notification and will result in the loss of greater than 300 linear feet of stream bed; (iii) NWP 13 activities in excess of 500 linear feet, fills greater than one cubic yard per running foot, or involve discharges of dredged or fill material into special aquatic sites; and (iv) NWP 54 activities in excess of 500 linear feet, or that extend into the waterbody more than 30 feet from the mean low water line in tidal waters or the ordinary high water mark in the Great Lakes.

(3) When agency coordination is required, the district engineer will immediately provide (e.g., via e-mail, facsimile transmission, overnight mail, or other expeditious manner) a copy of the complete PCN to the appropriate Federal or state offices (FWS, state natural resource or water quality agency, EPA, and, if appropriate, the NMFS). With the exception of NWP 37, these agencies will have 10 calendar days from the date the material is transmitted to notify the district engineer via telephone, facsimile transmission, or e-mail that they intend to provide substantive, site-specific comments. The comments must explain why the agency believes the adverse environmental effects will be more than minimal. If so contacted by an agency, the district engineer will wait an additional 15 calendar days before making a decision on the pre-construction notification. The district engineer will fully consider agency comments received within the specified time frame concerning the proposed activity's compliance with the terms and conditions of the NWP's, including the need for mitigation to ensure the net adverse environmental effects of the proposed activity are no more than minimal. The district engineer will provide no response to the resource agency, except as provided below. The district engineer will indicate in the administrative record associated with each pre-construction notification that the resource agencies' concerns were considered. For NWP 37, the emergency watershed protection and rehabilitation activity may proceed immediately in cases where there is an unacceptable hazard to life or a significant loss of property or economic hardship will occur. The district engineer will consider any comments received to decide whether the NWP 37 authorization should be modified, suspended, or revoked in accordance with the procedures at 33 CFR 330.5.

(4) In cases of where the prospective permittee is not a Federal agency, the district engineer will provide a response to NMFS within 30 calendar days of receipt of any Essential Fish Habitat conservation recommendations, as required by section 305(b)(4)(B) of the Magnuson-Stevens Fishery Conservation and Management Act.

(5) Applicants are encouraged to provide the Corps with either electronic files or multiple copies of pre-construction notifications to expedite agency coordination.

DISTRICT ENGINEER'S DECISION

1. In reviewing the PCN for the proposed activity, the district engineer will determine whether the activity authorized by the NWP will result in more than minimal

individual or cumulative adverse environmental effects or may be contrary to the public interest. If a project proponent requests authorization by a specific NWP, the district engineer should issue the NWP verification for that activity if it meets the terms and conditions of that NWP, unless he or she determines, after considering mitigation, that the proposed activity will result in more than minimal individual and cumulative adverse effects on the aquatic environment and other aspects of the public interest and exercises discretionary authority to require an individual permit for the proposed activity. For a linear project, this determination will include an evaluation of the individual crossings of waters of the United States to determine whether they individually satisfy the terms and conditions of the NWP(s), as well as the cumulative effects caused by all of the crossings authorized by NWP. If an applicant requests a waiver of the 300 linear foot limit on impacts to streams or of an otherwise applicable limit, as provided for in NWPs 13, 21, 29, 36, 39, 40, 42, 43, 44, 50, 51, 52, or 54, the district engineer will only grant the waiver upon a written determination that the NWP activity will result in only minimal individual and cumulative adverse environmental effects. For those NWPs that have a waivable 300 linear foot limit for losses of intermittent and ephemeral stream bed and a 1/2-acre limit (i.e., NWPs 21, 29, 39, 40, 42, 43, 44, 50, 51, and 52), the loss of intermittent and ephemeral stream bed, plus any other losses of jurisdictional waters and wetlands, cannot exceed 1/2-acre.

2. When making minimal adverse environmental effects determinations the district engineer will consider the direct and indirect effects caused by the NWP activity. He or she will also consider the cumulative adverse environmental effects caused by activities authorized by NWP and whether those cumulative adverse environmental effects are no more than minimal. The district engineer will also consider site specific factors, such as the environmental setting in the vicinity of the NWP activity, the type of resource that will be affected by the NWP activity, the functions provided by the aquatic resources that will be affected by the NWP activity, the degree or magnitude to which the aquatic resources perform those functions, the extent that aquatic resource functions will be lost as a result of the NWP activity (e.g., partial or complete loss), the duration of the adverse effects (temporary or permanent), the importance of the aquatic resource functions to the region (e.g., watershed or ecoregion), and mitigation required by the district engineer. If an appropriate functional or condition assessment method is available and practicable to use, that assessment method may be used by the district engineer to assist in the minimal adverse environmental effects determination. The district engineer may add case-specific special conditions to the NWP authorization to address site-specific environmental concerns.

3. If the proposed activity requires a PCN and will result in a loss of greater than 1/10-acre of wetlands, the prospective permittee should submit a mitigation proposal with the PCN. Applicants may also propose compensatory mitigation for NWP activities with smaller impacts, or for impacts to other types of waters (e.g., streams). The district engineer will consider any proposed compensatory mitigation or other mitigation measures the applicant has included in the proposal in determining whether the net adverse environmental effects of the proposed activity are no more than minimal. The compensatory mitigation proposal may be either conceptual or detailed. If the district engineer determines that the activity complies with the terms and conditions of the NWP and that the adverse environmental effects are no more than minimal, after considering mitigation, the district engineer will notify the permittee and

include any activity-specific conditions in the NWP verification the district engineer deems necessary. Conditions for compensatory mitigation requirements must comply with the appropriate provisions at 33 CFR 332.3(k). The district engineer must approve the final mitigation plan before the permittee commences work in waters of the United States, unless the district engineer determines that prior approval of the final mitigation plan is not practicable or not necessary to ensure timely completion of the required compensatory mitigation. If the prospective permittee elects to submit a compensatory mitigation plan with the PCN, the district engineer will expeditiously review the proposed compensatory mitigation plan. The district engineer must review the proposed compensatory mitigation plan within 45 calendar days of receiving a complete PCN and determine whether the proposed mitigation would ensure the NWP activity results in no more than minimal adverse environmental effects. If the net adverse environmental effects of the NWP activity (after consideration of the mitigation proposal) are determined by the district engineer to be no more than minimal, the district engineer will provide a timely written response to the applicant. The response will state that the NWP activity can proceed under the terms and conditions of the NWP, including any activity-specific conditions added to the NWP authorization by the district engineer.

4. If the district engineer determines that the adverse environmental effects of the proposed activity are more than minimal, then the district engineer will notify the applicant either: (a) that the activity does not qualify for authorization under the NWP and instruct the applicant on the procedures to seek authorization under an individual permit; (b) that the activity is authorized under the NWP subject to the applicant's submission of a mitigation plan that would reduce the adverse environmental effects so that they are no more than minimal; or (c) that the activity is authorized under the NWP with specific modifications or conditions. Where the district engineer determines that mitigation is required to ensure no more than minimal adverse environmental effects, the activity will be authorized within the 45-day PCN period (unless additional time is required to comply with general conditions 18, 20, and/or 31, or to evaluate PCNs for activities authorized by NWPs 21, 49, and 50), with activity-specific conditions that state the mitigation requirements. The authorization will include the necessary conceptual or detailed mitigation plan or a requirement that the applicant submit a mitigation plan that would reduce the adverse environmental effects so that they are no more than minimal. When compensatory mitigation is required, no work in waters of the United States may occur until the district engineer has approved a specific mitigation plan or has determined that prior approval of a final mitigation plan is not practicable or not necessary to ensure timely completion of the required compensatory mitigation.

FURTHER INFORMATION

1. District Engineers have authority to determine if an activity complies with the terms and conditions of an NWP.
2. NWPs do not obviate the need to obtain other federal, state, or local permits, approvals, or authorizations required by law.
3. NWPs do not grant any property rights or exclusive privileges.
4. NWPs do not authorize any injury to the property or rights of others.
5. NWPs do not authorize interference with any existing or proposed Federal project (see general condition 31).

DEFINITIONS

Best management practices (BMPs): Policies, practices, procedures, or structures implemented to mitigate the adverse environmental effects on surface water quality resulting from development. BMPs are categorized as structural or non-structural.

Compensatory mitigation: The restoration (re-establishment or rehabilitation), establishment (creation), enhancement, and/or in certain circumstances preservation of aquatic resources for the purposes of offsetting unavoidable adverse impacts which remain after all appropriate and practicable avoidance and minimization has been achieved.

Currently serviceable: Useable as is or with some maintenance, but not so degraded as to essentially require reconstruction.

Direct effects: Effects that are caused by the activity and occur at the same time and place.

Discharge: The term “discharge” means any discharge of dredged or fill material into waters of the United States.

Ecological reference: A model used to plan and design an aquatic habitat and riparian area restoration, enhancement, or establishment activity under NWP 27. An ecological reference may be based on the structure, functions, and dynamics of an aquatic habitat type or a riparian area type that currently exists in the region where the proposed NWP 27 activity is located. Alternatively, an ecological reference may be based on a conceptual model for the aquatic habitat type or riparian area type to be restored, enhanced, or established as a result of the proposed NWP 27 activity. An ecological reference takes into account the range of variation of the aquatic habitat type or riparian area type in the region.

Enhancement: The manipulation of the physical, chemical, or biological characteristics of an aquatic resource to heighten, intensify, or improve a specific aquatic resource function(s). Enhancement results in the gain of selected aquatic resource function(s), but may also lead to a decline in other aquatic resource function(s). Enhancement does not result in a gain in aquatic resource area.

Ephemeral stream: An ephemeral stream has flowing water only during, and for a short duration after, precipitation events in a typical year. Ephemeral stream beds are located above the water table year-round. Groundwater is not a source of water for the stream. Runoff from rainfall is the primary source of water for stream flow.

Establishment (creation): The manipulation of the physical, chemical, or biological characteristics present to develop an aquatic resource that did not previously exist at an upland site. Establishment results in a gain in aquatic resource area.

High Tide Line: The line of intersection of the land with the water’s surface at the maximum height reached by a rising tide. The high tide line may be determined, in the absence of actual data, by a line of oil or scum along shore objects, a more or less continuous deposit of fine shell or debris on the foreshore or berm, other physical markings or characteristics, vegetation lines, tidal gages, or other suitable means that delineate the general height reached by a rising tide. The line encompasses spring high tides and other high tides that occur with periodic frequency but does not include storm surges in which there is a departure from the normal or predicted reach of the tide due to the piling up of water against a coast by strong winds such as those accompanying a hurricane or other intense storm.

Historic Property: Any prehistoric or historic district, site (including archaeological site), building, structure, or other object included in, or eligible for inclusion in, the National

Register of Historic Places maintained by the Secretary of the Interior. This term includes artifacts, records, and remains that are related to and located within such properties. The term includes properties of traditional religious and cultural importance to an Indian tribe or Native Hawaiian organization and that meet the National Register criteria (36 CFR part 60).

Independent utility: A test to determine what constitutes a single and complete non-linear project in the Corps Regulatory Program. A project is considered to have independent utility if it would be constructed absent the construction of other projects in the project area. Portions of a multi-phase project that depend upon other phases of the project do not have independent utility. Phases of a project that would be constructed even if the other phases were not built can be considered as separate single and complete projects with independent utility.

Indirect effects: Effects that are caused by the activity and are later in time or farther removed in distance, but are still reasonably foreseeable.

Intermittent stream: An intermittent stream has flowing water during certain times of the year, when groundwater provides water for stream flow. During dry periods, intermittent streams may not have flowing water. Runoff from rainfall is a supplemental source of water for stream flow.

Loss of waters of the United States: Waters of the United States that are permanently adversely affected by filling, flooding, excavation, or drainage because of the regulated activity. Permanent adverse effects include permanent discharges of dredged or fill material that change an aquatic area to dry land, increase the bottom elevation of a waterbody, or change the use of a waterbody. The acreage of loss of waters of the United States is a threshold measurement of the impact to jurisdictional waters for determining whether a project may qualify for an NWP; it is not a net threshold that is calculated after considering compensatory mitigation that may be used to offset losses of aquatic functions and services. The loss of stream bed includes the acres or linear feet of stream bed that are filled or excavated as a result of the regulated activity. Waters of the United States temporarily filled, flooded, excavated, or drained, but restored to pre-construction contours and elevations after construction, are not included in the measurement of loss of waters of the United States. Impacts resulting from activities that do not require Department of the Army authorization, such as activities eligible for exemptions under section 404(f) of the Clean Water Act, are not considered when calculating the loss of waters of the United States.

Navigable waters: Waters subject to section 10 of the Rivers and Harbors Act of 1899. These waters are defined at 33 CFR part 329.

Non-tidal wetland: A non-tidal wetland is a wetland that is not subject to the ebb and flow of tidal waters. Non-tidal wetlands contiguous to tidal waters are located landward of the high tide line (i.e., spring high tide line).

Open water: For purposes of the NWPs, an open water is any area that in a year with normal patterns of precipitation has water flowing or standing above ground to the extent that an ordinary high water mark can be determined. Aquatic vegetation within the area of flowing or standing water is either non-emergent, sparse, or absent. Vegetated shallows are considered to be open waters. Examples of “open waters” include rivers, streams, lakes, and ponds.

Ordinary High Water Mark: An ordinary high water mark is a line on the shore established by the fluctuations of water and indicated by physical characteristics, or by other appropriate means that consider the characteristics of the surrounding areas.

Perennial stream: A perennial stream has flowing water year-round during a typical year. The water table is located above the stream bed for most of the year. Groundwater is the

primary source of water for stream flow. Runoff from rainfall is a supplemental source of water for stream flow.

Practicable: Available and capable of being done after taking into consideration cost, existing technology, and logistics in light of overall project purposes.

Pre-construction notification: A request submitted by the project proponent to the Corps for confirmation that a particular activity is authorized by nationwide permit. The request may be a permit application, letter, or similar document that includes information about the proposed work and its anticipated environmental effects. Pre-construction notification may be required by the terms and conditions of a nationwide permit, or by regional conditions. A pre-construction notification may be voluntarily submitted in cases where pre-construction notification is not required and the project proponent wants confirmation that the activity is authorized by nationwide permit.

Preservation: The removal of a threat to, or preventing the decline of, aquatic resources by an action in or near those aquatic resources. This term includes activities commonly associated with the protection and maintenance of aquatic resources through the implementation of appropriate legal and physical mechanisms. Preservation does not result in a gain of aquatic resource area or functions.

Protected tribal resources: Those natural resources and properties of traditional or customary religious or cultural importance, either on or off Indian lands, retained by, or reserved by or for, Indian tribes through treaties, statutes, judicial decisions, or executive orders, including tribal trust resources.

Re-establishment: The manipulation of the physical, chemical, or biological characteristics of a site with the goal of returning natural/historic functions to a former aquatic resource. Re-establishment results in rebuilding a former aquatic resource and results in a gain in aquatic resource area and functions.

Rehabilitation: The manipulation of the physical, chemical, or biological characteristics of a site with the goal of repairing natural/historic functions to a degraded aquatic resource. Rehabilitation results in a gain in aquatic resource function, but does not result in a gain in aquatic resource area.

Restoration: The manipulation of the physical, chemical, or biological characteristics of a site with the goal of returning natural/historic functions to a former or degraded aquatic resource. For the purpose of tracking net gains in aquatic resource area, restoration is divided into two categories: re-establishment and rehabilitation.

Riffle and pool complex: Riffle and pool complexes are special aquatic sites under the 404(b)(1) Guidelines. Riffle and pool complexes sometimes characterize steep gradient sections of streams. Such stream sections are recognizable by their hydraulic characteristics. The rapid movement of water over a coarse substrate in riffles results in a rough flow, a turbulent surface, and high dissolved oxygen levels in the water. Pools are deeper areas associated with riffles. A slower stream velocity, a streaming flow, a smooth surface, and a finer substrate characterize pools.

Riparian areas: Riparian areas are lands next to streams, lakes, and estuarine- marine shorelines. Riparian areas are transitional between terrestrial and aquatic ecosystems, through which surface and subsurface hydrology connects riverine, lacustrine, estuarine, and marine waters with their adjacent wetlands, non-wetland waters, or uplands. Riparian areas provide a variety of ecological functions and services and help improve or maintain local water quality. (See general condition 23.)

Shellfish seeding: The placement of shellfish seed and/or suitable substrate to increase shellfish production. Shellfish seed consists of immature individual shellfish or individual shellfish attached to shells or shell fragments (i.e., spat on shell). Suitable substrate may consist of shellfish shells, shell fragments, or other appropriate materials placed into waters for shellfish habitat.

Single and complete linear project: A linear project is a project constructed for the purpose of getting people, goods, or services from a point of origin to a terminal point, which often involves multiple crossings of one or more waterbodies at separate and distant locations. The term “single and complete project” is defined as that portion of the total linear project proposed or accomplished by one owner/developer or partnership or other association of owners/developers that includes all crossings of a single water of the United States (i.e., a single waterbody) at a specific location. For linear projects crossing a single or multiple waterbodies several times at separate and distant locations, each crossing is considered a single and complete project for purposes of NWP authorization. However, individual channels in a braided stream or river, or individual arms of a large, irregularly shaped wetland or lake, etc., are not separate waterbodies, and crossings of such features cannot be considered separately.

Single and complete non-linear project: For non-linear projects, the term “single and complete project” is defined at 33 CFR 330.2(i) as the total project proposed or accomplished by one owner/developer or partnership or other association of owners/developers. A single and complete non-linear project must have independent utility (see definition of “independent utility”). Single and complete non-linear projects may not be “piecemealed” to avoid the limits in an NWP authorization.

Stormwater management: Stormwater management is the mechanism for controlling stormwater runoff for the purposes of reducing downstream erosion, water quality degradation, and flooding and mitigating the adverse effects of changes in land use on the aquatic environment.

Stormwater management facilities: Stormwater management facilities are those facilities, including but not limited to, stormwater retention and detention ponds and best management practices, which retain water for a period of time to control runoff and/or improve the quality (i.e., by reducing the concentration of nutrients, sediments, hazardous substances and other pollutants) of stormwater runoff.

Stream bed: The substrate of the stream channel between the ordinary high water marks. The substrate may be bedrock or inorganic particles that range in size from clay to boulders. Wetlands contiguous to the stream bed, but outside of the ordinary high water marks, are not considered part of the stream bed.

Stream channelization: The manipulation of a stream’s course, condition, capacity, or location that causes more than minimal interruption of normal stream processes. A channelized stream remains a water of the United States.

Structure: An object that is arranged in a definite pattern of organization. Examples of structures include, without limitation, any pier, boat dock, boat ramp, wharf, dolphin, weir, boom, breakwater, bulkhead, revetment, riprap, jetty, artificial island, artificial reef, permanent mooring structure, power transmission line, permanently moored floating vessel, piling, aid to navigation, or any other manmade obstacle or obstruction.

Tidal wetland: A tidal wetland is a jurisdictional wetland that is inundated by tidal waters. Tidal waters rise and fall in a predictable and measurable rhythm or cycle due to the gravitational pulls of the moon and sun. Tidal waters end where the rise and fall of the water

surface can no longer be practically measured in a predictable rhythm due to masking by other waters, wind, or other effects. Tidal wetlands are located channelward of the high tide line.

Tribal lands: Any lands title to which is either: 1) held in trust by the United States for the benefit of any Indian tribe or individual; or 2) held by any Indian tribe or individual subject to restrictions by the United States against alienation.

Tribal rights: Those rights legally accruing to a tribe or tribes by virtue of inherent sovereign authority, unextinguished aboriginal title, treaty, statute, judicial decisions, executive order or agreement, and that give rise to legally enforceable remedies.

Vegetated shallows: Vegetated shallows are special aquatic sites under the 404(b)(1) Guidelines. They are areas that are permanently inundated and under normal circumstances have rooted aquatic vegetation, such as seagrasses in marine and estuarine systems and a variety of vascular rooted plants in freshwater systems.

Waterbody: For purposes of the NWPs, a waterbody is a jurisdictional water of the United States. If a wetland is adjacent to a waterbody determined to be a water of the United States, that waterbody and any adjacent wetlands are considered together as a single aquatic unit (see 33 CFR 328.4(c)(2)). Examples of “waterbodies” include streams, rivers, lakes, ponds, and wetlands.

FINAL 2017 REGIONAL CONDITIONS

NOTICE ABOUT WEB LINKS IN THIS DOCUMENT:

The web links (both internal to our Wilmington District and any external links to collaborating agencies) in this document are valid at the time of publication. However, the Wilmington District Regulatory Program web page addresses, as with other agency web sites, may change over the timeframe of the five-year Nationwide Permit renewal cycle, in response to policy mandates or technology advances. While we will make every effort to check on the integrity of our web links and provide re-direct pages whenever possible, we ask that you report any broken links to us so we can keep the page information current and usable. We apologize in advanced for any broken links that you may encounter, and we ask that you navigate from the Regulatory home page (Regulatory Permit Program Wetlands and Streams) of the Wilmington District Corps of Engineers, to the “Permits” section of our web site to find links for pages that cannot be found by clicking directly on the listed web link in this document.

Final 2017 Regional Conditions for Nationwide Permits (NWP) in the Wilmington District

1.0 Excluded Waters

The Corps has identified waters that will be excluded from the use of all NWP’s during certain timeframes. These waters are:

1.1 Anadromous Fish Spawning Areas

Waters of the United States identified by either the North Carolina Division of Marine Fisheries (NCDMF) or the North Carolina Wildlife Resources Commission (NCWRC) as anadromous fish spawning areas are excluded during the period between February 15 and June 30, without prior written approval from the Corps and either NCDMF or NCWRC.

1.2 Trout Waters Moratorium

Waters of the United States in the designated trout watersheds of North Carolina are excluded during the period between October 15 and April 15 without prior written approval from the NCWRC, or from the Eastern Band of Cherokee Indians (EBCI) Fisheries and Wildlife Management (FWM) office if the project is located on EBCI trust land. (See Section 2.7 for information on the designated trout watersheds).

1.3 Sturgeon Spawning Areas as Designated by the National Marine Fisheries Service (NMFS)

Waters of the United States designated as sturgeon spawning areas are excluded during the period between February 1 and June 30, without prior written approval from the NMFS.

*** 2.0 Waters Requiring Additional Notification**

The Corps has identified waters that will be subject to additional notification requirements for activities authorized by all NWP's. These waters are:

*** 2.1 Western NC Counties that Drain to Designated Critical Habitat**

For proposed activities within waters of the United States that require a Pre-Construction Notification (PCN) and are located in the sixteen counties listed below, permittees must provide a copy of the PCN to the U.S. Fish and Wildlife Service (USFWS), 160 Zillicoa Street, Asheville, North Carolina 28801. This PCN must be sent concurrently to the U.S. Fish and Wildlife Service and the Corps Asheville Regulatory Field Office. Please see General Condition 18 for specific notification requirements related to the Endangered Species Act and the below website for information on the location of designated critical habitat.

Counties with tributaries that drain to designated critical habitat that require notification to the Asheville U.S. Fish and Wildlife Service: Avery, Cherokee, Forsyth, Graham, Haywood, Henderson, Jackson, Macon, Mecklenburg, Mitchell, Stokes, Surry, Swain, Transylvania, Union and Yancey.

Website and office addresses for Endangered Species Act Information:

The Wilmington District has developed the following website for permittees which provides guidelines on how to review linked websites and maps in order to fulfill NWP General Condition 18 requirements:

<http://www.saw.usace.army.mil/Missions/RegulatoryPermitProgram/AgencyCoordination/ESA.aspx>

Permittees who do not have internet access may contact the appropriate U.S. Fish and Wildlife Service offices listed below or Corps at (910) 251-4633:

Asheville U.S. Fish and Wildlife Service Office counties: All counties west of and including Anson, Stanly, Davidson, Forsythe and Stokes Counties.

U.S. Fish and Wildlife Service
Asheville Field Office
160 Zillicoa Street
Asheville, NC 28801
Telephone: (828) 258-3939

Raleigh U.S. Fish and Wildlife Service Office counties: all counties east of and including Richmond, Montgomery, Randolph, Guilford, and Rockingham Counties.

U.S. Fish and Wildlife Service
Raleigh Field Office
Post Office Box 33726

Raleigh, NC 27636-3726
Telephone: (919) 856-4520

* 2.2 Special Designation Waters

Prior to the use of any NWP, except NWP 3, that involves a discharge of dredged or fill material in any of the following identified waters and/or adjacent wetlands in North Carolina, permittees shall submit a PCN to the District Engineer prior to commencing the activity (see General Condition 32). The North Carolina waters and wetlands that require additional notification requirements are:

“Outstanding Resource Waters” (ORW) or “High Quality Waters” (HQW) as designated by the North Carolina Environmental Management Commission; “Primary Nursery Areas” (PNA), including inland PNA, as designated by the North Carolina Marine Fisheries Commission and the NCWRC; or wetlands adjacent to these waters. Definitions of ORW, HQW and PNA waters can be found in the North Carolina State Administrative Code, Title 15A, Subchapters 2B and 10C (15A NCAC 02B, 15A NCAC 10C) and at the following World Wide Web page:

<http://reports.oah.state.nc.us/ncac.asp?folderName=\Title%2015A%20-%20Environmental%20Quality&lookUpError=15A%20NCAC%20000%20>. Surface water classifications for waters in North Carolina can be viewed at the North Carolina Division of Water Resources website or at the following World Wide Web Page:

<https://deq.nc.gov/about/divisions/water-resources/planning/classification-standards/classifications>

Permittees who do not have internet access may contact the Corps at (910) 251- 4633.

2.3 Coastal Area Management Act (CAMA) Areas of Environmental Concern

Non-federal permittees for any NWP in a designated “Area of Environmental Concern” (AEC) in the twenty (20) counties of Eastern North Carolina covered by the North Carolina Coastal Area Management Act (CAMA) must also obtain the required CAMA permit. Development activities for non-federal projects may not commence until a copy of the approved CAMA permit is furnished to the appropriate Wilmington District Regulatory Field Office (Wilmington Field Office – 69 Darlington Avenue, Wilmington, NC 28403, (910) 251-4802 or Washington Field Office – 2407 West 5th Street, Washington, NC 27889, (910) 251-4610).

* 2.4 Barrier Islands

Prior to the use of any NWP on a barrier island of North Carolina, permittees must submit a PCN to the District Engineer prior to commencing the activity (see General Condition 32).

* 2.5 Mountain or Piedmont Bogs

Prior to the use of any NWP in a Bog, as classified by the North Carolina Wetland Assessment Methodology (NCWAM), permittees shall submit a PCN to the District Engineer prior to commencing the activity (see General Condition 32). The latest version of NCWAM can be

viewed on the Corps RIBITS (Regulatory In-lieu Fee and Bank Information Tracking System) website or at the following World Wide Web Page:

https://ribits.usace.army.mil/ribits_apex/f?p=107:27:0::NO::

*** 2.6 Animal Waste Facilities**

Prior to use of any NWP for construction of animal waste facilities in waters of the United States, including wetlands, permittees shall submit a PCN to the District Engineer prior to commencing the activity (see General Condition 32).

*** 2.7 Trout Waters**

Prior to any discharge of dredge or fill material into streams, waterbodies or wetlands within the 294 designated trout watersheds of North Carolina, the permittee shall submit a PCN (see General Condition 32) to the District Engineer prior to commencing the activity, unless other thresholds are established in the Regional Conditions in Section 4 (Additional Regional Conditions for Specific Nationwide Permits). The permittee shall also provide a copy of the notification to the appropriate NCWRC office, or to the EBCI FWM Office (if the project is located on EBCI trust land), to facilitate the determination of any potential impacts to designated Trout Waters.

Notification to the Corps will include a statement with the name of the NCWRC or EBCI FWM biologist contacted, the date of the notification, the location of work, a delineation of wetlands and waters, a discussion of alternatives to working in the mountain trout waters, why alternatives were not selected, and, if applicable, a plan to provide compensatory mitigation for all unavoidable adverse impacts to mountain trout waters.

NCWRC and NC Trout Watersheds:

NCWRC Contact**	Counties that are entirely within Trout Watersheds*	Counties that are partially within Trout Watersheds*
Mountain Coordinator Balsam Depot 20830 Great Smoky Mountain Expressway Waynesville, NC 28786 Telephone: (828) 558-6011 For NCDOT Projects: NCDOT Coordinator 206 Charter. Street Albemarle, NC 28001 Telephone: (704) 982-9181	Alleghany Jackson Ashe Macon Avery Swain Graham Transylvania Haywood Watauga	Burke McDowell Buncombe Mitchell Caldwell Polk Cherokee Rutherford Clay Surry Henderson Wilkes Madison Yancey

*NOTE: To determine notification requirements, contact the Corps Asheville Regulatory Field Office at (828) 271-7980 or view maps for each County at the following World Wide Web page: <http://www.saw.usace.army.mil/Missions/Regulatory-Permit-Program/Agency-Coordination/Trout/>.

**If a project is located on EBCI trust land, submit the PCN in accordance with Section 3.14. Contact the Corps Asheville Regulatory Field Office at (828) 271-7980 with questions.

* 2.8 Western NC Waters and Corridors

The permittee shall submit a PCN (see General Condition 32) to the District Engineer prior to commencing the activity in waters of the United States if the activity will occur within any of the following identified waters in western North Carolina, within 0.5 mile on either side of these waters, or within 0.75 mile of the Little Tennessee River, as measured from the top of the bank of the respective water (i.e., river, stream, or creek):

Brasstown Creek
Burningtown Creek
Cane River
Caney Fork
Cartoogechaye Creek
Chattooga River
Cheoah River
Cowee Creek
Cullasaja River
Deep Creek
Ellijay Creek
French Broad River
Garden Creek
Hiwassee River
Hominy Creek
Iotla Creek
Little Tennessee River (within the river or within 0.75 mile on either side of this river)
Nantahala River
Nolichucky River
North Fork French Broad River
North Toe River
Nottley River
Oconaluftee River (portion not located on trust/EBCI land)
Peachtree Creek
Shooting Creek
Snowbird Creek
South Toe River
Stecoah Creek
Swannanoa River
Sweetwater Creek

Tuckasegee River (also spelled Tuckaseegee or Tuckaseigee)
Valley River
Watauga Creek
Watauga River
Wayah Creek
West Fork French Broad River

To determine notification requirements, contact the Corps Asheville Regulatory Field Office at (828) 271-7980 or view maps for all corridors at the following World Wide Web page:

<http://www.saw.usace.army.mil/Missions/Regulatory-Permit-Program/Agency-Coordination/Designated-Special-Waters.aspx>

3.0 List of Corps Regional Conditions for All Nationwide Permits

The following conditions apply to all Nationwide Permits in the Wilmington District:

3.1 Limitation of Loss of Stream Bed

NWPs may not be used for activities that may result in the loss or degradation of more than 300 total linear feet of stream bed, unless the District Engineer has waived the 300 linear foot limit for ephemeral and intermittent streams on a case-by-case basis and has determined that the proposed activity will result in minimal individual and cumulative adverse impacts to the aquatic environment. Waivers for the loss of ephemeral and intermittent streams must be in writing and documented by appropriate/accepted stream quality assessments*. This waiver only applies to the 300 linear feet threshold for NWPs.

This Regional Condition does not apply to NWP 23 (Approved Categorical Exclusions).

*NOTE: Permittees should utilize the most current methodology prescribed by Wilmington District to assess stream function and quality. Information can be found at:

https://ribits.usace.army.mil/ribits_apex/f?p=107:27:0::NO::

3.2 Mitigation for Loss of Stream Bed

For any NWP that results in a loss of more than 150 linear feet of stream, the permittee shall provide a mitigation proposal to compensate for more than minimal individual and cumulative adverse impacts to the aquatic environment. For stream losses of 150 linear feet or less that require a PCN, the District Engineer may determine, on a case-by-case basis, that compensatory mitigation is required to ensure that the activity results in minimal adverse effect on the aquatic environment.

3.3 Pre-construction Notification for Loss of Streambed Exceeding 150 Feet

Prior to use of any NWP for any activity which impacts more than 150 total linear feet of perennial stream, intermittent or ephemeral stream, the permittee shall submit a PCN to the District Engineer prior to commencing the activity (see General Condition 32). This applies to

NWPs that do not have specific notification requirements. If a NWP has specific notification requirements, the requirements of the NWP should be followed.

3.4 Restriction on Use of Live Concrete

For all NWPs which allow the use of concrete as a building material, live or fresh concrete, including bags of uncured concrete, may not come into contact with the water in or entering into waters of the United States. Water inside coffer dams or casings that has been in contact with wet concrete shall only be returned to waters of the United States after the concrete is set and cured and when it no longer poses a threat to aquatic organisms.

3.5 Requirements for Using Riprap for Bank Stabilization

For all NWPs that allow for the use of riprap material for bank stabilization, the following measures shall be applied:

3.5.1. Where bank stabilization is conducted as part of an activity, natural design, bioengineering and/or geoengineering methods that incorporate natural durable materials, native seed mixes, and native plants and shrubs are to be utilized to the maximum extent practicable.

3.5.2. Filter cloth must be placed underneath the riprap as an additional requirement of its use in North Carolina waters. The placement of filter fabric is not required if the riprap will be pushed or “keyed” into the bank of the waterbody. A waiver from the specifications in this Regional Condition may be requested in writing. The waiver will only be issued if it can be demonstrated that the impacts of complying with this Regional Condition would result in greater adverse impacts to the aquatic environment.

3.5.3. The placement of riprap shall be limited to the areas depicted on submitted work plan drawings.

3.5.4. The riprap material shall be clean and free from loose dirt or any pollutant except in trace quantities that would not have an adverse environmental effect.

3.5.5. It shall be of a size sufficient to prevent its movement from the authorized alignment by natural forces under normal conditions.

3.5.6. The riprap material shall consist of clean rock or masonry material such as, but not limited to, granite, marl, or broken concrete.

3.6 Requirements for Culvert Placement

3.6.1 For all NWPs that involve the construction/installation of culverts, measures will be included in the construction/installation that will promote the safe passage of fish and other aquatic organisms. The dimension, pattern, and profile of the stream above and below a pipe or culvert should not be modified by altering the width or depth of the stream profile in connection with the construction activity. The width, height, and gradient of a proposed culvert should be

sufficient to pass the average historical low flow and spring flow without adversely altering flow velocity. Spring flow is the seasonal sustained high flow that typically occurs in the spring. Spring flows should be determined from gage data, if available. In the absence of such data, bank-full flow can be used as a comparable indicator.

In Public Trust Areas of Environmental Concern (AEC) and/or the Estuarine Waters AEC as designated by the Coastal Area Management Act (CAMA): All pipes/culverts must be sufficiently sized to allow for the burial of the bottom of the culvert at least one foot below normal bed elevation.

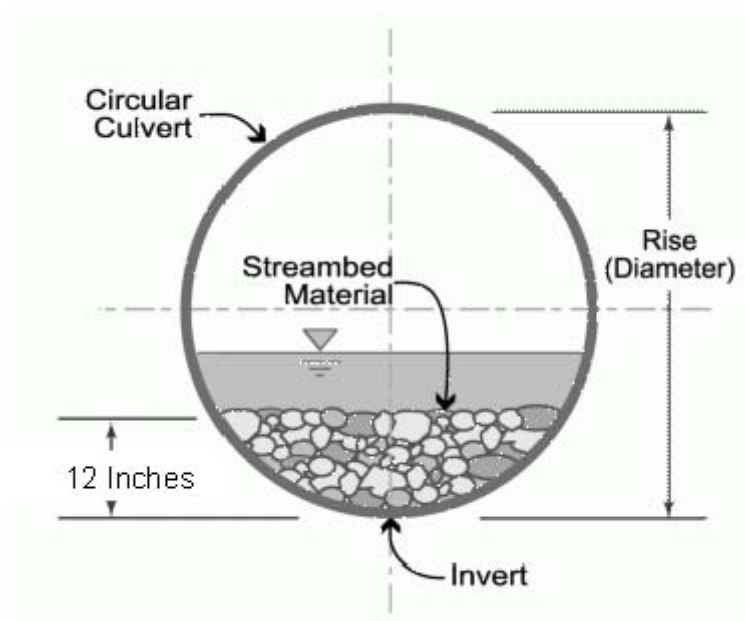

In all other areas: Culverts greater than 48 inches in diameter will be buried at least one foot below the bed of the stream. Culverts 48 inches in diameter or less shall be buried to maintain aquatic passage and to maintain passage during drought or low flow conditions, and every effort shall be made to maintain the existing channel slope.

Culverts must be designed and constructed in a manner that minimizes destabilization and head cutting. Destabilizing the channel and head cutting upstream should be considered and appropriate actions incorporated in the design and placement of the culvert.

A waiver from the depth specifications in this condition may be requested, in writing, by the permittee and issued by the Corp; this request must be specific as to the reasons(s) for the request. The waiver will be issued if it can be demonstrated that the proposed design would result in less impacts to the aquatic environment.

All counties: Culverts placed within riparian and/or riverine wetlands must be installed in a manner that does not restrict the flow and circulation patterns of waters of the United States.

Culverts placed across wetland fills purely for the purposes of equalizing surface water do not have to be buried, but the culverts must be of adequate size and/or number to ensure unrestricted transmission of water.

3.6.2 Bank-full flows (or less) shall be accommodated through maintenance of the existing bank-full channel cross sectional area. Additional culverts or culvert barrels at such crossings shall be allowed only to receive bank-full flows.

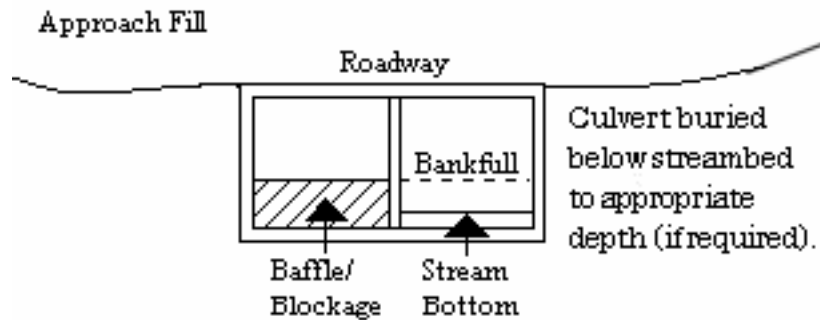

3.6.3 Where adjacent floodplain is available, flows exceeding bank-full should be accommodated by installing culverts at the floodplain elevation. Additional culverts or culvert barrels at such crossings should not be buried, or if buried, must have sills at the inlets to ensure that they only receive flows exceeding bank-full.

3.6.4 Excavation of existing stream channels shall be limited to the minimum necessary to construct or install the proposed culvert. The final width of the impacted stream at the culvert inlet and outlet should be no greater than the original stream width. A waiver from this condition may be requested in writing; this request must be specific as to the reason(s) for the request. The waiver will be issued if the proposed design would result in less impacts to the aquatic environment and/or if it can be demonstrated that it is not practicable to restore the final width of the impacted stream at the culvert inlet and outlet to the width of the original stream channel.

3.6.5 The width of the culvert shall be comparable to the width of the stream channel. If the width of the culvert is wider than the stream channel, the culvert shall include baffles, benches and/or sills to maintain the width of the stream channel. A waiver from this condition may be requested in writing; this request must be specific as to the reason(s) for the request. The waiver will be issued if it can be demonstrated that it is not practicable or necessary to include baffles, benches or sills and the design would result in less impacts to the aquatic environment.

3.7 Notification to NCDEQ Shellfish Sanitation Section

Permittees shall notify the NCDEQ Shellfish Sanitation Section prior to dredging in or removing sediment from an area closed to shell fishing where the effluent may be released to an area open for shell fishing or swimming in order to avoid contamination from the disposal area and cause a temporary shellfish closure to be made. Such notification shall also be provided to the appropriate Corps Regulatory Field Office. Any disposal of sand to the ocean beach should occur between November 1 and April 30 when recreational usage is low. Only clean sand

should be used and no dredged sand from closed shell fishing areas may be used. If beach disposal were to occur at times other than stated above or if sand from a closed shell fishing area is to be used, a swimming advisory shall be posted, and a press release shall be issued by the permittee.

3.8 Submerged Aquatic Vegetation

Impacts to Submerged Aquatic Vegetation (SAV) are not authorized by any NWP, except NWP 48, unless EFH Consultation has been completed pursuant to the Magnuson-Stevens Fisheries Conservation and Management Act (Magnuson-Stevens Act). Permittees shall submit a PCN (See NWP General Condition 32) to the District Engineer prior to commencing the activity if the project would affect SAV. The permittee may not begin work until notified by the Corps that the requirements of the Magnuson-Stevens Act have been satisfied and that the activity is authorized.

3.9 Sedimentation and Erosion Control Structures and Measures

All PCNs will identify and describe sedimentation and erosion control structures and measures proposed for placement in waters of the United States. The structures and measures should be depicted on maps, surveys or drawings showing location and impacts to jurisdictional wetlands and streams.

3.10 Restoration of Temporary Impacts to Stream Beds

Upon completion of work that involves temporary stream impacts, streambeds are to be restored to pre-project elevations and widths using natural streambed material such that the impacted stream reach mimics the adjacent upstream and downstream reach. The impacted area shall be backfilled with natural streambed material to a depth of at least 12 inches or to the bottom depth of the impacted area if shallower than 12 inches. An engineered in-stream structure or material can be used to provide protection of a buried structure if it provides benefits to the aquatic environment and can be accomplished by a natural streambed design. A permittee may request a waiver of this condition if it is determined a buried structure needs significant physical protection beyond those provided in this condition. This condition does not apply to NWP 27 – Aquatic Habitat Restoration, Enhancement, and Establishment Activities.

3.11 Restoration of Temporary Impacts to Stream Banks

Upon completion of work involving temporary stream bank impacts, stream banks are to be restored to pre-project grade and contours or beneficial grade and contours if the original bank slope is steep and unstable. Natural durable materials, native seed mixes, and native plants and shrubs are to be utilized in the restoration. Natural designs which use bioengineered and/or geo-engineered methods are to be applied. An engineered structure or material can be used to provide protection of a buried structure if it provides benefits to the stream bank environment, provided it is not in excess of the minimum amount needed for protection and does not exceed an average of one cubic yard per running foot placed along the bank below the plane of the ordinary high water mark. A permittee may request a waiver of this condition if it is determined a buried structure

needs significant physical protection beyond those provided in this condition. This condition does not apply to NWP 27 – Aquatic Habitat Restoration, Enhancement, and Establishment Activities.

3.12 Federal Navigation Channel Setbacks and Corps Easements

3.12.1 Authorized structures and fills located in or adjacent to Federally authorized waterways will be constructed in accordance with the latest setback criteria established by the Wilmington District Engineer. You may review the setback policy at <http://www.saw.usace.army.mil/Missions/Navigation/Setbacks.aspx>. This general permit does not authorize the construction of hardened or permanently fixed structures within the Federally Authorized Channel Setback, unless the activity is approved by the Corps. The permittee shall submit a PCN (see General Condition 32) to the District Engineer prior to the construction of any structures or fills within the Federally Authorized Channel Setback.

3.12.2 The permittee shall obtain a Consent to Cross Government Easement from the Wilmington District’s Land Use Coordinator prior to any crossing of the Corps easement and/or prior to commencing construction of any structures, authorized dredging or other work within the right-of-way of, or in proximity to, a federally designated disposal area. The Land Use Coordinator may be contacted at: CESAW-OP-N, 69 Darlington Avenue, Wilmington, North Carolina 28403-1343, email: SAWWeb-NAV@usace.army.mil

3.13 Northern Long-eared Bat – Endangered Species Act Compliance

The Wilmington District, U.S. Army Corps of Engineers has consulted with the United States Fish and Wildlife Service (USFWS) in regards to the threatened Northern long-eared bat (NLEB) (*Myotis septentrionalis*) and Standard Local Operating Procedures for Endangered Species (SLOPES) have been approved by the Corps and the USFWS. This condition concerns effects to the NLEB only and does not address effects to other federally listed species and/or federally designated critical habitat.

A. Procedures when the Corps is the lead federal* agency for a project:

The permittee must comply with (1) and (2) below when:

- the project is located in the western 41 counties of North Carolina, to include non-federal aid North Carolina Department of Transportation (NCDOT) projects, OR;
- the project is located in the 59 eastern counties of North Carolina, and is a non-NCDOT project.

*Generally, if a project is located on private property or on non-federal land, and the project is not being funded by a federal entity, the Corps will be the lead federal agency due to the requirement to obtain Department of the Army authorization to impact waters of the United States. If the project is located on federal land, contact the Corps to determine the lead federal agency.

(1) A permittee using a NWP must check to see if their project is located in the range of the NLEB by using the following website:

<http://www.fws.gov/midwest/endangered/mammals/nleb/pdf/WNSZone.pdf>. If the project is within the range of the NLEB, or if the project includes percussive activities (e.g., blasting, pile driving, etc.), the permittee is then required to check the appropriate website in the paragraph below to discover if their project:

- is located in a 12-digit Hydrologic Unit Code area (“red HUC” - shown as red areas on the map), AND/OR;
- involves percussive activities within 0.25 mile of a red HUC.

Red HUC maps - for the western 41 counties in NC (covered by the Asheville Ecological Services Field Office), check the project location against the electronic maps found at: http://www.fws.gov/asheville/htmls/project_review/NLEB_in_WNC.html. For the eastern 59 counties in NC (covered by the Raleigh Ecological Services Field Office), check the project location against the electronic maps found at: https://www.fws.gov/raleigh/NLEB_RFO.html.

(2) A permittee must submit a PCN to the District Engineer, and receive written authorization from the District Engineer, prior to commencing the activity, if the activity will involve any of the following:

- tree clearing/removal, construction/installation of wind turbines in a red HUC, AND/OR;
- bridge removal or maintenance, unless the bridge has been inspected and there is no evidence of bat use, (applies anywhere in the range of the NLEB), AND/OR;
- percussive activities in a red HUC, or within 0.25 mile of a red HUC.

The permittee may proceed with the activity without submitting a PCN to either the Corps or the USFWS, provided the activity complies with all applicable NWP terms and general and regional conditions, if the permittee’s review under A.(1) and A.(2) above shows that the project is:

- located outside of a red HUC (and there are no percussive activities), and the activity will NOT include bridge removal or maintenance, unless the bridge has been inspected and there is no evidence of bat use, OR;
- located outside of a red HUC and there are percussive activities, but the percussive activities will not occur within 0.25-mile of a red HUC boundary, and the activity will NOT include bridge removal or maintenance, unless the bridge has been inspected and there is no evidence of bat use, OR;

- located in a red HUC, but the activity will NOT include: tree clearing/removal; construction/installation of wind turbines; bridge removal or maintenance, unless the bridge has been inspected and there is no evidence of bat use, and/or; any percussive activities.

B. Procedures when the USACE is not the lead federal agency:

For projects where another federal agency is the lead federal agency - if that other federal agency has completed project-specific ESA Section 7(a)(2) consultation for the NLEB, and has (1) determined that the project would not cause prohibited incidental take of the NLEB, and (2) completed coordination/consultation that is required by the USFWS (per the directions on the respective USFWS office's website), that project may proceed without notification to either the USACE or the USFWS, provided all General and Regional Permit Conditions are met.

The NLEB SLOPES can be viewed on the USACE website at the following World Wide Web Page: <http://www.saw.usace.army.mil/Missions/Regulatory-Permit-Program/Agency-Coordination/ESA/>. Permittees who do not have internet access may contact the USACE at (910) 251- 4633.

3.14 Work on Eastern Band of Cherokee Indians Land

All PCNs submitted for activities in waters of the United States on Eastern Band of Cherokee Indians (EBCI) trust land (i.e., Qualla Boundary and non-contiguous tracts of trust land), must comply with the requirements of the latest MOU between the Wilmington District and the Eastern Band of Cherokee Indians.

4.0 Additional Regional Conditions for Specific Nationwide Permits

4.1 NWP #14 - Linear Transportation Projects

4.1.1 If appropriate, permittees shall employ natural channel design (see definition below and NOTE below) to the maximum extent practicable for stream relocations. All stream relocation proposals shall include a Relocation and Monitoring Plan and a functional assessment of baseline conditions (e.g., use of the North Carolina Stream Assessment Methodology). Compensatory mitigation may be required for stream relocations.

Natural Channel Design means a geomorphologic approach to stream restoration based on an understanding of valley type, general watershed conditions, dimension, pattern, profile, hydrology and sediment transport of natural, stable channels (reference condition) and applying this understanding to the reconstruction of a stable channel.

NOTE: For more information on Natural Channel Design, permittees should reference North Carolina Stream Mitigation Guidance on the Corps RIBITS (Regulatory In-lieu Fee and Bank Information Tracking System) website or at the following World Wide Web Page:

https://ribits.usace.army.mil/ribits_apex/f?p=107:27:16705499703550::NO:RP:P27_BUTTON_KEY:0.

4.1.2 This NWP authorizes only upland to upland crossings and cannot be used in combination with Nationwide Permit 18 to create an upland within waters of the United States, including wetlands.

4.1.3 This NWP cannot be used for private projects located in tidal waters or tidal wetlands.

4.1.4 In designated trout watersheds, a PCN is not required for impacts to a maximum of 60 linear feet (150 linear feet for temporary dewatering) or 1/10-acre of jurisdictional aquatic resources for proposed structures not adjoining, adjacent to, or connected to existing structures. In designated trout waters, the permittee shall submit a PCN (see Regional Conditions 2.7 and General Condition 32) to the District Engineer prior to commencing the activity if 1) impacts (other than temporary dewatering to work in dry conditions) to jurisdictional aquatic resources exceed 60 linear feet or 1/10-acre; 2) temporary impacts to streams or waterbodies associated with dewatering to work in dry conditions exceed 150 linear feet; 3) the project will involve impacts to wetlands; 4) the primary purpose of the project is for commercial development; 5) the project involves the replacement of a bridge or spanning structure with a culvert or non-spanning structure in waters of the United States; or 6) the activity will be constructed during the trout waters moratorium (October 15 through April 15).

4.1.5 The permittee shall submit a PCN to the District Engineer prior to commencing the activity if the activity will involve the discharge of dredged or fill material into more than 150 linear feet of stream channel for the construction of temporary access fills and/or temporary road crossings. The PCN must include a restoration plan that thoroughly describes how all temporary fills will be removed, describes how pre-project conditions will be restored, and includes a timetable for all restoration activities.



NORTH CAROLINA
Environmental Quality

ROY COOPER
Governor

MICHAEL S. REGAN
Secretary

LINDA CULPEPPER
Interim Director

November 20, 2018
Wayne County
NCDWR Project No. 20181556
US Hwy 117-A
TIP No. U-2714

**APPROVAL of 401 WATER QUALITY CERTIFICATION and NEUSE BUFFER AUTHORIZATION,
with ADDITIONAL CONDITIONS**

Mr. Ronnie Keeter, PE, Division Engineer
NCDOT Division 4
PO Box 3165
Wilson NC 27828

Dear Mr. Keeter:

You have our approval, in accordance with the conditions listed below, for the following impacts for the purpose of upgrading highway US 117-A (North Williams Street) in Wayne County:

Stream Impacts in the Neuse River Basin

Site	Permanent Fill in Perennial Stream (linear ft)	Temporary Dewatering to Perennial Stream (linear ft)	Total Stream Impact (linear ft)
Total	27	71	98

Total Stream Impact for Project: 98 linear feet.

Neuse Riparian Buffer Impacts

Site	Zone 1 Impact (sq ft)	Zone 1 Buffer Mitigation Required (using 3:1 ratio)	Zone 2 Impact (sq ft)	Zone 2 Buffer Mitigation Required (using 1.5:1 ratio)
Totals	2356	N/A	1370	N/A

* n/a = Total for Site is less than 1/3 acre and 150 linear feet of impact, no mitigation required

Total Buffer Impact for Project: 3726 square feet.



The project shall be constructed in accordance with your application received November 15, 2018. After reviewing your application, we have decided that these impacts are covered by General Water Quality Certification Number 4135. This certification corresponds to the Nationwide Permit issued by the Corps of Engineers. This approval is also valid for the Neuse Riparian Buffer Rules (15A NCAC 2B.0233). In addition, you should acquire any other federal, state or local permits before you proceed with your project including (but not limited to) Sediment and Erosion Control, Non-Discharge and Water Supply Watershed regulations. This approval will expire with the accompanying 404 permit.

This approval is valid solely for the purpose and design described in your application (unless modified below). Should your project change, you must notify the NCDWR and submit a new application. If the property is sold, the new owner must be given a copy of this Certification and approval letter, and is thereby responsible for complying with all the conditions. If total wetland fills for this project (now or in the future) exceed one acre, or of total impacts to streams (now or in the future) exceed 150 linear feet, compensatory mitigation may be required as described in 15A NCAC 2H .0506 (h) (6) and (7). Additional buffer impacts may require compensatory mitigation as described in 15A NCAC 2B.0233. For this approval to remain valid, you must adhere to the conditions listed in the General Certification and any additional conditions listed below.

Conditions of Certification:

1. For any streams being impacted due to site dewatering activities, the site shall be graded to its preconstruction contours and revegetated with appropriate native species. [15A NCAC 02H.0506(b)(2)]
2. All stormwater runoff shall be directed as sheetflow through stream buffers at non-erosive velocities, unless otherwise approved by this certification. [15A NCAC 2B.0233]
3. All riparian buffers impacted by the placement of temporary fill or clearing activities shall be restored to the preconstruction contours and revegetated. Maintained buffers shall be permanently revegetated with non-woody species by the end of the growing season following completion of construction. For the purpose of this condition, maintained buffer areas are defined as areas within the transportation corridor that will be subject to regular NCDOT maintenance activities including mowing. The area with non-maintained buffers shall be permanently revegetated with native woody species before the next growing season following completion of construction. [15A NCAC 2B.0233]
4. Pursuant to 15A NCAC 2B.0233(6), sediment and erosion control devices shall not be placed in Zone 1 of any Neuse Buffer without prior approval by the NCDWR. At this time, the NCDWR has approved no sediment and erosion control devices in Zone 1, outside of the approved project impacts, anywhere on this project. Moreover, sediment and erosion control devices shall be allowed in Zone 2 of the buffers provided that Zone 1 is not compromised and that discharge is released as diffuse flow.
5. If concrete is used during construction, a dry work area shall be maintained to prevent direct contact between curing concrete and stream water. Water that inadvertently contacts uncured concrete shall not be discharged to surface waters due to the potential for elevated pH and possible aquatic life and fish kills. [15A NCAC 02B.0200]
6. During the construction of the project, no staging of equipment of any kind is permitted in waters of the U.S., or protected riparian buffers. [15A NCAC 02H.0506(b)(2)]
7. The dimension, pattern and profile of the stream above and below the crossing shall not be modified. Disturbed floodplains and streams shall be restored to natural geomorphic conditions. [15A NCAC 02H.0506(b)(2)]
8. The use of rip-rap above the Normal High Water Mark shall be minimized. Any rip-rap placed for stream stabilization shall be placed in stream channels in such a manner that it does not impede aquatic life passage. [15A NCAC 02H.0506(b)(2)]



- *9. The Permittee shall ensure that the final design drawings adhere to the permit and to the permit drawings submitted for approval. [15A NCAC 02H .0507 (c) and 15A NCAC 02H .0506 (b)(2) and (c)(2)]
- 10. All work in or adjacent to stream waters shall be conducted in a dry work area. Approved BMP measures from the most current version of NCDOT Construction and Maintenance Activities manual such as sandbags, rock berms, cofferdams and other diversion structures shall be used to prevent excavation in flowing water. [15A NCAC 02H.0506(b)(3) and (c)(3)]
- 11. Heavy equipment shall be operated from the banks rather than in the stream channel in order to minimize sedimentation and reduce the introduction of other pollutants into the stream. [15A NCAC 02H.0506(b)(3)]
- 12. All mechanized equipment operated near surface waters must be regularly inspected and maintained to prevent contamination of stream waters from fuels, lubricants, hydraulic fluids, or other toxic materials. [15A NCAC 02H.0506(b)(3)]
- 13. No rock, sand or other materials shall be dredged from the stream channel except where authorized by this certification. [15A NCAC 02H.0506(b)(3)]
- 14. Discharging hydroseed mixtures and washing out hydroseeders and other equipment in or adjacent to surface waters is prohibited. [15A NCAC 02H.0506(b)(3)]
- 15. The permittee and its authorized agents shall conduct its activities in a manner consistent with State water quality standards (including any requirements resulting from compliance with §303(d) of the Clean Water Act) and any other appropriate requirements of State and Federal law. If the NCDWR determines that such standards or laws are not being met (including the failure to sustain a designated or achieved use) or that State or federal law is being violated, or that further conditions are necessary to assure compliance, the NCDWR may reevaluate and modify this certification. [15A NCAC 02B.0200]
- 16. A copy of this Water Quality Certification shall be maintained on the construction site at all times. In addition, the Water Quality Certification and all subsequent modifications, if any, shall be maintained with the Division Engineer and the on-site project manager. [15A NCAC 02H .0507(c) and 15A NCAC 02H .0506 (b)(2) and (c)(2)]
- 17. The outside buffer, wetland or water boundary located within the construction corridor approved by this authorization, including all non-commercial borrow and waste sites associated with the project, shall be clearly marked by highly visible fencing prior to any land disturbing activities. Impacts to areas within the fencing are prohibited unless otherwise authorized by this certification. [15A NCAC 02H.0501 and .0502]
- 18. The issuance of this certification does not exempt the Permittee from complying with any and all statutes, rules, regulations, or ordinances that may be imposed by other government agencies (i.e. local, state, and federal) having jurisdiction, including but not limited to applicable buffer rules, stormwater management rules, soil erosion and sedimentation control requirements, etc.
- 19. The Permittee shall report any violations of this certification to the Division of Water Resources within 24 hours of discovery. [15A NCAC 02B.0506(b)(2)]
- *20. Upon completion of the project (including any impacts at associated borrow or waste sites), the NCDOT Division Engineer (or whomever is the authorized agent if a non-NCDOT project) shall complete and return the enclosed "Certification of Completion Form" to notify the NCDWR when all work included in the 401 Certification has been completed. [15A NCAC 02H.0502(f)]
- 21. Native riparian vegetation (i.e., trees and shrubs native to your geographic region) must be reestablished in the riparian areas within the construction limits of the project by the end of the growing season following completion of construction. [15A NCAC 02B.0233(10)] & [15A NCAC 02B.0506(b)(2)]



22. There shall be no excavation from, or waste disposal into, jurisdictional wetlands or waters associated with this permit without appropriate modification. Should waste or borrow sites, or access roads to waste or borrow sites, be located in wetlands or streams, compensatory mitigation will be required since that is a direct impact from road construction activities. [15A NCAC 02H.0506(b)(3) and (c)(3)]

23. Erosion and sediment control practices must be in full compliance with all specifications governing the proper design, installation and operation and maintenance of such Best Management Practices in order to protect surface waters standards [15A NCAC 02H.0506(b)(3) and (c)(3)]:

- a. The erosion and sediment control measures for the project must be designed, installed, operated, and maintained in accordance with the most recent version of the *North Carolina Sediment and Erosion Control Planning and Design Manual*.
- b. The design, installation, operation, and maintenance of the sediment and erosion control measures must be such that they equal, or exceed, the requirements specified in the most recent version of the *North Carolina Sediment and Erosion Control Manual*. The devices shall be maintained on all construction sites, borrow sites, and waste pile (spoil) projects, including contractor-owned or leased borrow pits associated with the project.
- c. For borrow pit sites, the erosion and sediment control measures must be designed, installed, operated, and maintained in accordance with the most recent version of the *North Carolina Surface Mining Manual*.
- d. The reclamation measures and implementation must comply with the reclamation in accordance with the requirements of the Sedimentation Pollution Control Act.

24. Sediment and erosion control measures shall not be placed in wetlands or surface waters, or within 5 feet of the top of bank, without prior approval from DWR. [15A NCAC 02H.0506(b)(3) and (c)(3)]

25. When applicable, all construction activities shall be performed and maintained in full compliance with G.S. Chapter 113A Article 4 (Sediment and Pollution Control Act of 1973). Regardless of applicability of the Sediment and Pollution Control Act, all projects shall incorporate appropriate Best Management Practices for the control of sediment and erosion so that no violations of state water quality standards, statutes, or rules occur. [15A NCAC 02H.0506(b)(3) and (c)(3) and 15A NCAC 02B.0200]

26. Design, installation, operation, and maintenance of all sediment and erosion control measures shall be equal to or exceed the requirements specified in the most recent version of the *North Carolina Sediment and Erosion Control Manual*, or for linear transportation projects, the *NCDOT Sediment and Erosion Control Manual*.

All devices shall be maintained on all construction sites, borrow sites, and waste pile (spoil) sites, including contractor-owned or leased borrow pits associated with the project. Sufficient materials required for stabilization and/or repair of erosion control measures and stormwater routing and treatment shall be on site at all times.

For borrow pit sites, the erosion and sediment control measures shall be designed, installed, operated, and maintained in accordance with the most recent version of the *North Carolina Surface Mining Manual*. Reclamation measures and implementation shall comply with the reclamation in accordance with the requirements of the Sedimentation Pollution Control Act and the Mining Act of 1971. [15A NCAC 02H.0506(b)(3) and (c)(3); GC 4135]



If you wish to contest any statement in the attached Certification you must file a petition for an administrative hearing. You may obtain the petition form from the office of Administrative hearings. You must file the petition with the office of Administrative Hearings within sixty (60) days of receipt of this notice. A petition is considered filed when it is received in the office of Administrative Hearings during normal office hours. The Office of Administrative Hearings accepts filings Monday through Friday between the hours of 8:00am and 5:00pm, except for official state holidays. The original and one (1) copy of the petition must be filed with the Office of Administrative Hearings.

The petition may be faxed-provided the original and one copy of the document is received by the Office of Administrative Hearings within five (5) business days following the faxed transmission. The mailing address for the Office of Administrative Hearings is:

Office of Administrative Hearings
6714 Mail Service Center
Raleigh, NC 27699-6714
Telephone: (919) 431-3000, Facsimile: (919) 431-3100

A copy of the petition must also be served on DEQ as follows:

Mr. Bill F. Lane, General Counsel
Department of Environmental Quality
1601 Mail Service Center

This letter completes the review of the Division of Water Resources under Section 401 of the Clean Water Act. If you have any questions, please contact Rob Ridings at 919-707-8786.

Sincerely,



for Linda Culpepper, Interim Director
Division of Water Resources

Electronic copy only distribution:

Eric Alsmeyer, US Army Corps of Engineers, Raleigh Field Office
Chad Coggins, Division 4 Environmental Officer
File Copy



STATE OF NORTH CAROLINA
DEPARTMENT OF ENVIRONMENTAL QUALITY
DIVISION OF WATER RESOURCES

WATER QUALITY GENERAL CERTIFICATION NO. 4135

GENERAL CERTIFICATION FOR PROJECTS ELIGIBLE FOR US ARMY CORPS OF ENGINEERS

- **NATIONWIDE PERMIT NUMBER 14 (LINEAR TRANSPORTATION PROJECTS), AND**
- **REGIONAL GENERAL PERMIT 198200031 (NCDOT BRIDGES, WIDENING PROJECTS, INTERCHANGE IMPROVEMENTS)**

Water Quality Certification Number 4135 is issued in conformity with the requirements of Section 401, Public Laws 92-500 and 95-217 of the United States and subject to the North Carolina Regulations in 15A NCAC 02H .0500 and 15A NCAC 02B .0200 for the discharge of fill material to surface waters and wetland areas as described in 33 CFR 330 Appendix A (B) (14) of the US Army Corps of Engineers regulations and Regional General Permit 198200031.

The State of North Carolina certifies that the specified category of activity will not violate applicable portions of Sections 301, 302, 303, 306 and 307 of the Public Laws 92-500 and 95-217 if conducted in accordance with the conditions hereinafter set forth.

Effective date: December 1, 2017

Signed this day: December 1, 2017

By

A handwritten signature in black ink, appearing to read 'Linda Culpepper', is written over a solid horizontal line.

for Linda Culpepper
Interim Director

GC4135

Activities meeting any one (1) of the following thresholds or circumstances require written approval for a 401 Water Quality Certification from the Division of Water Resources (DWR):

- a) If any of the conditions of this Certification (listed below) cannot be met; or
- b) Any temporary or permanent impacts to wetlands, open waters and/or streams, except for construction of a driveway to a single family residential lot that is determined to not be part of a larger common plan of development, as long as the driveway involves a travel lane of less than 25 feet and total stream impacts of less than 60 feet, including any topographic/slope stabilization or in-stream stabilization needed for the crossing; or
- c) Any stream relocation or stream restoration; or
- d) Any high-density project, as defined in 15A NCAC 02H .1003(2)(a) and by the density thresholds specified in 15A NCAC 02H .1017, which:
 - i. Disturbs one acre or more of land (including a project that disturbs less than one acre of land that is part of a larger common plan of development or sale); and
 - ii. Has permanent wetland, stream or open water impacts; and
 - iii. Is proposing new built-upon area; and
 - iv. Does not have a stormwater management plan reviewed and approved under a state stormwater program¹ or a state-approved local government stormwater program².

Projects that have vested rights, exemptions, or grandfathering from state or locally-implemented stormwater programs and projects that satisfy state or locally-implemented stormwater programs through use of community in-lieu programs **require written approval**; or

- e) Any permanent impacts to waters, or to wetlands adjacent to waters, designated as: ORW (including SAV), HQW (including PNA), SA, WS-I, WS-II, or North Carolina or National Wild and Scenic River.
- f) Any permanent impacts to waters, or to wetlands adjacent to waters, designated as Trout except for driveway projects that are below threshold (b) above provided that:
 - i. The impacts are not adjacent to any existing structures
 - ii. All conditions of this General Certification can be met, including adherence to any moratoriums as stated in Condition #10; and
 - iii. A *Notification of Work in Trout Watersheds Form* is submitted to the Division at least 60 days prior to commencement of work; or
- g) Any permanent impacts to coastal wetlands [15A NCAC 07H .0205], or Unique Wetlands (UWL); or
- h) Any impact associated with a Notice of Violation or an enforcement action for violation(s) of NC Wetland Rules (15A NCAC 02H .0500), NC Isolated Wetland Rules (15A NCAC 02H .1300), NC Surface Water or Wetland Standards (15A NCAC 02B .0200), or State Regulated Riparian Buffer Rules (15A NCAC 02B .0200); or

¹ e.g. Coastal Counties, HQW, ORW, or state-implemented Phase II NPDES

² e.g. Delegated Phase II NPDES, Water Supply Watershed, Nutrient-Sensitive Waters, or Universal Stormwater Management Program

GC4135

- * i) Any impacts to subject water bodies and/or state regulated riparian buffers along subject water bodies in the Neuse, Tar-Pamlico, or Catawba River Basins or in the Randleman Lake, Jordan Lake or Goose Creek Watersheds (or any other basin or watershed with State Regulated Riparian Area Protection Rules [Buffer Rules] in effect at the time of application) *unless*:
 - i. The activities are listed as “EXEMPT” from these rules; or
 - ii. A Buffer Authorization Certificate is issued by the NC Division of Coastal Management (DCM); or
 - iii. A Buffer Authorization Certificate or a Minor Variance is issued by a delegated or designated local government implementing a state riparian buffer program pursuant to 143-215.23

Activities included in this General Certification that do not meet one of the thresholds listed above do not require written approval.

I. ACTIVITY SPECIFIC CONDITIONS:

- * 1. If this Water Quality Certification is used to access residential, commercial or industrial building sites, then all parcels owned by the applicant that are part of the single and complete project authorized by this Certification must be buildable without additional impacts to streams or wetlands. If required in writing by DWR, the applicant shall provide evidence that the parcels are buildable without requiring additional impacts to wetlands, waters, or state regulated riparian buffers. [15A NCAC 02H .0506(b)(4) and (c)(4)]
- 2. For road and driveway construction purposes, this Certification shall only be utilized from natural high ground to natural high ground. [15A NCAC 02H .0506(b)(2) and (c)(2)]
- * 3. Deed notifications or similar mechanisms shall be placed on all lots with retained jurisdictional wetlands, waters, and state regulated riparian buffers within the project boundaries in order to assure compliance with NC Wetland Rules (15A NCAC 02H .0500), NC Isolated Wetland Rules (15A NCAC 02H .1300), and/or State Regulated Riparian Buffer Rules (15A NCAC 02B .0200). These mechanisms shall be put in place at the time of recording of the property or individual parcels, whichever is appropriate. [15A NCAC 02H .0506(b)(4) and (c)(4)]
- 4. For the North Carolina Department of Transportation, compliance with the NCDOT’s individual NPDES permit NCS000250 shall serve to satisfy this condition. All other high-density projects that trigger threshold item (d) above shall comply with one of the following requirements: [15A NCAC 02H .0506(b)(5) and (c)(5)]

GC4135

- a. Provide a completed Stormwater Management Plan (SMP) for review and approval, including all appropriate stormwater control measure (SCM) supplemental forms and associated items, that complies with the high-density development requirements of 15A NCAC 02H .1003. Stormwater management shall be provided throughout the entire project area in accordance with 15A NCAC 02H .1003. For the purposes of 15A NCAC 02H .1003(2)(a), density thresholds shall be determined in accordance with 15A NCAC 02H .1017.
- b. Provide documentation (including calculations, photos, etc.) that the project will not cause degradation of downstream surface waters. Documentation shall include a detailed analysis of the hydrological impacts from stormwater runoff when considering the volume and velocity of stormwater runoff from the project built upon area and the size and existing condition of the receiving stream(s).

Exceptions to this condition require application to and written approval from DWR.

II. GENERAL CONDITIONS:

- * 1. When written authorization is required, the plans and specifications for the project are incorporated into the authorization by reference and are an enforceable part of the Certification. Any modifications to the project require notification to DWR and may require an application submittal to DWR with the appropriate fee. [15A NCAC 02H .0501 and .0502]
2. No waste, spoil, solids, or fill of any kind shall occur in wetlands or waters beyond the footprint of the impacts (including temporary impacts) as authorized in the written approval from DWR; or beyond the thresholds established for use of this Certification without written authorization. [15A NCAC 02H .0501 and .0502]

No removal of vegetation or other impacts of any kind shall occur to state regulated riparian buffers beyond the footprint of impacts approved in a Buffer Authorization or Variance or as listed as an exempt activity in the applicable riparian buffer rules. [15A NCAC 02B .0200]

- * 3. In accordance with 15A NCAC 02H .0506(h) and Session Law 2017-10, compensatory mitigation may be required for losses of greater than 300 linear feet of perennial streams and/or greater than one (1) acre of wetlands. Impacts associated with the removal of a dam shall not require mitigation when the removal complies with the requirements of Part 3 of Article 21 in Chapter 143 of the North Carolina General Statutes. Impacts to isolated and other non-404 jurisdictional wetlands shall not be combined with 404 jurisdictional wetlands for the purpose of determining when impact thresholds trigger a mitigation requirement. For linear publicly owned and maintained transportation projects that are not determined to be part of a larger common plan of development by the US Army Corps of Engineers, compensatory mitigation may be required for losses of greater than 300 linear feet per perennial stream.

GC4135

Compensatory stream and/or wetland mitigation shall be proposed and completed in compliance with G.S. 143-214.11. For applicants proposing to conduct mitigation within a project site, a complete mitigation proposal developed in accordance with the most recent guidance issued by the US Army Corps of Engineers Wilmington District shall be submitted for review and approval with the application for impacts.

4. All activities shall be in compliance with any applicable State Regulated Riparian Buffer Rules in Chapter 2 of Title 15A.
5. When applicable, all construction activities shall be performed and maintained in full compliance with G.S. Chapter 113A Article 4 (Sediment and Pollution Control Act of 1973). Regardless of applicability of the Sediment and Pollution Control Act, all projects shall incorporate appropriate Best Management Practices for the control of sediment and erosion so that no violations of state water quality standards, statutes, or rules occur. [15A NCAC 02H .0506(b)(3) and (c)(3) and 15A NCAC 02B .0200]

Design, installation, operation, and maintenance of all sediment and erosion control measures shall be equal to or exceed the requirements specified in the most recent version of the *North Carolina Sediment and Erosion Control Manual*, or for linear transportation projects, the *NCDOT Sediment and Erosion Control Manual*.

All devices shall be maintained on all construction sites, borrow sites, and waste pile (spoil) sites, including contractor-owned or leased borrow pits associated with the project. Sufficient materials required for stabilization and/or repair of erosion control measures and stormwater routing and treatment shall be on site at all times.

For borrow pit sites, the erosion and sediment control measures shall be designed, installed, operated, and maintained in accordance with the most recent version of the *North Carolina Surface Mining Manual*. Reclamation measures and implementation shall comply with the reclamation in accordance with the requirements of the Sedimentation Pollution Control Act and the Mining Act of 1971.

If the project occurs in waters or watersheds classified as Primary Nursery Areas (PNAs), SA, WS-I, WS-II, High Quality Waters (HQW), or Outstanding Resource Waters (ORW), then the sedimentation and erosion control designs shall comply with the requirements set forth in 15A NCAC 04B .0124, *Design Standards in Sensitive Watersheds*.

6. Sediment and erosion control measures shall not be placed in wetlands or waters except within the footprint of temporary or permanent impacts authorized under this Certification. Exceptions to this condition require application to and written approval from DWR. [15A NCAC 02H .0501 and .0502]
7. Erosion control matting that incorporates plastic mesh and/or plastic twine shall not be used along streambanks or within wetlands. Exceptions to this condition require application to and written approval from DWR. [15A NCAC 02B .0201]

GC4135

8. An NPDES Construction Stormwater Permit (NCG010000) is required for construction projects that disturb one (1) or more acres of land. The NCG010000 Permit allows stormwater to be discharged during land disturbing construction activities as stipulated in the conditions of the permit. If the project is covered by this permit, full compliance with permit conditions including the erosion & sedimentation control plan, inspections and maintenance, self-monitoring, record keeping and reporting requirements is required. [15A NCAC 02H .0506(b)(5) and (c)(5)]

The North Carolina Department of Transportation (NCDOT) shall be required to be in full compliance with the conditions related to construction activities within the most recent version of their individual NPDES (NCS000250) stormwater permit. [15A NCAC 02H .0506(b)(5) and (c)(5)]

9. All work in or adjacent to streams shall be conducted so that the flowing stream does not come in contact with the disturbed area. Approved best management practices from the most current version of the *NC Sediment and Erosion Control Manual*, or the *NC DOT Construction and Maintenance Activities Manual*, such as sandbags, rock berms, cofferdams, and other diversion structures shall be used to minimize excavation in flowing water. Exceptions to this condition require application to and written approval from DWR. [15A NCAC 02H .0506(b)(3) and (c)(3)]
10. If activities must occur during periods of high biological activity (e.g. sea turtle nesting, fish spawning, or bird nesting), then biological monitoring may be required at the request of other state or federal agencies and coordinated with these activities. [15A NCAC 02H .0506(b)(2) and 15A NCAC 04B .0125]

All moratoriums on construction activities established by the NC Wildlife Resources Commission (WRC), US Fish and Wildlife Service (USFWS), NC Division of Marine Fisheries (DMF), or National Marine Fisheries Service (NMFS) shall be implemented. Exceptions to this condition require written approval by the resource agency responsible for the given moratorium. A copy of the approval from the resource agency shall be forwarded to DWR.

Work within a designated trout watershed of North Carolina (as identified by the Wilmington District of the US Army Corps of Engineers), or identified state or federal endangered or threatened species habitat, shall be coordinated with the appropriate WRC, USFWS, NMFS, and/or DMF personnel.

11. Culverts shall be designed and installed in such a manner that the original stream profiles are not altered and allow for aquatic life movement during low flows. The dimension, pattern, and profile of the stream above and below a pipe or culvert shall not be modified by widening the stream channel or by reducing the depth of the stream in connection with the construction activity. The width, height, and gradient of a proposed culvert shall be such as to pass the average historical low flow and spring flow without adversely altering flow velocity. [15A NCAC 02H .0506(b)(2) and (c)(2)]

GC4135

Placement of culverts and other structures in streams shall be below the elevation of the streambed by one foot for all culverts with a diameter greater than 48 inches, and 20% of the culvert diameter for culverts having a diameter less than or equal to 48 inches, to allow low flow passage of water and aquatic life.

If multiple pipes or barrels are required, they shall be designed to mimic the existing stream cross section as closely as possible including pipes or barrels at flood plain elevation and/or sills where appropriate. Widening the stream channel shall be avoided.

When topographic constraints indicate culvert slopes of greater than 5%, culvert burial is not required, provided that all alternative options for flattening the slope have been investigated and aquatic life movement/connectivity has been provided when possible (e.g. rock ladders, cross vanes, etc.). Notification, including supporting documentation to include a location map of the culvert, culvert profile drawings, and slope calculations, shall be provided to DWR 60 calendar days prior to the installation of the culvert.

When bedrock is present in culvert locations, culvert burial is not required provided that there is sufficient documentation of the presence of bedrock. Notification, including supporting documentation such as, a location map of the culvert, geotechnical reports, photographs, etc. shall be provided to DWR a minimum of 60 calendar days prior to the installation of the culvert. If bedrock is discovered during construction, then DWR shall be notified by phone or email within 24 hours of discovery.

If other site-specific topographic constraints preclude the ability to bury the culverts as described above and/or it can be demonstrated that burying the culvert would result in destabilization of the channel, then exceptions to this condition require application to and written approval from DWR.

Installation of culverts in wetlands shall ensure continuity of water movement and be designed to adequately accommodate high water or flood conditions. When roadways, causeways, or other fill projects are constructed across FEMA-designated floodways or wetlands, openings such as culverts or bridges shall be provided to maintain the natural hydrology of the system as well as prevent constriction of the floodway that may result in destabilization of streams or wetlands.

The establishment of native woody vegetation and other soft stream bank stabilization techniques shall be used where practicable instead of rip-rap or other bank hardening methods.

12. Bridge deck drains shall not discharge directly into the stream. Stormwater shall be directed across the bridge and pre-treated through site-appropriate means to the maximum extent practicable (e.g. grassed swales, pre-formed scour holes, vegetated buffers, etc.) before entering the stream. Exceptions to this condition require application to and written approval from DWR. [15A NCAC 02H .0506(b)(5)]

GC4135

13. Application of fertilizer to establish planted/seeded vegetation within disturbed riparian areas and/or wetlands shall be conducted at agronomic rates and shall comply with all other Federal, State and Local regulations. Fertilizer application shall be accomplished in a manner that minimizes the risk of contact between the fertilizer and surface waters. [15A NCAC 02B .0200 and 15A NCAC 02B .0231]
14. If concrete is used during construction, then all necessary measures shall be taken to prevent direct contact between uncured or curing concrete and waters of the state. Water that inadvertently contacts uncured concrete shall not be discharged to waters of the state. [15A NCAC 02B .0200]
15. All proposed and approved temporary fill and culverts shall be removed and the impacted area shall be returned to natural conditions within 60 calendar days after the temporary impact is no longer necessary. The impacted areas shall be restored to original grade, including each stream's original cross sectional dimensions, planform pattern, and longitudinal bed profile. For projects that receive written approval, no temporary impacts are allowed beyond those included in the application and authorization. All temporarily impacted sites shall be restored and stabilized with native vegetation. [15A NCAC 02H .0506(b)(2) and (c)(2)]
16. All proposed and approved temporary pipes/culverts/rip-rap pads etc. in streams shall be installed as outlined in the most recent edition of the *North Carolina Sediment and Erosion Control Planning and Design Manual* or the *North Carolina Surface Mining Manual* or the *North Carolina Department of Transportation Best Management Practices for Construction and Maintenance Activities* so as not to restrict stream flow or cause dis-equilibrium during use of this Certification. [15A NCAC 02H .0506(b)(2) and (c)(2)]
17. Any rip-rap required for proper culvert placement, stream stabilization, or restoration of temporarily disturbed areas shall be restricted to the area directly impacted by the approved construction activity. All rip-rap shall be placed such that the original stream elevation and streambank contours are restored and maintained. Placement of rip-rap or other approved materials shall not result in de-stabilization of the stream bed or banks upstream or downstream of the area or in a manner that precludes aquatic life passage. [15A NCAC 02H .0506(b)(2)]
18. Any rip-rap used for stream or shoreline stabilization shall be of a size and density to prevent movement by wave, current action, or stream flows and shall consist of clean rock or masonry material free of debris or toxic pollutants. Rip-rap shall not be installed in the streambed except in specific areas required for velocity control and to ensure structural integrity of bank stabilization measures. [15A NCAC 02H .0506(b)(2)]
19. Applications for rip-rap groins proposed in accordance with 15A NCAC 07H .1401 (NC Division of Coastal Management General Permit for construction of Wooden and Rip-rap Groins in Estuarine and Public Trust Waters) shall meet all the specific conditions for design and construction specified in 15A NCAC 07H .1405.

GC4135

20. All mechanized equipment operated near surface waters shall be inspected and maintained regularly to prevent contamination of surface waters from fuels, lubricants, hydraulic fluids, or other toxic materials. Construction shall be staged in order to minimize the exposure of equipment to surface waters to the maximum extent practicable. Fueling, lubrication and general equipment maintenance shall be performed in a manner to prevent, to the maximum extent practicable, contamination of surface waters by fuels and oils. [15A NCAC 02H .0506(b)(3) and (c)(3) and 15A NCAC 02B .0211 (12)]
21. Heavy equipment working in wetlands shall be placed on mats or other measures shall be taken to minimize soil disturbance. [15A NCAC 02H .0506(b)(3) and (c)(3)]
22. In accordance with 143-215.85(b), the applicant shall report any petroleum spill of 25 gallons or more; any spill regardless of amount that causes a sheen on surface waters; any petroleum spill regardless of amount occurring within 100 feet of surface waters; and any petroleum spill less than 25 gallons that cannot be cleaned up within 24 hours.
- * 23. If an environmental document is required under the State Environmental Policy Act (SEPA), then this General Certification is not valid until a Finding of No Significant Impact (FONSI) or Record of Decision (ROD) is issued by the State Clearinghouse. If an environmental document is required under the National Environmental Policy Act (NEPA), then this General Certification is not valid until a Categorical Exclusion, the Final Environmental Assessment, or Final Environmental Impact Statement is published by the lead agency. [15A NCAC 01C .0107(a)]
24. This General Certification does not relieve the applicant of the responsibility to obtain all other required Federal, State, or Local approvals before proceeding with the project, including those required by, but not limited to, Sediment and Erosion Control, Non-Discharge, Water Supply Watershed, and Trout Buffer regulations.
25. The applicant and their authorized agents shall conduct all activities in a manner consistent with State water quality standards (including any requirements resulting from compliance with §303(d) of the Clean Water Act), and any other appropriate requirements of State and Federal Law. If DWR determines that such standards or laws are not being met, including failure to sustain a designated or achieved use, or that State or Federal law is being violated, or that further conditions are necessary to assure compliance, then DWR may revoke or modify a written authorization associated with this General Water Quality Certification. [15A NCAC 02H .0507(d)]
26. The permittee shall require its contractors and/or agents to comply with the terms and conditions of this permit in the construction and maintenance of this project, and shall provide each of its contractors and/or agents associated with the construction or maintenance of this project with a copy of this Certification. A copy of this Certification, including all conditions shall be available at the project site during the construction and maintenance of this project. [15A NCAC 02H .0507 (c) and 15A NCAC 02H .0506 (b)(2) and (c)(2)]

GC4135

- * 27. When written authorization is required for use of this Certification, upon completion of all permitted impacts included within the approval and any subsequent modifications, the applicant shall be required to return a certificate of completion (available on the DWR website <https://edocs.deq.nc.gov/Forms/Certificate-of-Completion>). [15A NCAC 02H .0502(f)]
- 28. Additional site-specific conditions, including monitoring and/or modeling requirements, may be added to the written approval letter for projects proposed under this Water Quality Certification in order to ensure compliance with all applicable water quality and effluent standards. [15A NCAC 02H .0507(c)]
- 29. If the property or project is sold or transferred, the new permittee shall be given a copy of this Certification (and written authorization if applicable) and is responsible for complying with all conditions. [15A NCAC 02H .0501 and .0502]

III. GENERAL CERTIFICATION ADMINISTRATION:

- * 1. In accordance with North Carolina General Statute 143-215.3D(e), written approval for a 401 Water Quality General Certification must include the appropriate fee. An applicant for a CAMA permit under Article 7 of Chapter 113A of the General Statutes for which a Water Quality Certification is required shall only make one payment to satisfy both agencies; the fee shall be as established by the Secretary in accordance with 143-215.3D(e)(7).
- 2. This Certification neither grants nor affirms any property right, license, or privilege in any waters, or any right of use in any waters. This Certification does not authorize any person to interfere with the riparian rights, littoral rights, or water use rights of any other person and this Certification does not create any prescriptive right or any right of priority regarding any usage of water. This Certification shall not be interposed as a defense in any action respecting the determination of riparian or littoral rights or other rights to water use. No consumptive user is deemed by virtue of this Certification to possess any prescriptive or other right of priority with respect to any other consumptive user regardless of the quantity of the withdrawal or the date on which the withdrawal was initiated or expanded.
- 3. This Certification grants permission to the Director, an authorized representative of the Director, or DWR staff, upon the presentation of proper credentials, to enter the property during normal business hours. [15A NCAC 02H .0502(e)]
- 4. This General Certification shall expire on the same day as the expiration date of the corresponding Nationwide Permit and/or Regional General Permit. The conditions in effect on the date of issuance of Certification for a specific project shall remain in effect for the life of the project, regardless of the expiration date of this Certification. This General Certification is rescinded when the US Army Corps of Engineers reauthorizes any of the corresponding Nationwide Permits and/or Regional General Permits or when deemed appropriate by the Director of the Division of Water Resources.

GC4135

5. Non-compliance with or violation of the conditions herein set forth by a specific project may result in revocation of this General Certification for the project and may also result in criminal and/or civil penalties.
- * 6. The Director of the North Carolina Division of Water Resources may require submission of a formal application for Individual Certification for any project in this category of activity if it is deemed in the public's best interest or determined that the project is likely to have a significant adverse effect upon water quality, including state or federally listed endangered or threatened aquatic species, or degrade the waters so that existing uses of the water or downstream waters are precluded.

History Note: Water Quality Certification (WQC) Number 4135 issued December 1, 2017 replaces WQC Number 4088 issued March 3, 2017; WQC 3886 issued March 12, 2012; WQC Number 3820 issued April 6, 2010; WQC Number 3627 issued March 2007; WQC Number 3404 issued March 2003; WQC Number 3375 issued March 18, 2002; WQC Number 3289 issued June 1, 2000; WQC Number 3103 issued February 11, 1997; WQC Number 2732 issued May 1, 1992; WQC Number 2666 issued January 21, 1992; WQC Number 2177 issued November 5, 1987.

PROJECT REFERENCE NO.	U-2714	SHEET NO.	9
ROADWAY DESIGN ENGINEER	HYDRAULICS ENGINEER		
INCOMPLETE PLANS DO NOT USE FOR CONSTRUCTION			
FOR SIGNATURES ONLY UNLESS ALL SIGNATURES COMPLETED			
HR HRP Engineering, Inc. of the Carolinas 1500 S. Salisbury Blvd., Suite 200 N.C.B.E.L.S. License Number F40116			

NOT TO SCALE



LEGEND



DENOTES IMPACTS IN SURFACE WATER



DENOTES TEMPORARY IMPACTS IN SURFACE WATER

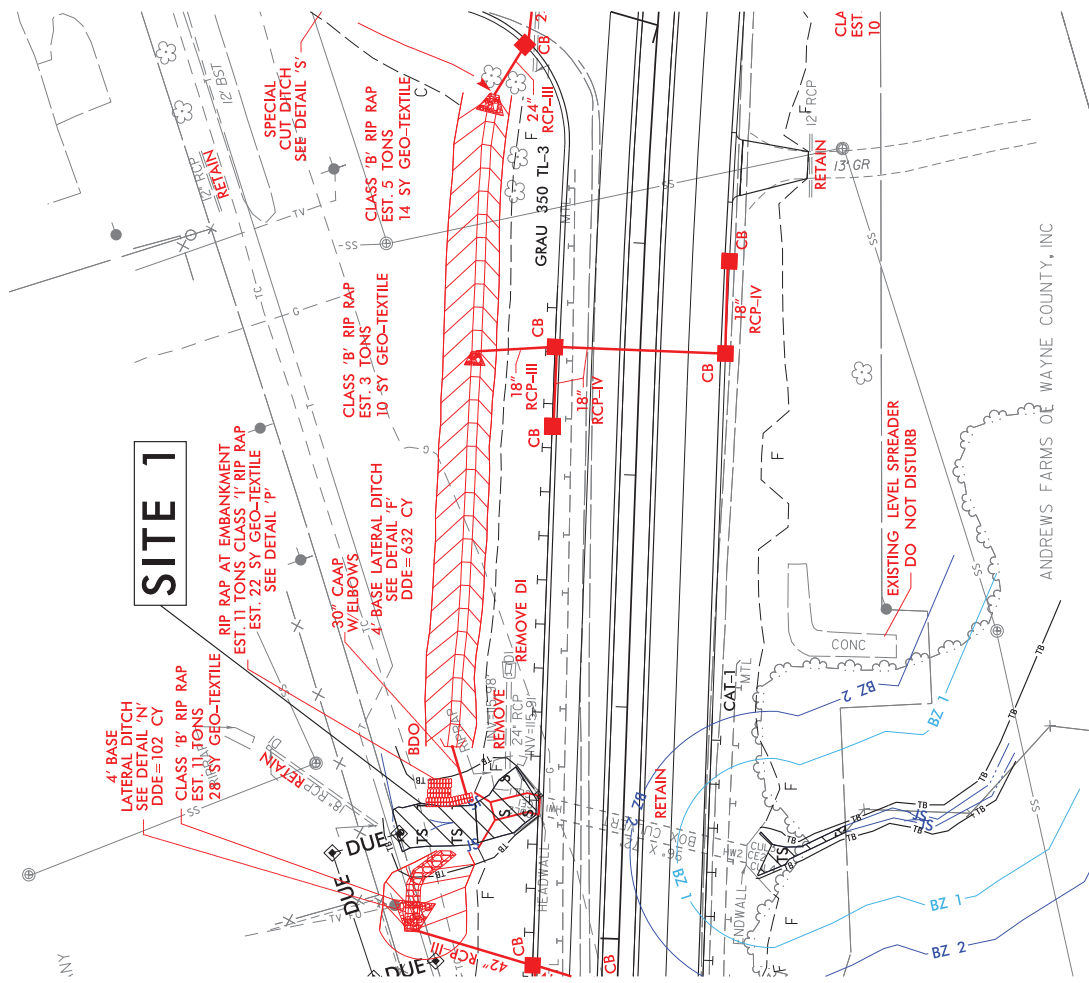

PERMIT DRAWING
SHEET 5 OF 7

PROJECT REFERENCE NO. U-2714	SHEET NO. 1
DESIGNED BY R. W. BAKER	CHECKED BY R. W. BAKER
DRAWN BY R. W. BAKER	
DOCUMENT NOT CONSIDERED FINAL UNLESS ALL SIGNATURES COMPLETED	

HDR
HDR Engineering, Inc. of the Carolinas
355 Parkway S. Suite 200, Raleigh, N.C. 27601
N.C.B.E.L.S. License Number: F-2116

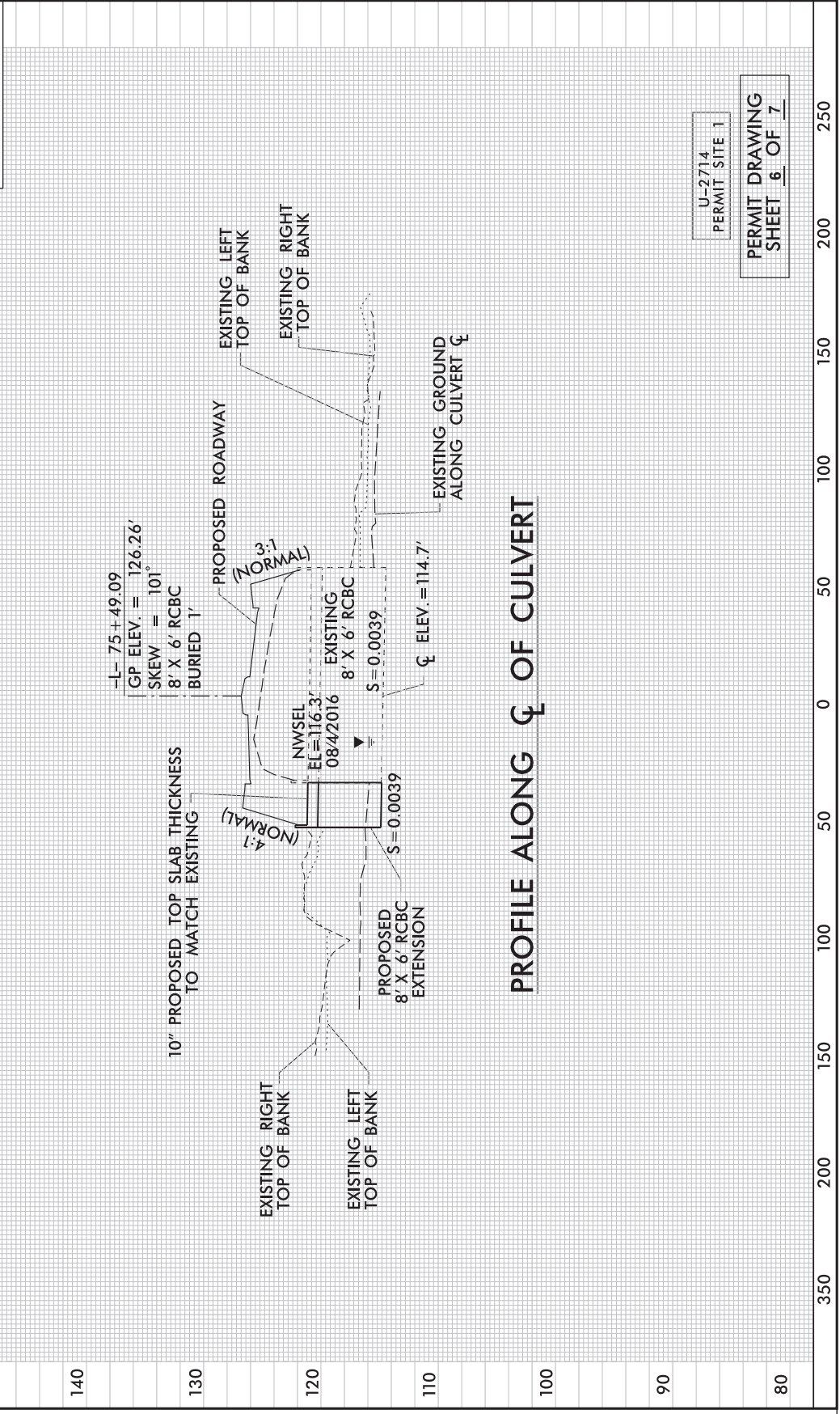
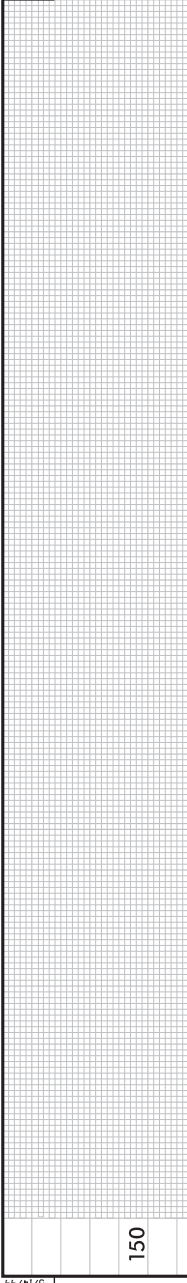

PROFILE ALONG ζ OF CULVERT

U-2714
PERMIT SITE 1
PERMIT DRAWING
SHEET 6 OF 7

5/14/99

STATE OF NORTH CAROLINA
 DIVISION OF HIGHWAYS
WAYNE COUNTY
 LOCATION: US 117A (N. WILLIAMS ST) FROM NORTH OF US 70
 TO SR 1571 (TOMMY'S RD)
 TYPE OF WORK: GRADING, PAVING, DRAINAGE, CULVERT
 AND SIGNALS

STATE	N.C.
FEDERAL PROJECT NUMBER OR STATE PROJECT NUMBER OR	U-2714
PROJECT NUMBER	38797.12
DESCRIPTION	FE
DATE	
BY	
CHECKED	
DATE	

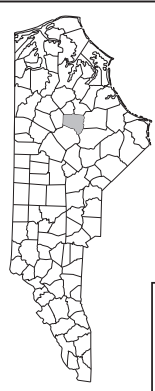

BUFFER IMPACTS PERMIT

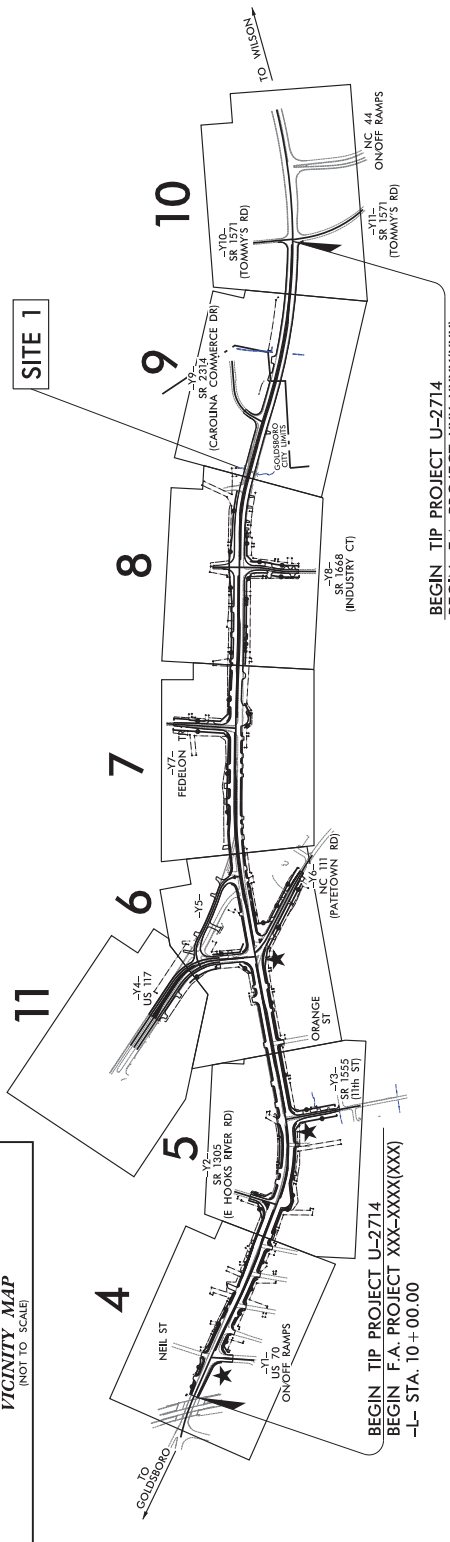
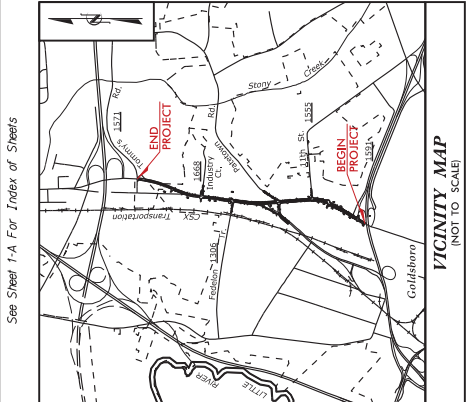

BUFFER DRAWING SHEET 1 OF 5

Prepared by the Office of:
FDR
 HDR Engineering, Inc. of the Carolinas
 555 Fayetteville St., Suite 900 Raleigh, NC 27601
 N.C. BELLS License Number: F-0116

Prepared for the Office of:
DIVISION OF HIGHWAYS
 1000 Birch Ridge Dr., Raleigh, NC, 27610
 THE STANDARD SPECIFICATIONS

RIGHT OF WAY DATE: **CALVIN W. MOODY III, P.E.**
 PROJECT ENGINEER
 FEBRUARY 17, 2017
 LETTING DATE: **CASEY E. HARRIS, P.E.**
 PROJECT DESIGN ENGINEER
 FEBRUARY 20, 2018

HYDRAULICS ENGINEER
 ROADWAY DESIGN ENGINEER
 SIGNATURE: _____ P.E.
 SIGNATURE: _____ P.E.



CLEARING ON THIS PROJECT SHALL BE PERFORMED TO THE LIMITS ESTABLISHED BY METHOD A PORTION OF THIS PROJECT IS WITHIN THE MUNICIPAL BOUNDARIES OF THE CITY OF GOLDSBORO

PROJECT LENGTH
 LENGTH ROADWAY TIP PROJECT U-2714 = 1.546 MILES
 TOTAL LENGTH TIP PROJECT U-2714 = 1.546 MILES

DESIGN DATA

ADT 2018	= 17,390
ADT 2038	= 27,310
DHV	= 9 %
D	= 60 %
T	= 4 %
V	= 40 MPH
(* TTST = 1% + DUAL 3%)	
FUNC. CLASS = MINOR ARTERIAL (URBAN) STATEWIDE TIER	

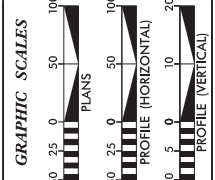

TIP PROJECT: U-2714

CONTRACT:

PLOT1: D:\REVIEWS\NC007\pdr\nc007.pdr\nc007.plt
 USER: wjohnst
 DATE: 8/11/2017
 TIME: 4:27:05 PM
 FILE: NorThCarolinaDeptOfTransportation\NC007\workspace\div\on\col\m\nc007\2714\05117.c\60.cad\B\M\62\work\1\p\09\688\U-2714\NC007.plt

PROJECT REFERENCE NO.	SHEET NO.
U-2714	8
R/W SHEET NO.	R/W-8
ROADWAY DESIGN ENGINEER	HYDRAULICS ENGINEER
INCOMPLETE PLANS DO NOT USE FOR CONSTRUCTION	
DOCUMENT NOT CONSIDERED FINAL UNLESS ALL SIGNATURES COMPLETED	
HDR HDR Engineering, Inc. of the Carolinas 555 Fayetteville Rd., Suite 300, Raleigh, NC 27601 N.C.B.E.L.L.C. License Number: F-0116	

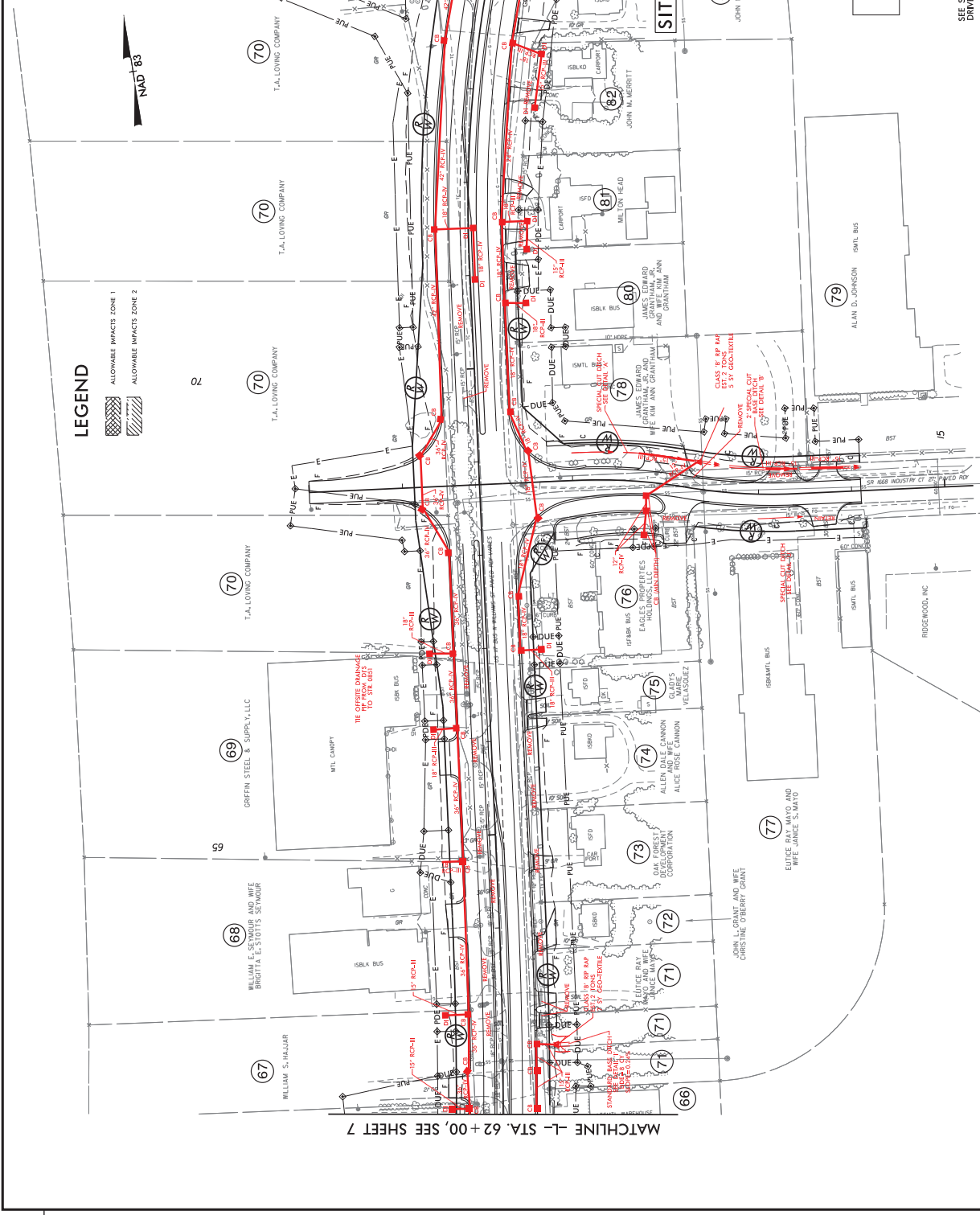

BUFFER DRAWING
SHEET 2 OF 5

★ PROPOSED SIGNAL
 SEE SHEET 1 FOR PROFILE
 SEE SHEET 20 FOR -DRT- PROFILE
 SEE SHEET 20 FOR -DRT- PROFILE
 SEE SHEET 20 FOR PROPOSED DRIVEWAY
 SEE SHEET 20 FOR PROPOSED DRIVEWAY
 DRIVEWAY RADIUS UNLESS OTHERWISE NOTED

PROJECT REFERENCE NO. U-274	SHEET NO. 9
ROADWAY DESIGN ENGINEER	HYDRAULICS ENGINEER
INCOMPLETE PLANS DO NOT USE FOR CONSTRUCTION	
WORKING NOT COMPLETED UNLESS ALL SIGNATURES COMPLETED	
HR HR Engineering, Inc. of the Carolinas 1500 S. Salisbury Road, Suite 100 N.C.B.E.L.S. License Number F-0116	

NOT TO SCALE



LEGEND



ALLOWABLE IMPACTS ZONE 1



ALLOWABLE IMPACTS ZONE 2

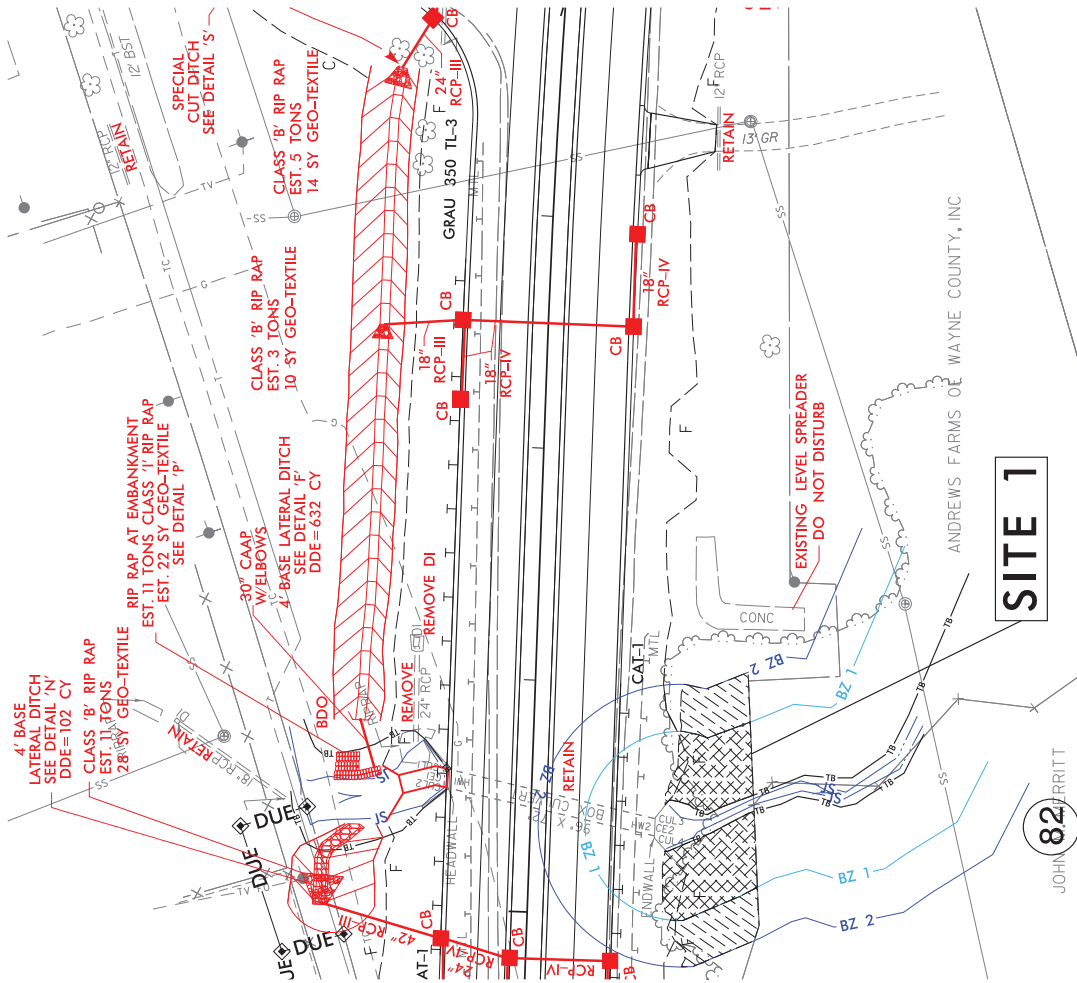

SITE 1

JOHN 82 RYRITT

County : Wayne

Line #	Item Number	Sec #	Description	Quantity	Unit Cost	Amount
ROADWAY ITEMS						
0001	0000100000-N	800	MOBILIZATION	Lump Sum	L.S.	
0002	0000400000-N	801	CONSTRUCTION SURVEYING	Lump Sum	L.S.	
0003	0000915000-N	SP	GENERIC MISCELLANEOUS ITEM REMOVE WOOD POLE	127 EA		
0004	0001000000-E	200	CLEARING & GRUBBING .. ACRE(S)	Lump Sum	L.S.	
0005	0008000000-E	200	SUPPLEMENTARY CLEARING & GRUB- BING	1 ACR		
0006	0022000000-E	225	UNCLASSIFIED EXCAVATION	5,000 CY		
0007	0036000000-E	225	UNDERCUT EXCAVATION	1,000 CY		
0008	0106000000-E	230	BORROW EXCAVATION	42,000 CY		
0009	0134000000-E	240	DRAINAGE DITCH EXCAVATION	1,240 CY		
0010	0156000000-E	250	REMOVAL OF EXISTING ASPHALT PAVEMENT	21,010 SY		
0011	0163000000-E	250	REMOVAL OF EXISTING CONCRETE PAVEMENT	1,000 SY		
0012	0177000000-E	250	BREAKING OF EXISTING ASPHALT PAVEMENT	720 SY		
0013	0195000000-E	265	SELECT GRANULAR MATERIAL	1,000 CY		
0014	0196000000-E	270	GEOTEXTILE FOR SOIL STABILIZA- TION	1,700 SY		
0015	0199000000-E	SP	TEMPORARY SHORING	410 SF		
0016	0255000000-E	SP	GENERIC GRADING ITEM HAULING AND DISPOSAL OF PETROLEUM CONTAMINATED SOIL	300 TON		
0017	0318000000-E	300	FOUNDATION CONDITIONING MATE- RIAL, MINOR STRUCTURES	2,200 TON		
0018	0320000000-E	300	FOUNDATION CONDITIONING GEO- TEXTILE	6,400 SY		

County : Wayne

Line #	Item Number	Sec #	Description	Quantity	Unit Cost	Amount
0019	0335500000-E	305	30" DRAINAGE PIPE	24	LF	
0020	0335850000-E	305	*** DRAINAGE PIPE ELBOWS (30")	2	EA	
0021	0366000000-E	310	15" RC PIPE CULVERTS, CLASS III	692	LF	
0022	0372000000-E	310	18" RC PIPE CULVERTS, CLASS III	1,128	LF	
0023	0378000000-E	310	24" RC PIPE CULVERTS, CLASS III	300	LF	
0024	0384000000-E	310	30" RC PIPE CULVERTS, CLASS III	412	LF	
0025	0390000000-E	310	36" RC PIPE CULVERTS, CLASS III	232	LF	
0026	0396000000-E	310	42" RC PIPE CULVERTS, CLASS III	56	LF	
0027	0448000000-E	310	***** RC PIPE CULVERTS, CLASS IV (12")	108	LF	
0028	0448200000-E	310	15" RC PIPE CULVERTS, CLASS IV	324	LF	
0029	0448300000-E	310	18" RC PIPE CULVERTS, CLASS IV	7,300	LF	
0030	0448400000-E	310	24" RC PIPE CULVERTS, CLASS IV	640	LF	
0031	0448500000-E	310	30" RC PIPE CULVERTS, CLASS IV	268	LF	
0032	0448600000-E	310	36" RC PIPE CULVERTS, CLASS IV	1,168	LF	
0033	0448700000-E	310	42" RC PIPE CULVERTS, CLASS IV	548	LF	
0034	0995000000-E	340	PIPE REMOVAL	4,392	LF	
0035	0996000000-N	350	PIPE CLEAN OUT	1	EA	
0036	1011000000-N	500	FINE GRADING	Lump Sum	L.S.	

County : Wayne

Line #	Item Number	Sec #	Description	Quantity	Unit Cost	Amount
0037	1099500000-E	505	SHALLOW UNDERCUT	500 CY		
0038	1099700000-E	505	CLASS IV SUBGRADE STABILIZATION	1,000 TON		
0039	1121000000-E	520	AGGREGATE BASE COURSE	2,633 TON		
0040	1220000000-E	545	INCIDENTAL STONE BASE	800 TON		
0041	1297000000-E	607	MILLING ASPHALT PAVEMENT, **** DEPTH (1-1/2")	5,350 SY		
0042	1330000000-E	607	INCIDENTAL MILLING	2,060 SY		
0043	1491000000-E	610	ASPHALT CONC BASE COURSE, TYPE B25.0C	19,850 TON		
0044	1503000000-E	610	ASPHALT CONC INTERMEDIATE COURSE, TYPE I19.0C	16,960 TON		
0045	1519000000-E	610	ASPHALT CONC SURFACE COURSE, TYPE S9.5B	14,430 TON		
0046	1575000000-E	620	ASPHALT BINDER FOR PLANT MIX	2,675 TON		
0047	1693000000-E	654	ASPHALT PLANT MIX, PAVEMENT REPAIR	1,840 TON		
0048	1704000000-E	SP	PATCHING EXISTING PAVEMENT	335 TON		
0049	2022000000-E	815	SUBDRAIN EXCAVATION	896 CY		
0050	2033000000-E	815	SUBDRAIN FINE AGGREGATE	672 CY		
0051	2044000000-E	815	6" PERFORATED SUBDRAIN PIPE	4,000 LF		
0052	2070000000-N	815	SUBDRAIN PIPE OUTLET	8 EA		
0053	2077000000-E	815	6" OUTLET PIPE	48 LF		
0054	2209000000-E	838	ENDWALLS	3.4 CY		
0055	2264000000-E	840	PIPE PLUGS	3.1 CY		

County : Wayne

Line #	Item Number	Sec #	Description	Quantity	Unit Cost	Amount
0056	2275000000-E	SP	FLOWABLE FILL	11 CY		
0057	2286000000-N	840	MASONRY DRAINAGE STRUCTURES	182 EA		
0058	2308000000-E	840	MASONRY DRAINAGE STRUCTURES	63.4 LF		
0059	2364000000-N	840	FRAME WITH TWO GRATES, STD 840.16	36 EA		
0060	2366000000-N	840	FRAME WITH TWO GRATES, STD 840.24	1 EA		
0061	2374000000-N	840	FRAME WITH GRATE & HOOD, STD 840.03, TYPE ** (E)	27 EA		
0062	2374000000-N	840	FRAME WITH GRATE & HOOD, STD 840.03, TYPE ** (F)	51 EA		
0063	2374000000-N	840	FRAME WITH GRATE & HOOD, STD 840.03, TYPE ** (G)	55 EA		
0064	2396000000-N	840	FRAME WITH COVER, STD 840.54	11 EA		
0065	2440000000-N	852	CONCRETE TRANSITIONAL SECTION FOR CATCH BASIN	13 EA		
0066	2451000000-N	852	CONCRETE TRANSITIONAL SECTION FOR DROP INLET	13 EA		
0067	2535000000-E	846	***X *** CONCRETE CURB (8" X 18")	240 LF		
0068	2538000000-E	846	***_*** CONCRETE CURB & GUTTER (2'-9")	5,470 LF		
0069	2549000000-E	846	2'-6" CONCRETE CURB & GUTTER	16,910 LF		
0070	2591000000-E	848	4" CONCRETE SIDEWALK	4,220 SY		
0071	2605000000-N	848	CONCRETE CURB RAMPS	120 EA		
0072	2612000000-E	848	6" CONCRETE DRIVEWAY	840 SY		
0073	2619000000-E	850	4" CONCRETE PAVED DITCH	31 SY		

County : Wayne

Line #	Item Number	Sec #	Description	Quantity	Unit Cost	Amount
0074	2655000000-E	852	5" MONOLITHIC CONCRETE ISLANDS (KEYED IN)	2,750 SY		
0075	2815000000-N	858	ADJUSTMENT OF DROP INLETS	1 EA		
0076	2830000000-N	858	ADJUSTMENT OF MANHOLES	1 EA		
0077	3030000000-E	862	STEEL BEAM GUARDRAIL	475 LF		
0078	3150000000-N	862	ADDITIONAL GUARDRAIL POSTS	5 EA		
0079	3210000000-N	862	GUARDRAIL END UNITS, TYPE CAT-1	2 EA		
0080	3287000000-N	SP	GUARDRAIL END UNITS, TYPE TL-3	2 EA		
0081	3360000000-E	863	REMOVE EXISTING GUARDRAIL	630 LF		
0082	3628000000-E	876	RIP RAP, CLASS I	45 TON		
0083	3649000000-E	876	RIP RAP, CLASS B	75 TON		
0084	3656000000-E	876	GEOTEXTILE FOR DRAINAGE	975 SY		
0085	4025000000-E	901	CONTRACTOR FURNISHED, TYPE *** SIGN (A)	38 SF		
0086	4025000000-E	901	CONTRACTOR FURNISHED, TYPE *** SIGN (B)	30 SF		
0087	4025000000-E	901	CONTRACTOR FURNISHED, TYPE *** SIGN (D)	143 SF		
0088	4025000000-E	901	CONTRACTOR FURNISHED, TYPE *** SIGN (E)	755 SF		
0089	4025000000-E	901	CONTRACTOR FURNISHED, TYPE *** SIGN (F)	384 SF		
0090	4054000000-E	902	PLAIN CONCRETE SIGN FOUNDA- TIONS	1 CY		

County : Wayne

Line #	Item Number	Sec #	Description	Quantity	Unit Cost	Amount
0091	4060000000-E	903	SUPPORTS, BREAKAWAY STEEL BEAM	225	LB	
0092	4072000000-E	903	SUPPORTS, 3-LB STEEL U-CHANNEL	2,700	LF	
0093	4096000000-N	904	SIGN ERECTION, TYPE D	10	EA	
0094	4102000000-N	904	SIGN ERECTION, TYPE E	121	EA	
0095	4108000000-N	904	SIGN ERECTION, TYPE F	27	EA	
0096	4110000000-N	904	SIGN ERECTION, TYPE *** (GROUND MOUNTED) (A)	1	EA	
0097	4110000000-N	904	SIGN ERECTION, TYPE *** (GROUND MOUNTED) (B)	1	EA	
0098	4152000000-N	907	DISPOSAL OF SIGN SYSTEM, STEEL BEAM	1	EA	
0099	4158000000-N	907	DISPOSAL OF SIGN SYSTEM, WOOD	100	EA	
0100	4400000000-E	1110	WORK ZONE SIGNS (STATIONARY)	691	SF	
0101	4405000000-E	1110	WORK ZONE SIGNS (PORTABLE)	197	SF	
0102	4410000000-E	1110	WORK ZONE SIGNS (BARRICADE MOUNTED)	184	SF	
0103	4415000000-N	1115	FLASHING ARROW BOARD	3	EA	
0104	4420000000-N	1120	PORTABLE CHANGEABLE MESSAGE SIGN	4	EA	
0105	4430000000-N	1130	DRUMS	651	EA	
0106	4445000000-E	1145	BARRICADES (TYPE III)	128	LF	
0107	4447000000-E	SP	PEDESTRIAN CHANNELIZING DE- VICES	60	LF	
0108	4455000000-N	1150	FLAGGER	20	DAY	
0109	4480000000-N	1165	TMA	4	EA	

County : Wayne

Line #	Item Number	Sec #	Description	Quantity	Unit Cost	Amount
0110	4507000000-E	1170	WATER FILLED BARRIER	500 LF		
0111	4510000000-N	1190	LAW ENFORCEMENT	104 HR		
0112	4650000000-N	1251	TEMPORARY RAISED PAVEMENT MARKERS	619 EA		
0113	4685000000-E	1205	THERMOPLASTIC PAVEMENT MARKING LINES (4", 90 MILS)	32,582 LF		
0114	4688000000-E	1205	THERMOPLASTIC PAVEMENT MARKING LINES (6", 90 MILS)	201 LF		
0115	4695000000-E	1205	THERMOPLASTIC PAVEMENT MARKING LINES (8", 90 MILS)	3,713 LF		
0116	4700000000-E	1205	THERMOPLASTIC PAVEMENT MARKING LINES (12", 90 MILS)	39 LF		
0117	4720000000-E	1205	THERMOPLASTIC PAVEMENT MARKING CHARACTER (90 MILS)	10 EA		
0118	4725000000-E	1205	THERMOPLASTIC PAVEMENT MARKING SYMBOL (90 MILS)	122 EA		
0119	4810000000-E	1205	PAINT PAVEMENT MARKING LINES (4")	134,080 LF		
0120	4820000000-E	1205	PAINT PAVEMENT MARKING LINES (8")	3,358 LF		
0121	4825000000-E	1205	PAINT PAVEMENT MARKING LINES (12")	1,462 LF		
0122	4835000000-E	1205	PAINT PAVEMENT MARKING LINES (24")	1,808 LF		
0123	4840000000-N	1205	PAINT PAVEMENT MARKING CHARACTER	40 EA		
0124	4845000000-N	1205	PAINT PAVEMENT MARKING SYMBOL	232 EA		
0125	4850000000-E	1205	REMOVAL OF PAVEMENT MARKING LINES (4")	35,322 LF		
0126	4860000000-E	1205	REMOVAL OF PAVEMENT MARKING LINES (8")	410 LF		

County : Wayne

Line #	Item Number	Sec #	Description	Quantity	Unit Cost	Amount
0127	4865000000-E	1205	REMOVAL OF PAVEMENT MARKING LINES (12")	367	LF	
0128	4870000000-E	1205	REMOVAL OF PAVEMENT MARKING LINES (24")	555	LF	
0129	4875000000-N	1205	REMOVAL OF PAVEMENT MARKING SYMBOLS & CHARACTERS	66	EA	
0130	4891000000-E	1205	GENERIC PAVEMENT MARKING ITEM THERMOPLASTIC PAVEMENT MARKING LINES (16", 90 MILS)	45	LF	
0131	4891000000-E	1205	GENERIC PAVEMENT MARKING ITEM THERMOPLASTIC PAVEMENT MARKING LINES (24", 90 MILS)	706	LF	
0132	4895000000-N	SP	GENERIC PAVEMENT MARKING ITEM NON-CAST IRON SNOWPLOWABLE PAVEMENT MARKERS	519	EA	
0133	5325200000-E	1510	2" WATER LINE	109	LF	
0134	5325300000-E	1510	3" WATER LINE	6	LF	
0135	5325600000-E	1510	6" WATER LINE	718	LF	
0136	5325800000-E	1510	8" WATER LINE	745	LF	
0137	5326000000-E	1510	10" WATER LINE	8,099	LF	
0138	5326200000-E	1510	12" WATER LINE	375	LF	
0139	5326600000-E	1510	16" WATER LINE	20	LF	
0140	5327000000-E	1510	20" WATER LINE	712	LF	
0141	5329000000-E	1510	DUCTILE IRON WATER PIPE FITTINGS	25,145	LB	
0142	5534000000-E	1515	*** VALVE (3")	1	EA	
0143	5536000000-E	1515	2" VALVE	2	EA	
0144	5540000000-E	1515	6" VALVE	21	EA	

County : Wayne

Line #	Item Number	Sec #	Description	Quantity	Unit Cost	Amount
0145	5546000000-E	1515	8" VALVE	4	EA	
0146	5552000000-E	1515	10" VALVE	20	EA	
0147	5558000000-E	1515	12" VALVE	2	EA	
0148	5558600000-E	1515	16" VALVE	1	EA	
0149	5559000000-E	1515	20" VALVE	2	EA	
0150	5606000000-E	1515	2" BLOW OFF	1	EA	
0151	5648000000-N	1515	RELOCATE WATER METER	56	EA	
0152	5649000000-N	1515	RECONNECT WATER METER	21	EA	
0153	5656100000-E	1515	RELOCATE *** RPZ BACKFLOW PRE-VENTION ASSEMBLY (1")	17	EA	
0154	5656100000-E	1515	RELOCATE *** RPZ BACKFLOW PRE-VENTION ASSEMBLY (2-1/2")	1	EA	
0155	5656210000-E	1515	RELOCATE 2" RPZ BACKFLOW PRE-VENTION ASSEMBLY	2	EA	
0156	5666000000-N	1515	FIRE HYDRANT	12	EA	
0157	5673000000-E	1515	FIRE HYDRANT LEG	94	LF	
0158	5685000000-E	1515	12" LINE STOP WITH BYPASS	4	EA	
0159	5686000000-E	1515	*** WATER SERVICE LINE (2")	371	LF	
0160	5686000000-E	1515	*** WATER SERVICE LINE (2-1/2")	27	LF	
0161	5686500000-E	1515	WATER SERVICE LINE	3,807	LF	
0162	5691300000-E	1520	8" SANITARY GRAVITY SEWER	393	LF	
0163	5691500000-E	1520	12" SANITARY GRAVITY SEWER	125	LF	

County : Wayne

Line #	Item Number	Sec #	Description	Quantity	Unit Cost	Amount
0164	5709400000-E	1520	8" FORCE MAIN SEWER	44 LF		
0165	5709600000-E	1520	12" FORCE MAIN SEWER	1,366 LF		
0166	5768000000-N	1520	SANITARY SEWER CLEAN-OUT	40 EA		
0167	5768500000-E	1520	SEWER SERVICE LINE	1,000 LF		
0168	5769000000-E	1520	DUCTILE IRON SEWER PIPE FITTINGS	4,015 LB		
0169	5775000000-E	1525	4' DIA UTILITY MANHOLE	8 EA		
0170	5781000000-E	1525	UTILITY MANHOLE WALL 4' DIA	11 LF		
0171	5800000000-E	1530	ABANDON 6" UTILITY PIPE	3,004 LF		
0172	5801000000-E	1530	ABANDON 8" UTILITY PIPE	1,437 LF		
0173	5802000000-E	1530	ABANDON 10" UTILITY PIPE	6,255 LF		
0174	5804000000-E	1530	ABANDON 12" UTILITY PIPE	2,505 LF		
0175	5810000000-E	1530	ABANDON 16" UTILITY PIPE	851 LF		
0176	5815000000-N	1530	REMOVE WATER METER	18 EA		
0177	5816000000-N	1530	ABANDON UTILITY MANHOLE	2 EA		
0178	5835600000-E	1540	12" ENCASEMENT PIPE	194 LF		
0179	5835700000-E	1540	16" ENCASEMENT PIPE	90 LF		
0180	5835900000-E	1540	20" ENCASEMENT PIPE	494 LF		
0181	5836000000-E	1540	24" ENCASEMENT PIPE	330 LF		
0182	5872500000-E	1550	BORE AND JACK OF *** (12")	194 LF		
0183	5872500000-E	1550	BORE AND JACK OF *** (16")	90 LF		

County : Wayne

Line #	Item Number	Sec #	Description	Quantity	Unit Cost	Amount
0184	5872500000-E	1550	BORE AND JACK OF *** (20")	494 LF		
0185	5872500000-E	1550	BORE AND JACK OF *** (24")	330 LF		
0186	5882000000-N	SP	GENERIC UTILITY ITEM 8" FLEXIBLE COUPLING	4 EA		
0187	5882000000-N	SP	GENERIC UTILITY ITEM REMOVE AND STOCKPILE EXISTING FIRE HYDRANT	12 EA		
0188	5882000000-N	SP	GENERIC UTILITY ITEM REMOVE BACKFLOW PREVENTION ASSEMBLY	3 EA		
0189	6000000000-E	1605	TEMPORARY SILT FENCE	20,690 LF		
0190	6006000000-E	1610	STONE FOR EROSION CONTROL, CLASS A	585 TON		
0191	6009000000-E	1610	STONE FOR EROSION CONTROL, CLASS B	1,205 TON		
0192	6012000000-E	1610	SEDIMENT CONTROL STONE	2,285 TON		
0193	6015000000-E	1615	TEMPORARY MULCHING	25 ACR		
0194	6018000000-E	1620	SEED FOR TEMPORARY SEEDING	1,600 LB		
0195	6021000000-E	1620	FERTILIZER FOR TEMPORARY SEED- ING	9 TON		
0196	6024000000-E	1622	TEMPORARY SLOPE DRAINS	485 LF		
0197	6029000000-E	SP	SAFETY FENCE	200 LF		
0198	6030000000-E	1630	SILT EXCAVATION	1,850 CY		
0199	6036000000-E	1631	MATTING FOR EROSION CONTROL	8,590 SY		
0200	6037000000-E	SP	COIR FIBER MAT	100 SY		
0201	6042000000-E	1632	1/4" HARDWARE CLOTH	7,260 LF		

County : Wayne

Line #	Item Number	Sec #	Description	Quantity	Unit Cost	Amount
0202	6043000000-E	SP	LOW PERMEABILITY GEOTEXTILE	150		SY
0203	6045000000-E	SP	*** TEMPORARY PIPE (36")	60		LF
0204	6070000000-N	1639	SPECIAL STILLING BASINS	2		EA
0205	6071012000-E	SP	COIR FIBER WATTLE	860		LF
0206	6071020000-E	SP	POLYACRYLAMIDE (PAM)	200		LB
0207	6071030000-E	1640	COIR FIBER BAFFLE	660		LF
0208	6071050000-E	SP	*** SKIMMER (1-1/2")	3		EA
0209	6071050000-E	SP	*** SKIMMER (2")	1		EA
0210	6084000000-E	1660	SEEDING & MULCHING	27		ACR
0211	6087000000-E	1660	MOWING	15		ACR
0212	6090000000-E	1661	SEED FOR REPAIR SEEDING	300		LB
0213	6093000000-E	1661	FERTILIZER FOR REPAIR SEEDING	0.75		TON
0214	6096000000-E	1662	SEED FOR SUPPLEMENTAL SEEDING	600		LB
0215	6108000000-E	1665	FERTILIZER TOPDRESSING	18		TON
0216	6111000000-E	SP	IMPERVIOUS DIKE	46		LF
0217	6114500000-N	1667	SPECIALIZED HAND MOWING	10		MHR
0218	6117000000-N	SP	RESPONSE FOR EROSION CONTROL	25		EA
0219	6117500000-N	SP	CONCRETE WASHOUT STRUCTURE	4		EA
0220	6123000000-E	1670	REFORESTATION	0.25		ACR

County : Wayne

Line #	Item Number	Sec #	Description	Quantity	Unit Cost	Amount
0221	6132000000-N	SP	GENERIC EROSION CONTROL ITEM FABRIC INSERT INLET PROTECTION DEVICE	6 EA		
0222	6132000000-N	SP	GENERIC EROSION CONTROL ITEM FABRIC INSERT INLET PROTECTION DEVICE CLEANOUT	12 EA		
0223	7000000000-E	1705	PEDESTRIAN SIGNAL HEAD (**, ** SECTION) (16", 1 SECTION WITH COUNT- DOWN)	22 EA		
0224	7060000000-E	1705	SIGNAL CABLE	8,243 LF		
0225	7120000000-E	1705	VEHICLE SIGNAL HEAD (12", 3 SECTION)	59 EA		
0226	7132000000-E	1705	VEHICLE SIGNAL HEAD (12", 4 SECTION)	14 EA		
0227	7144000000-E	1705	VEHICLE SIGNAL HEAD (12", 5 SECTION)	3 EA		
0228	7252000000-E	1710	MESSENGER CABLE (1/4")	7,290 LF		
0229	7264000000-E	1710	MESSENGER CABLE (3/8")	3,325 LF		
0230	7300000000-E	1715	UNPAVED TRENCHING (*****) (1, 2")	1,175 LF		
0231	7300000000-E	1715	UNPAVED TRENCHING (*****) (2, 2")	1,900 LF		
0232	7301000000-E	1715	DIRECTIONAL DRILL (*****) (1, 2")	162 LF		
0233	7324000000-N	1716	JUNCTION BOX (STANDARD SIZE)	23 EA		
0234	7348000000-N	1716	JUNCTION BOX (OVER-SIZED, HEA- VY DUTY)	9 EA		
0235	7360000000-N	1720	WOOD POLE	11 EA		
0236	7372000000-N	1721	GUY ASSEMBLY	33 EA		
0237	7408000000-E	1722	1" RISER WITH WEATHERHEAD	3 EA		

County : Wayne

Line #	Item Number	Sec #	Description	Quantity	Unit Cost	Amount
0238	7420000000-E	1722	2" RISER WITH WEATHERHEAD	3 EA		
0239	7430000000-N	1722	HEAT SHRINK TUBING RETROFIT KIT	1 EA		
0240	7432000000-E	1722	2" RISER WITH HEAT SHRINK TUBING	5 EA		
0241	7444000000-E	1725	INDUCTIVE LOOP SAWCUT	3,482 LF		
0242	7456000000-E	1726	LEAD-IN CABLE (***** (14-2)	16,592 LF		
0243	7516000000-E	1730	COMMUNICATIONS CABLE (**FIBER) (24)	9,380 LF		
0244	7540000000-N	1731	SPLICE ENCLOSURE	4 EA		
0245	7541000000-N	1731	MODIFY SPLICE ENCLOSURE	2 EA		
0246	7552000000-N	1731	INTERCONNECT CENTER	4 EA		
0247	7576000000-N	SP	METAL STRAIN SIGNAL POLE	16 EA		
0248	7613000000-N	SP	SOIL TEST	16 EA		
0249	7614100000-E	SP	DRILLED PIER FOUNDATION	112 CY		
0250	7636000000-N	1745	SIGN FOR SIGNALS	8 EA		
0251	7642200000-N	1743	TYPE II PEDESTAL WITH FOUNDATION	22 EA		
0252	7684000000-N	1750	SIGNAL CABINET FOUNDATION	4 EA		
0253	7696000000-N	1751	CONTROLLERS WITH CABINET (***** (2070E, BASE MOUNTED)	4 EA		
0254	7744000000-N	1751	DETECTOR CARD (TYPE 170)	33 EA		
0255	7901000000-N	1753	CABINET BASE EXTENDER	4 EA		

County : Wayne

Line #	Item Number	Sec #	Description	Quantity	Unit Cost	Amount
0256	7980000000-N	SP	GENERIC SIGNAL ITEM MICROWAVE VEHICLE DETECTION SYSTEM - MULTIPLE ZONES	12 EA		

CULVERT ITEMS

0257	8126000000-N	414	CULVERT EXCAVATION, STA ***** (75+49.09 -L-)	Lump Sum	L.S.	
0258	8133000000-E	414	FOUNDATION CONDITIONING MATERIAL, BOX CULVERT	21 TON		
0259	8196000000-E	420	CLASS A CONCRETE (CULVERT)	33.2 CY		
0260	8245000000-E	425	REINFORCING STEEL (CULVERT)	4,117 LB		

1120/Feb12/Q600101.1/D1146453837000/E260

Total Amount Of Bid For Entire Project :

DBE GOAL SET: 13%
DBE GOAL OBT: 13%

Vendor 1 of 3: BRIDGEPOINT CIVIL LLC (15979)
Call Order 004 (Proposal: C204131)

Bid Information

Proposal County: WAYNE	Bid Checksum: 02A8D76DEA
Vendor Address: P.O. BOX 729 PIKEVILLE , NC , 27863	Bid Total: \$15,346,704.64
Signature Check: Jeremy Adam Smith	Items Total: \$15,346,704.64
Time Bid Received: March 17, 2020 01:48 PM	Time Total: \$0.00
Amendment Count: 0	

Bidding Errors:
None.

Vendor 1 of 3: BRIDGEPOINT CIVIL LLC (15979)
Call Order 004 (Proposal: C204131)

Bid Bond Information

Projects:	Bond Maximum:
Counties:	State of Incorporation: Ohio
Bond ID: SNC20170103	Agency Execution Date: 3/11/2020 10
Paid by Check: No	Surety Name: Surety2000
Bond Percent: 5%	Bond Agency Name: Westfield Insurance Company

DBE Load Information

Letting ID: L200317
Letting Date: 03/17/2020
Call Order: 004
Contract ID: C204131
Project: STATE FUNDEDSTATE FUNDEDSTATE FUNDEDSTATE FUNDED
Bid Total: \$15,346,704.64
DBE Goal: 13.00% (\$1,995,071.60)

Vendor ID: 15979
Vendor Name: BridgePoint Civil, LLC
DBE Entered: 13.00% (\$1,995,503.09)

Vendor ID	DBE Name	Is Supplier?	City/State	Goods/Service	Amount
11328	DAVID CHARLES LINCOLN DBA LINCOLNS TRUCKING	D&A False	P.O. BOX 48416, CUMBERLAND, NC 28331	SubContractor	231,648.00 COMMITTED
11110	J M COLLINS HAULING LLC	False	151 NEW CREECH RD, SELMA, NC 27576	SubContractor	49,999.00 COMMITTED
11572	CRUZ BROTHERS CONCRETE, INC.	False	1572 PAYNE ROAD/LOT 75 LOT 75, GRAHAM, NC 27253	SubContractor	1,177,341.00 COMMITTED
12802	NICKELSTON INDUSTRIES INC	False	POST OFFICE BOX 133, LAWSONVILLE, NC 27022	SubContractor	14,853.00 COMMITTED
2976	CAROLINA ENVIRONMENTAL CONTRACTING INC	False	POST OFFICE BOX 1905, MT. AIRY, NC 27030	SubContractor	62,670.00 COMMITTED
11766	EASTERN EARTHSCAPES & CONSTRUCTION	False	3109 NC HWY 222 EAST STANTONSBURG, NC 27883	SubContractor	243,581.00 COMMITTED
11106	J & N HAULING LLC	False	109 MAY DR, SMITHFIELD, NC 27577	SubContractor	30,000.00 COMMITTED
4948	BURTCH TRUCKING CO.	False	605 INDIAN CAMP RD., SMITHFIELD, NC 27577	SubContractor	29,196.00 COMMITTED
101179	NPS Solutions	False	PO Box 58344 Raleigh, NC 27658	SubContractor	156,215.09 COMMITTED

Letting: L200317
03/17/2020 02:00:00 PM

North Carolina Department of Transportation
15979 - BridgePoint Civil, LLC

Contract ID: C204131
Call: 004

BondID: SNC20170103

Surety Registry Agency: Surety2000

Verified?: 1

Surety Agency: Westfield Insurance Company

Bond Execution Date: 3/11/2020 10:06:21 AM

Line Number	Item Number	Quantity	Unit	Unit Price	Extension Price
Section 0001 ROADWAY ITEMS					
0001	0000100000-N MOBILIZATION	1.000	LS	\$690,000.0000	\$690,000.00
0002	0000400000-N CONSTRUCTION SURVEYING	1.000	LS	\$117,037.0000	\$117,037.00
0003	0000915000-N GENERIC MISCELLANEOUS ITEM REMOVE WOOD POLE	127.000	EA	\$115.0000	\$14,605.00
0004	0001000000-E CLEARING & GRUBBING .. ACRE(S)	1.000	LS	\$510,000.0000	\$510,000.00
0005	0008000000-E SUPPLEMENTARY CLEARING & GRUB-BING	1.000	ACR	\$22,722.0000	\$22,722.00
0006	0022000000-E UNCLASSIFIED EXCAVATION	5000.000	CY	\$18.0000	\$90,000.00
0007	0036000000-E UNDERCUT EXCAVATION	1000.000	CY	\$35.0000	\$35,000.00
0008	0106000000-E BORROW EXCAVATION	42000.000	CY	\$5.0000	\$210,000.00
0009	0134000000-E DRAINAGE DITCH EXCAVATION	1240.000	CY	\$8.0000	\$9,920.00
0010	0156000000-E REMOVAL OF EXISTING ASPHALT PAVEMENT	21010.000	SY	\$5.0000	\$105,050.00
0011	0163000000-E REMOVAL OF EXISTING CONCRETE PAVEMENT	1000.000	SY	\$84.0000	\$84,000.00
0012	0177000000-E BREAKING OF EXISTING ASPHALT PAVEMENT	720.000	SY	\$21.0000	\$15,120.00
0013	0195000000-E SELECT GRANULAR MATERIAL	1000.000	CY	\$14.0000	\$14,000.00
0014	0196000000-E GEOTEXTILE FOR SOIL STABILIZA-TION	1700.000	SY	\$5.0000	\$8,500.00
0015	0199000000-E TEMPORARY SHORING	410.000	SF	\$41.0000	\$16,810.00
0016	0255000000-E GENERIC GRADING ITEM HAULING AND DISPOSAL OF PETROLEUM CONTAMINATED SOIL	300.000	TON	\$69.0000	\$20,700.00
0017	0318000000-E FOUNDATION CONDITIONING MATE- RIAL, MINOR STRUCTURES	2200.000	TON	\$36.0000	\$79,200.00
0018	0320000000-E FOUNDATION CONDITIONING GEO- TEXTILE	6400.000	SY	\$5.0000	\$32,000.00
0019	0335500000-E 30" DRAINAGE PIPE	24.000	LF	\$82.0000	\$1,968.00
0020	0335850000-E **" DRAINAGE PIPE ELBOWS (30")	2.000	EA	\$400.0000	\$800.00
0021	0366000000-E 15" RC PIPE CULVERTS, CLASS III	692.000	LF	\$33.0000	\$22,836.00
0022	0372000000-E 18" RC PIPE CULVERTS, CLASS III	1128.000	LF	\$41.0000	\$46,248.00
0023	0378000000-E 24" RC PIPE CULVERTS, CLASS III	300.000	LF	\$56.0000	\$16,800.00

0024	0384000000-E	412.000	LF	\$73.0000	\$30,076.00
	30" RC PIPE CULVERTS, CLASS III				
0025	0390000000-E	232.000	LF	\$104.0000	\$24,128.00
	36" RC PIPE CULVERTS, CLASS III				
0026	0396000000-E	56.000	LF	\$154.0000	\$8,624.00
	42" RC PIPE CULVERTS, CLASS III				
0027	0448000000-E	108.000	LF	\$40.0000	\$4,320.00
	****" RC PIPE CULVERTS, CLASS IV (12")				
0028	0448200000-E	324.000	LF	\$41.0000	\$13,284.00
	15" RC PIPE CULVERTS, CLASS IV				
0029	0448300000-E	7300.000	LF	\$45.0000	\$328,500.00
	18" RC PIPE CULVERTS, CLASS IV				
0030	0448400000-E	640.000	LF	\$69.0000	\$44,160.00
	24" RC PIPE CULVERTS, CLASS IV				
0031	0448500000-E	268.000	LF	\$100.0000	\$26,800.00
	30" RC PIPE CULVERTS, CLASS IV				
0032	0448600000-E	1168.000	LF	\$138.0000	\$161,184.00
	36" RC PIPE CULVERTS, CLASS IV				
0033	0448700000-E	548.000	LF	\$203.0000	\$111,244.00
	42" RC PIPE CULVERTS, CLASS IV				
0034	0995000000-E	4392.000	LF	\$16.0000	\$70,272.00
	PIPE REMOVAL				
0035	0996000000-N	1.000	EA	\$1,500.0000	\$1,500.00
	PIPE CLEAN OUT				
0036	1011000000-N	1.000	LS	\$942,419.0000	\$942,419.00
	FINE GRADING				
0037	1099500000-E	500.000	CY	\$18.0000	\$9,000.00
	SHALLOW UNDERCUT				
0038	1099700000-E	1000.000	TON	\$24.0000	\$24,000.00
	CLASS IV SUBGRADE STABILIZATION				
0039	1121000000-E	2633.000	TON	\$23.0000	\$60,559.00
	AGGREGATE BASE COURSE				
0040	1220000000-E	800.000	TON	\$39.0000	\$31,200.00
	INCIDENTAL STONE BASE				
0041	1297000000-E	5350.000	SY	\$8.0000	\$42,800.00
	MILLING ASPHALT PAVEMENT, ****"DEPTH (1-1/2")				
0042	1330000000-E	2060.000	SY	\$10.0000	\$20,600.00
	INCIDENTAL MILLING				
0043	1491000000-E	19850.000	TON	\$64.0000	\$1,270,400.00
	ASPHALT CONC BASE COURSE, TYPE B25.0C				
0044	1503000000-E	16960.000	TON	\$65.0000	\$1,102,400.00
	ASPHALT CONC INTERMEDIATE COURSE, TYPE I19.0C				
0045	1519000000-E	14430.000	TON	\$66.0000	\$952,380.00
	ASPHALT CONC SURFACE COURSE, TYPE S9.5B				
0046	1575000000-E	2675.000	TON	\$450.0000	\$1,203,750.00
	ASPHALT BINDER FOR PLANT MIX				
0047	1693000000-E	1840.000	TON	\$172.0000	\$316,480.00
	ASPHALT PLANT MIX, PAVEMENT REPAIR				
0048	1704000000-E	335.000	TON	\$143.0000	\$47,905.00

PATCHING EXISTING PAVEMENT					
0049	2022000000-E	896.000	CY	\$22.0000	\$19,712.00
	SUBDRAIN EXCAVATION				
0050	2033000000-E	672.000	CY	\$68.0000	\$45,696.00
	SUBDRAIN FINE AGGREGATE				
0051	2044000000-E	4000.000	LF	\$16.0000	\$64,000.00
	6" PERFORATED SUBDRAIN PIPE				
0052	2070000000-N	8.000	EA	\$448.0000	\$3,584.00
	SUBDRAIN PIPE OUTLET				
0053	2077000000-E	48.000	LF	\$56.0000	\$2,688.00
	6" OUTLET PIPE				
0054	2209000000-E	3.400	CY	\$1,800.0000	\$6,120.00
	ENDWALLS				
0055	2264000000-E	3.100	CY	\$1,900.0000	\$5,890.00
	PIPE PLUGS				
0056	2275000000-E	11.000	CY	\$287.0000	\$3,157.00
	FLOWABLE FILL				
0057	2286000000-N	182.000	EA	\$1,600.0000	\$291,200.00
	MASONRY DRAINAGE STRUCTURES				
0058	2308000000-E	63.400	LF	\$370.0000	\$23,458.00
	MASONRY DRAINAGE STRUCTURES				
0059	2364000000-N	36.000	EA	\$670.0000	\$24,120.00
	FRAME WITH TWO GRATES, STD 840.16				
0060	2366000000-N	1.000	EA	\$884.0000	\$884.00
	FRAME WITH TWO GRATES, STD 840.24				
0061	2374000000-N	27.000	EA	\$884.0000	\$23,868.00
	FRAME WITH GRATE & HOOD, STD 840.03, TYPE ** (E)				
0062	2374000000-N	51.000	EA	\$958.0000	\$48,858.00
	FRAME WITH GRATE & HOOD, STD 840.03, TYPE ** (F)				
0063	2374000000-N	55.000	EA	\$964.0000	\$53,020.00
	FRAME WITH GRATE & HOOD, STD 840.03, TYPE ** (G)				
0064	2396000000-N	11.000	EA	\$671.0000	\$7,381.00
	FRAME WITH COVER, STD 840.54				
0065	2440000000-N	13.000	EA	\$1,700.0000	\$22,100.00
	CONCRETE TRANSITIONAL SECTION FOR CATCH BASIN				
0066	2451000000-N	13.000	EA	\$1,700.0000	\$22,100.00
	CONCRETE TRANSITIONAL SECTION FOR DROP INLET				
0067	2535000000-E	240.000	LF	\$28.0000	\$6,720.00
	**"X **" CONCRETE CURB (8" X 18")				
0068	2538000000-E	5470.000	LF	\$27.0000	\$147,690.00
	'-" CONCRETE CURB & GUTTER (2'-9")				
0069	2549000000-E	16910.000	LF	\$25.0000	\$422,750.00
	2'-6" CONCRETE CURB & GUTTER				
0070	2591000000-E	4220.000	SY	\$49.0000	\$206,780.00
	4" CONCRETE SIDEWALK				
0071	2605000000-N	120.000	EA	\$2,181.0000	\$261,720.00
	CONCRETE CURB RAMPS				
0072	2612000000-E	840.000	SY	\$92.0000	\$77,280.00
	6" CONCRETE DRIVEWAY				

0073	2619000000-E	31.000 SY		\$120.0000	\$3,720.00
	4" CONCRETE PAVED DITCH				
0074	2655000000-E	2750.000 SY		\$69.0000	\$189,750.00
	5" MONOLITHIC CONCRETE ISLANDS (KEYED IN)				
0075	2815000000-N	1.000 EA		\$721.0000	\$721.00
	ADJUSTMENT OF DROP INLETS				
0076	2830000000-N	1.000 EA		\$1,472.0000	\$1,472.00
	ADJUSTMENT OF MANHOLES				
0077	3030000000-E	475.000 LF		\$16.0000	\$7,600.00
	STEEL BEAM GUARDRAIL				
0078	3150000000-N	5.000 EA		\$34.0000	\$170.00
	ADDITIONAL GUARDRAIL POSTS				
0079	3210000000-N	2.000 EA		\$574.0000	\$1,148.00
	GUARDRAIL END UNITS, TYPE CAT-1				
0080	3287000000-N	2.000 EA		\$3,043.0000	\$6,086.00
	GUARDRAIL END UNITS, TYPE TL-3				
0081	3360000000-E	630.000 LF		\$1.0000	\$630.00
	REMOVE EXISTING GUARDRAIL				
0082	3628000000-E	45.000 TON		\$37.0000	\$1,665.00
	RIP RAP, CLASS I				
0083	3649000000-E	75.000 TON		\$38.0000	\$2,850.00
	RIP RAP, CLASS B				
0084	3656000000-E	975.000 SY		\$6.0000	\$5,850.00
	GEOTEXTILE FOR DRAINAGE				
0085	4025000000-E	38.000 SF		\$7.0000	\$266.00
	CONTRACTOR FURNISHED, TYPE ***SIGN (A)				
0086	4025000000-E	30.000 SF		\$8.0000	\$240.00
	CONTRACTOR FURNISHED, TYPE ***SIGN (B)				
0087	4025000000-E	143.000 SF		\$12.0000	\$1,716.00
	CONTRACTOR FURNISHED, TYPE ***SIGN (D)				
0088	4025000000-E	755.000 SF		\$18.0000	\$13,590.00
	CONTRACTOR FURNISHED, TYPE ***SIGN (E)				
0089	4025000000-E	384.000 SF		\$26.0000	\$9,984.00
	CONTRACTOR FURNISHED, TYPE ***SIGN (F)				
0090	4054000000-E	1.000 CY		\$370.0000	\$370.00
	PLAIN CONCRETE SIGN FOUNDATIONS				
0091	4060000000-E	225.000 LB		\$5.0000	\$1,125.00
	SUPPORTS, BREAKAWAY STEEL BEAM				
0092	4072000000-E	2700.000 LF		\$8.0000	\$21,600.00
	SUPPORTS, 3-LB STEEL U-CHANNEL				
0093	4096000000-N	10.000 EA		\$115.0000	\$1,150.00
	SIGN ERECTION, TYPE D				
0094	4102000000-N	121.000 EA		\$52.0000	\$6,292.00
	SIGN ERECTION, TYPE E				
0095	4108000000-N	27.000 EA		\$103.0000	\$2,781.00
	SIGN ERECTION, TYPE F				
0096	4110000000-N	1.000 EA		\$1,723.0000	\$1,723.00
	SIGN ERECTION, TYPE *** (GROUND MOUNTED) (A)				
0097	4110000000-N	1.000 EA		\$2,010.0000	\$2,010.00

	SIGN ERECTION, TYPE ***	(GROUND MOUNTED) (B)		
0098	4152000000-N DISPOSAL OF SIGN SYSTEM, STEELBEAM	1.000 EA	\$919.0000	\$919.00
0099	4158000000-N DISPOSAL OF SIGN SYSTEM, WOOD	100.000 EA	\$29.0000	\$2,900.00
0100	4400000000-E WORK ZONE SIGNS (STATIONARY)	691.000 SF	\$7.0000	\$4,837.00
0101	4405000000-E WORK ZONE SIGNS (PORTABLE)	197.000 SF	\$10.0000	\$1,970.00
0102	4410000000-E WORK ZONE SIGNS (BARRICADE MOUNTED)	184.000 SF	\$7.0000	\$1,288.00
0103	4415000000-N FLASHING ARROW BOARD	3.000 EA	\$3,674.0000	\$11,022.00
0104	4420000000-N PORTABLE CHANGEABLE MESSAGE SIGN	4.000 EA	\$9,646.0000	\$38,584.00
0105	4430000000-N DRUMS	651.000 EA	\$44.0000	\$28,644.00
0106	4445000000-E BARRICADES (TYPE III)	128.000 LF	\$29.0000	\$3,712.00
0107	4447000000-E PEDESTRIAN CHANNELIZING DEVICES	60.000 LF	\$34.0000	\$2,040.00
0108	4455000000-N FLAGGER	20.000 DAY	\$1,378.0000	\$27,560.00
0109	4480000000-N TMA	4.000 EA	\$13,780.0000	\$55,120.00
0110	4507000000-E WATER FILLED BARRIER	500.000 LF	\$84.0000	\$42,000.00
0111	4510000000-N LAW ENFORCEMENT	104.000 HR	\$63.0000	\$6,552.00
0112	4650000000-N TEMPORARY RAISED PAVEMENT MARKERS	619.000 EA	\$5.0000	\$3,095.00
0113	4685000000-E THERMOPLASTIC PAVEMENT MARKING LINES (4", 90 MILS)	32582.000 LF	\$1.0000	\$32,582.00
0114	4688000000-E THERMOPLASTIC PAVEMENT MARKING LINES (6", 90 MILS)	201.000 LF	\$1.2000	\$241.20
0115	4695000000-E THERMOPLASTIC PAVEMENT MARKING LINES (8", 90 MILS)	3713.000 LF	\$2.0000	\$7,426.00
0116	4700000000-E THERMOPLASTIC PAVEMENT MARKING LINES (12", 90 MILS)	39.000 LF	\$2.0000	\$78.00
0117	4720000000-E THERMOPLASTIC PAVEMENT MARKING CHARACTER (90 MILS)	10.000 EA	\$175.0000	\$1,750.00
0118	4725000000-E THERMOPLASTIC PAVEMENT MARKING SYMBOL (90 MILS)	122.000 EA	\$109.0000	\$13,298.00
0119	4810000000-E PAINT PAVEMENT MARKING LINES (4")	134080.000 LF	\$0.2500	\$33,520.00
0120	4820000000-E PAINT PAVEMENT MARKING LINES (8")	3358.000 LF	\$0.5200	\$1,746.16
0121	4825000000-E PAINT PAVEMENT MARKING LINES (12")	1462.000 LF	\$1.0000	\$1,462.00

0122	4835000000-E	1808.000	LF	\$3.0000	\$5,424.00
	PAINT PAVEMENT MARKING LINES (24")				
0123	4840000000-N	40.000	EA	\$37.0000	\$1,480.00
	PAINT PAVEMENT MARKING CHARAC-TER				
0124	4845000000-N	232.000	EA	\$37.0000	\$8,584.00
	PAINT PAVEMENT MARKING SYMBOL				
0125	4850000000-E	35322.000	LF	\$0.7400	\$26,138.28
	REMOVAL OF PAVEMENT MARKING LINES (4")				
0126	4860000000-E	410.000	LF	\$1.6500	\$676.50
	REMOVAL OF PAVEMENT MARKING LINES (8")				
0127	4865000000-E	367.000	LF	\$2.0000	\$734.00
	REMOVAL OF PAVEMENT MARKING LINES (12")				
0128	4870000000-E	555.000	LF	\$5.5000	\$3,052.50
	REMOVAL OF PAVEMENT MARKING LINES (24")				
0129	4875000000-N	66.000	EA	\$90.0000	\$5,940.00
	REMOVAL OF PAVEMENT MARKING SYMBOLS & CHARACTERS				
0130	4891000000-E	45.000	LF	\$5.0000	\$225.00
	GENERIC PAVEMENT MARKING ITEM THERMOPLASTIC PAVEMENT MARKING LINES (16", 90 MILS)				
0131	4891000000-E	706.000	LF	\$11.0000	\$7,766.00
	GENERIC PAVEMENT MARKING ITEM THERMOPLASTIC PAVEMENT MARKING LINES (24", 90 MILS)				
0132	4895000000-N	519.000	EA	\$30.0000	\$15,570.00
	GENERIC PAVEMENT MARKING ITEM NON-CAST IRON SNOWPLOWABLE PAVEMENT MARKERS				
0133	5325200000-E	109.000	LF	\$38.0000	\$4,142.00
	2" WATER LINE				
0134	5325300000-E	6.000	LF	\$192.0000	\$1,152.00
	3" WATER LINE				
0135	5325600000-E	718.000	LF	\$32.0000	\$22,976.00
	6" WATER LINE				
0136	5325800000-E	745.000	LF	\$47.0000	\$35,015.00
	8" WATER LINE				
0137	5326000000-E	8099.000	LF	\$61.0000	\$494,039.00
	10" WATER LINE				
0138	5326200000-E	375.000	LF	\$74.0000	\$27,750.00
	12" WATER LINE				
0139	5326600000-E	20.000	LF	\$222.0000	\$4,440.00
	16" WATER LINE				
0140	5327000000-E	712.000	LF	\$166.0000	\$118,192.00
	20" WATER LINE				
0141	5329000000-E	25145.000	LB	\$9.0000	\$226,305.00
	DUCTILE IRON WATER PIPE FITTINGS				
0142	5534000000-E	1.000	EA	\$1,430.0000	\$1,430.00
	*** VALVE (3")				
0143	5536000000-E	2.000	EA	\$761.0000	\$1,522.00
	2" VALVE				
0144	5540000000-E	21.000	EA	\$1,477.0000	\$31,017.00
	6" VALVE				
0145	5546000000-E	4.000	EA	\$1,689.0000	\$6,756.00

	8" VALVE				
0146	5552000000-E	20.000 EA	\$2,390.0000	\$47,800.00	
	10" VALVE				
0147	5558000000-E	2.000 EA	\$2,861.0000	\$5,722.00	
	12" VALVE				
0148	5558600000-E	1.000 EA	\$4,406.0000	\$4,406.00	
	16" VALVE				
0149	5559000000-E	2.000 EA	\$6,451.0000	\$12,902.00	
	20" VALVE				
0150	5606000000-E	1.000 EA	\$1,668.0000	\$1,668.00	
	2" BLOW OFF				
0151	5648000000-N	56.000 EA	\$1,209.0000	\$67,704.00	
	RELOCATE WATER METER				
0152	5649000000-N	21.000 EA	\$549.0000	\$11,529.00	
	RECONNECT WATER METER				
0153	5656100000-E	17.000 EA	\$4,244.0000	\$72,148.00	
	RELOCATE *** RPZ BACKFLOW PRE-VENTION ASSEMBLY (1")				
0154	5656100000-E	1.000 EA	\$6,941.0000	\$6,941.00	
	RELOCATE *** RPZ BACKFLOW PRE-VENTION ASSEMBLY (2-1/2")				
0155	5656210000-E	2.000 EA	\$4,822.0000	\$9,644.00	
	RELOCATE 2" RPZ BACKFLOW PRE-VENTION ASSEMBLY				
0156	5666000000-N	12.000 EA	\$4,713.0000	\$56,556.00	
	FIRE HYDRANT				
0157	5673000000-E	94.000 LF	\$70.0000	\$6,580.00	
	FIRE HYDRANT LEG				
0158	5685000000-E	4.000 EA	\$18,876.0000	\$75,504.00	
	12" LINE STOP WITH BYPASS				
0159	5686000000-E	371.000 LF	\$37.0000	\$13,727.00	
	*** WATER SERVICE LINE (2")				
0160	5686000000-E	27.000 LF	\$60.0000	\$1,620.00	
	*** WATER SERVICE LINE (2-1/2")				
0161	5686500000-E	3807.000 LF	\$22.0000	\$83,754.00	
	WATER SERVICE LINE				
0162	5691300000-E	393.000 LF	\$90.0000	\$35,370.00	
	8" SANITARY GRAVITY SEWER				
0163	5691500000-E	125.000 LF	\$45.0000	\$5,625.00	
	12" SANITARY GRAVITY SEWER				
0164	5709400000-E	44.000 LF	\$79.0000	\$3,476.00	
	8" FORCE MAIN SEWER				
0165	5709600000-E	1366.000 LF	\$77.0000	\$105,182.00	
	12" FORCE MAIN SEWER				
0166	5768000000-N	40.000 EA	\$4,137.0000	\$165,480.00	
	SANITARY SEWER CLEAN-OUT				
0167	5768500000-E	1000.000 LF	\$71.0000	\$71,000.00	
	SEWER SERVICE LINE				
0168	5769000000-E	4015.000 LB	\$15.0000	\$60,225.00	
	DUCTILE IRON SEWER PIPE FITTINGS				
0169	5775000000-E	8.000 EA	\$3,346.0000	\$26,768.00	
	4' DIA UTILITY MANHOLE				

0170	5781000000-E	11.000	LF	\$202.0000	\$2,222.00
	UTILITY MANHOLE WALL 4' DIA				
0171	5800000000-E	3004.000	LF	\$7.0000	\$21,028.00
	ABANDON 6" UTILITY PIPE				
0172	5801000000-E	1437.000	LF	\$9.0000	\$12,933.00
	ABANDON 8" UTILITY PIPE				
0173	5802000000-E	6255.000	LF	\$12.0000	\$75,060.00
	ABANDON 10" UTILITY PIPE				
0174	5804000000-E	2505.000	LF	\$18.0000	\$45,090.00
	ABANDON 12" UTILITY PIPE				
0175	5810000000-E	851.000	LF	\$34.0000	\$28,934.00
	ABANDON 16" UTILITY PIPE				
0176	5815000000-N	18.000	EA	\$431.0000	\$7,758.00
	REMOVE WATER METER				
0177	5816000000-N	2.000	EA	\$2,908.0000	\$5,816.00
	ABANDON UTILITY MANHOLE				
0178	5835600000-E	194.000	LF	\$34.0000	\$6,596.00
	12" ENCASEMENT PIPE				
0179	5835700000-E	90.000	LF	\$57.0000	\$5,130.00
	16" ENCASEMENT PIPE				
0180	5835900000-E	494.000	LF	\$60.0000	\$29,640.00
	20" ENCASEMENT PIPE				
0181	5836000000-E	330.000	LF	\$83.0000	\$27,390.00
	24" ENCASEMENT PIPE				
0182	5872500000-E	194.000	LF	\$143.0000	\$27,742.00
	BORE AND JACK OF *** (12")				
0183	5872500000-E	90.000	LF	\$143.0000	\$12,870.00
	BORE AND JACK OF *** (16")				
0184	5872500000-E	494.000	LF	\$166.0000	\$82,004.00
	BORE AND JACK OF *** (20")				
0185	5872500000-E	330.000	LF	\$212.0000	\$69,960.00
	BORE AND JACK OF *** (24")				
0186	5882000000-N	4.000	EA	\$100.0000	\$400.00
	GENERIC UTILITY ITEM 8" FLEXIBLE COUPLING				
0187	5882000000-N	12.000	EA	\$421.0000	\$5,052.00
	GENERIC UTILITY ITEM REMOVE AND STOCKPILE EXISTING FIRE HYDRANT				
0188	5882000000-N	3.000	EA	\$380.0000	\$1,140.00
	GENERIC UTILITY ITEM REMOVE BACKFLOW PREVENTION ASSEMBLY				
0189	6000000000-E	20690.000	LF	\$3.0000	\$62,070.00
	TEMPORARY SILT FENCE				
0190	6006000000-E	585.000	TON	\$39.0000	\$22,815.00
	STONE FOR EROSION CONTROL, CLASS A				
0191	6009000000-E	1205.000	TON	\$40.0000	\$48,200.00
	STONE FOR EROSION CONTROL, CLASS B				
0192	6012000000-E	2285.000	TON	\$27.0000	\$61,695.00
	SEDIMENT CONTROL STONE				
0193	6015000000-E	25.000	ACR	\$2,270.0000	\$56,750.00
	TEMPORARY MULCHING				
0194	6018000000-E	1600.000	LB	\$8.0000	\$12,800.00

SEED FOR TEMPORARY SEEDING					
0195	6021000000-E	9.000 TON		\$1,010.0000	\$9,090.00
	FERTILIZER FOR TEMPORARY SEED-ING				
0196	6024000000-E	485.000 LF		\$32.0000	\$15,520.00
	TEMPORARY SLOPE DRAINS				
0197	6029000000-E	200.000 LF		\$3.0000	\$600.00
	SAFETY FENCE				
0198	6030000000-E	1850.000 CY		\$9.0000	\$16,650.00
	SILT EXCAVATION				
0199	6036000000-E	8590.000 SY		\$3.0000	\$25,770.00
	MATTING FOR EROSION CONTROL				
0200	6037000000-E	100.000 SY		\$6.0000	\$600.00
	COIR FIBER MAT				
0201	6042000000-E	7260.000 LF		\$5.0000	\$36,300.00
	1/4" HARDWARE CLOTH				
0202	6043000000-E	150.000 SY		\$7.0000	\$1,050.00
	LOW PERMEABILITY GEOTEXTILE				
0203	6045000000-E	60.000 LF		\$98.0000	\$5,880.00
	**" TEMPORARY PIPE (36")				
0204	6070000000-N	2.000 EA		\$634.0000	\$1,268.00
	SPECIAL STILLING BASINS				
0205	6071012000-E	860.000 LF		\$18.0000	\$15,480.00
	COIR FIBER WATTLE				
0206	6071020000-E	200.000 LB		\$8.0000	\$1,600.00
	POLYACRYLAMIDE (PAM)				
0207	6071030000-E	660.000 LF		\$5.0000	\$3,300.00
	COIR FIBER BAFFLE				
0208	6071050000-E	3.000 EA		\$1,361.0000	\$4,083.00
	**" SKIMMER (1-1/2")				
0209	6071050000-E	1.000 EA		\$2,154.0000	\$2,154.00
	**" SKIMMER (2")				
0210	6084000000-E	27.000 ACR		\$4,500.0000	\$121,500.00
	SEEDING & MULCHING				
0211	6087000000-E	15.000 ACR		\$200.0000	\$3,000.00
	MOWING				
0212	6090000000-E	300.000 LB		\$13.0000	\$3,900.00
	SEED FOR REPAIR SEEDING				
0213	6093000000-E	0.750 TON		\$1,100.0000	\$825.00
	FERTILIZER FOR REPAIR SEEDING				
0214	6096000000-E	600.000 LB		\$13.0000	\$7,800.00
	SEED FOR SUPPLEMENTAL SEEDING				
0215	6108000000-E	18.000 TON		\$574.0000	\$10,332.00
	FERTILIZER TOPDRESSING				
0216	6111000000-E	46.000 LF		\$63.0000	\$2,898.00
	IMPERVIOUS DIKE				
0217	6114500000-N	10.000 MHR		\$115.0000	\$1,150.00
	SPECIALIZED HAND MOWING				
0218	6117000000-N	25.000 EA		\$1,200.0000	\$30,000.00
	RESPONSE FOR EROSION CONTROL				

0219	6117500000-N	4.000	EA	\$1,320.0000	\$5,280.00
	CONCRETE WASHOUT STRUCTURE				
0220	6123000000-E	0.250	ACR	\$8,000.0000	\$2,000.00
	REFORESTATION				
0221	6132000000-N	6.000	EA	\$375.0000	\$2,250.00
	GENERIC EROSION CONTROL ITEM FABRIC INSERT INLET PROTECTION DEVICE				
0222	6132000000-N	12.000	EA	\$280.0000	\$3,360.00
	GENERIC EROSION CONTROL ITEM FABRIC INSERT INLET PROTECTION DEVICE CLEANOUT				
0223	7000000000-E	22.000	EA	\$815.0000	\$17,930.00
	PEDESTRIAN SIGNAL HEAD (**", ** SECTION) (16", 1 SECTION WITH COUNT-DOWN)				
0224	7060000000-E	8243.000	LF	\$4.0000	\$32,972.00
	SIGNAL CABLE				
0225	7120000000-E	59.000	EA	\$804.0000	\$47,436.00
	VEHICLE SIGNAL HEAD (12", 3 SECTION)				
0226	7132000000-E	14.000	EA	\$947.0000	\$13,258.00
	VEHICLE SIGNAL HEAD (12", 4 SECTION)				
0227	7144000000-E	3.000	EA	\$1,177.0000	\$3,531.00
	VEHICLE SIGNAL HEAD (12", 5 SECTION)				
0228	7252000000-E	7290.000	LF	\$2.0000	\$14,580.00
	MESSENGER CABLE (1/4")				
0229	7264000000-E	3325.000	LF	\$4.0000	\$13,300.00
	MESSENGER CABLE (3/8")				
0230	7300000000-E	1175.000	LF	\$6.0000	\$7,050.00
	UNPAVED TRENCHING (***** (1, 2"))				
0231	7300000000-E	1900.000	LF	\$8.0000	\$15,200.00
	UNPAVED TRENCHING (***** (2, 2"))				
0232	7301000000-E	162.000	LF	\$21.0000	\$3,402.00
	DIRECTIONAL DRILL (***** (1, 2"))				
0233	7324000000-N	23.000	EA	\$316.0000	\$7,268.00
	JUNCTION BOX (STANDARD SIZE)				
0234	7348000000-N	9.000	EA	\$574.0000	\$5,166.00
	JUNCTION BOX (OVER-SIZED, HEA-VY DUTY)				
0235	7360000000-N	11.000	EA	\$917.0000	\$10,087.00
	WOOD POLE				
0236	7372000000-N	33.000	EA	\$287.0000	\$9,471.00
	GUY ASSEMBLY				
0237	7408000000-E	3.000	EA	\$1.0000	\$3.00
	1" RISER WITH WEATHERHEAD				
0238	7420000000-E	3.000	EA	\$345.0000	\$1,035.00
	2" RISER WITH WEATHERHEAD				
0239	7430000000-N	1.000	EA	\$143.0000	\$143.00
	HEAT SHRINK TUBING RETROFIT KIT				
0240	7432000000-E	5.000	EA	\$545.0000	\$2,725.00
	2" RISER WITH HEAT SHRINK TUBING				
0241	7444000000-E	3482.000	LF	\$6.0000	\$20,892.00
	INDUCTIVE LOOP SAWCUT				
0242	7456000000-E	16592.000	LF	\$1.0000	\$16,592.00
	LEAD-IN CABLE (***** (14-2)				
0243	7516000000-E	9380.000	LF	\$2.0000	\$18,760.00

COMMUNICATIONS CABLE (**FIBER) (24)					
0244	7540000000-N	4.000	EA	\$2,067.0000	\$8,268.00
	SPLICE ENCLOSURE				
0245	7541000000-N	2.000	EA	\$1,263.0000	\$2,526.00
	MODIFY SPLICE ENCLOSURE				
0246	7552000000-N	4.000	EA	\$1,866.0000	\$7,464.00
	INTERCONNECT CENTER				
0247	7576000000-N	16.000	EA	\$11,483.0000	\$183,728.00
	METAL STRAIN SIGNAL POLE				
0248	7613000000-N	16.000	EA	\$1,033.0000	\$16,528.00
	SOIL TEST				
0249	7614100000-E	112.000	CY	\$833.0000	\$93,296.00
	DRILLED PIER FOUNDATION				
0250	7636000000-N	8.000	EA	\$488.0000	\$3,904.00
	SIGN FOR SIGNALS				
0251	7642200000-N	22.000	EA	\$1,837.0000	\$40,414.00
	TYPE II PEDESTAL WITH FOUND- ATION				
0252	7684000000-N	4.000	EA	\$689.0000	\$2,756.00
	SIGNAL CABINET FOUNDATION				
0253	7696000000-N	4.000	EA	\$17,225.0000	\$68,900.00
	CONTROLLERS WITH CABINET (***** (2070E, BASE MOUNTED)				
0254	7744000000-N	33.000	EA	\$132.0000	\$4,356.00
	DETECTOR CARD (TYPE 170)				
0255	7901000000-N	4.000	EA	\$344.0000	\$1,376.00
	CABINET BASE EXTENDER				
0256	7980000000-N	12.000	EA	\$9,184.0000	\$110,208.00
	GENERIC SIGNAL ITEM MICROWAVE VEHICLE DETECTION SYSTEM - MULTIPLE ZONES				
Section 0001 Total					\$15,279,849.64
Section 0002 CULVERT ITEMS					
0257	8126000000-N	1.000	LS	\$13,751.0000	\$13,751.00
	CULVERT EXCAVATION, STA ***** (75+49.09 -L-)				
0258	8133000000-E	21.000	TON	\$34.0000	\$714.00
	FOUNDATION CONDITIONING MATERIAL, BOX CULVERT				
0259	8196000000-E	33.200	CY	\$1,330.0000	\$44,156.00
	CLASS A CONCRETE (CULVERT)				
0260	8245000000-E	4117.000	LB	\$2.0000	\$8,234.00
	REINFORCING STEEL (CULVERT)				
Section 0002 Total					\$66,855.00
Item Total					\$15,346,704.64

ELECTRONIC BID SUBMISSION

By submitting this bid electronically, I hereby acknowledge that all requirements included in the hard copy proposal, addendum, amendments, plans, standard specifications, supplemental specifications and special provisions are part of the bid and contract. Further, I acknowledge that I have read, understand, accept, acknowledge and agree to comply with all statements in this electronic bid.

=====

NON-COLLUSION, DEBARMENT AND GIFT BAN CERTIFICATION

The prequalified bidder declares (or certifies, verifies, or states) under penalty of perjury under the laws of the United States that neither he, nor any official, agent or employee has entered into any agreement, participated in any collusion, or otherwise taken any action which is in restraint of free competitive bidding in connection with any bid or contract, that the prequalified bidder has not been convicted of violating N.C.G.S. §133-24 within the last three years, and that the prequalified bidder intends to do the work with his own bonafide employees or subcontractors and will not bid for the benefit of another contractor.

By submitting this non-collusion, debarment and gift ban certification, the Contractor is attesting his status under penalty of perjury under the laws of the United States in accordance with the Debarment Certification attached, provided that the Debarment Certification also includes any required statements concerning exceptions that are applicable.

N.C.G.S. §133-32 and Executive Order 24 prohibit the offer to, or acceptance by, any State Employee of any gift from anyone with a contract with the State, or from any person seeking to do business with the State. By execution of any response in this procurement, you attest, for your entire organization and its employees or agents, that you are not aware that any such gift has been offered, accepted, or promised by any employees of your organization.

DEBARMENT CERTIFICATION OF PREQUALIFIED BIDDER

Conditions for certification:

1. The prequalified bidder shall provide immediate written notice to the Department if at any time the bidder learns that his certification was erroneous when he submitted his debarment certification or explanation that is file with the Department, or has become erroneous because of changed circumstances.
2. The terms covered transaction, debarred, suspended, ineligible, lower tier

covered transaction, participant, person, primary covered transaction, principal, proposal, and voluntarily excluded, as used in this provision, have the meanings set out in the Definitions and Coverage sections of the rules implementing Executive Order 12549. A copy of the Federal Rules requiring this certification and detailing the definitions and coverages may be obtained from the Contract Officer of the Department.

3. The prequalified bidder agrees by submitting this form, that he will not knowingly enter into any lower tier covered transaction with a person who is debarred, suspended, declared ineligible, or voluntarily excluded from participation in NCDOT contracts, unless authorized by the Department.

4. For Federal Aid projects, the prequalified bidder further agrees that by submitting this form he will include the Federal- Aid Provision titled Required Contract Provisions Federal-Aid Construction Contract (Form FHWA PR 1273) provided by the Department, without subsequent modification, in all lower tier covered transactions.

5. The prequalified bidder may rely upon a certification of a participant in a lower tier covered transaction that he is not debarred, suspended, ineligible, or voluntarily excluded from the covered transaction, unless he knows that the certification is erroneous. The bidder may decide the method and frequency by which he will determine the eligibility of his subcontractors.

6. Nothing contained in the foregoing shall be construed to require establishment of a system of records in order to render in good faith the certification required by this provision. The knowledge and information of a participant is not required to exceed that which is normally possessed by a prudent person in the ordinary course of business dealings.

7. Except as authorized in paragraph 6 herein, the Department may terminate any contract if the bidder knowingly enters into a lower tier covered transaction with a person who is suspended, debarred, ineligible, or voluntarily excluded from participation in this transaction, in addition to other remedies available by the Federal Government.

DEBARMENT CERTIFICATION

The prequalified bidder certifies to the best of his knowledge and belief, that he and his principals:

a. Are not presently debarred, suspended, proposed for debarment, declared ineligible, or voluntarily excluded from covered transactions by any Federal department or agency;

b. Have not within a three-year period preceding this proposal been convicted of or had a civil judgment rendered against them for commission of fraud or a criminal offense in connection with obtaining, attempting to obtain, or performing a public (Federal, State or local) transaction or contract under a public transaction; violation of Federal or State antitrust statutes or

commission of embezzlement, theft, forgery, bribery, falsification or destruction of records; making false statements; or receiving stolen property;

c. Are not presently indicted for or otherwise criminally or civilly charged by a governmental entity (Federal, State or local) with commission of any of the offenses enumerated in paragraph b. of this certification; and

d. Have not within a three-year period preceding this proposal had one or more public transactions (Federal, State or local) terminated for cause or default.

e. Will submit a revised Debarment Certification immediately if his status changes and will show in his bid proposal an explanation for the change in status.

If the prequalified bidder cannot certify that he is not debarred, he shall provide an explanation with this submittal. An explanation will not necessarily result in denial of participation in a contract.

Failure to submit a non-collusion and debarment certification will result in the prequalified bidder's bid being considered non-responsive.

EXPLANATION:

=====

Award Limits on Multiple Projects

By answering YES to this statement, the bidder acknowledges that they are using the award limits on multiple projects? **Yes** **No**

A bidder who desires to bid on more than one project on which bids are to be opened on the same date, and who also desires to avoid receiving an award of more projects than he is equipped to handle, may bid on any number of projects but may limit the total amount of work awarded to him on selected projects by completing the AWARD LIMITS ON MULTIPLE PROJECTS.

The Award Limits on Multiple Projects must be filled in on each project bid for which the Bidder desires protection.

It is the desire of the Bidder to be awarded contracts, the value of which will not exceed a total of for those

projects indicated herein, for which bids will be opened on (MM/DD/YY)

The Award Limits shall apply to the following projects:

Contract Number
County

Contract Number
County

Contract Number
County

Contract Number
County

Contract Number
County

Contract Number
County

It is agreed that if I am (we are) the low Bidder(s) on indicated projects, the total value of which is more than the above stipulated award limits, the Board of Transportation will award me (us) projects from among those indicated

that have a total value not to exceed the award limit and will result in the lowest total bids to the Department of Transportation.

DBE List Summary

Project: STATE FUNDED
Bid Total: 15,346,704.64
Goal: 13.00% (1,995,071.60)
Total Entered: 13.00% (1,995,503.09)

Bidder ID: 15979
Business Name: BridgePoint Civil, LLC

ID	Name	Is Supplier?	Item Count	Amount	Is Complete?
11328	DAVID CHARLES LINCOLN DBA D&A LINCOLNS TRUCKING	False	10	231,648.00	True
11110	J M COLLINS HAULING LLC	False	3	49,999.00	True
11572	CRUZ BROTHERS CONCRETE, INC.	False	10	1,177,341.00	True
12802	NICKELSTON INDUSTRIES INC	False	5	14,853.00	True
2976	CAROLINA ENVIRONMENTAL CONTRACTING INC	False	2	62,670.00	True
11766	EASTERN EARTHSCAPES & CONSTRUCTION	False	12	243,581.00	True
11106	J & N HAULING LLC	False	3	30,000.00	True
4948	BURTCH TRUCKING CO.	False	4	29,196.00	True
101179	NPS Solutions	False	21	156,215.09	True

Name: DAVID CHARLES LINCOLN DBA D&A LINCOLNS TRUCKING ID: 11328

Address: P.O. BOX 48416 , CUMBERLAND, NC 28331

Used As: SubContractor DBE Items Total:\$231,648.00

Items for DAVID CHARLES LINCOLN DBA D&A LINCOLNS TRUCKING

0001 ROADWAY ITEMS				
0008	0106000000-E	42000.000	CY	\$4.0000 \$168,000.00
	BORROW EXCAVATION			
0013	0195000000-E	1000.000	CY	\$5.0000 \$5,000.00
	SELECT GRANULAR MATERIAL			
0016	0255000000-E	300.000	TON	\$10.0000 \$3,000.00
	GENERIC GRADING ITEM HAULING AND DISPOSAL OF PETROLEUM CONTAMINATED SOIL			
0017	0318000000-E	2200.000	TON	\$4.7500 \$10,450.00
	FOUNDATION CONDITIONING MATE- RIAL, MINOR STRUCTURES			
0038	1099700000-E	1000.000	TON	\$4.7500 \$4,750.00
	CLASS IV SUBGRADE STABILIZA- TION			
0039	1121000000-E	2633.000	TON	\$4.7500 \$12,506.75
	AGGREGATE BASE COURSE			
0040	1220000000-E	800.000	TON	\$4.7500 \$3,800.00
	INCIDENTAL STONE BASE			
0190	6006000000-E	585.000	TON	\$6.7500 \$3,948.75
	STONE FOR EROSION CONTROL, CLASS A			
0191	6009000000-E	1205.000	TON	\$7.7500 \$9,338.75
	STONE FOR EROSION CONTROL, CLASS B			
0192	6012000000-E	2285.000	TON	\$4.7500 \$10,853.75
	SEDIMENT CONTROL STONE			
Section 0001 Total				\$231,648.00
Item Total				\$231,648.00

Name: J M COLLINS HAULING LLC ID: 11110

Address: 151 NEW CREECH RD , SELMA, NC 27576

Used As: SubContractor DBE Items Total:\$49,999.00

Items for J M COLLINS HAULING LLC

0001	ROADWAY ITEMS			
0043	1491000000-E	3228 TON	\$6.0000	\$19,368.00
	ASPHALT CONC BASE COURSE, TYPE B25.0C			
0044	1503000000-E	2758.167 TON	\$6.0000	\$16,549.00
	ASPHALT CONC INTERMEDIATE COURSE, TYPE I19.0C			
0045	1519000000-E	2347 TON	\$6.0000	\$14,082.00
	ASPHALT CONC SURFACE COURSE, TYPE S9.5B			
Section 0001 Total				\$49,999.00
Item Total				\$49,999.00

Name: CRUZ BROTHERS CONCRETE, INC. ID: 11572

Address: 1572 PAYNE ROAD/LOT 75 LOT 75 , GRAHAM, NC 27253

Used As: SubContractor DBE Items Total:\$1,177,341.00

Items for CRUZ BROTHERS CONCRETE, INC.

0001 ROADWAY ITEMS				
0065	2440000000-N	13.000 EA	\$850.0000	\$11,050.00
	CONCRETE TRANSITIONAL SECTION FOR CATCH BASIN			
0066	2451000000-N	13.000 EA	\$850.0000	\$11,050.00
	CONCRETE TRANSITIONAL SECTION FOR DROP INLET			
0067	2535000000-E	240.000 LF	\$25.0000	\$6,000.00
	**"X **" CONCRETE CURB (8" X 18")			
0068	2538000000-E	5470.000 LF	\$23.0000	\$125,810.00
	'-" CONCRETE CURB & GUTTER (2'-9")			
0069	2549000000-E	16910.000 LF	\$22.4000	\$378,784.00
	2'-6" CONCRETE CURB & GUTTER			
0070	2591000000-E	4220.000 SY	\$42.3500	\$178,717.00
	4" CONCRETE SIDEWALK			
0071	2605000000-N	120.000 EA	\$1,900.0000	\$228,000.00
	CONCRETE CURB RAMPS			
0072	2612000000-E	840.000 SY	\$80.0000	\$67,200.00
	6" CONCRETE DRIVEWAY			
0073	2619000000-E	31.000 SY	\$105.0000	\$3,255.00
	4" CONCRETE PAVED DITCH			
0074	2655000000-E	2750.000 SY	\$60.9000	\$167,475.00
	5" MONOLITHIC CONCRETE ISLANDS (KEYED IN)			
Section 0001 Total				\$1,177,341.00
Item Total				\$1,177,341.00

Name: NICKELSTON INDUSTRIES INC ID: 12802

Address: POST OFFICE BOX 133 , LAWSONVILLE, NC 27022

Used As: SubContractor DBE Items Total:\$14,853.00

Items for NICKELSTON INDUSTRIES INC

0001	ROADWAY ITEMS				
0077	3030000000-E	475.000	LF	\$15.0000	\$7,125.00
	STEEL BEAM GUARDRAIL				
0078	3150000000-N	5.000	EA	\$30.0000	\$150.00
	ADDITIONAL GUARDRAIL POSTS				
0079	3210000000-N	2.000	EA	\$574.0000	\$1,148.00
	GUARDRAIL END UNITS, TYPE CAT-1				
0080	3287000000-N	2.000	EA	\$2,900.0000	\$5,800.00
	GUARDRAIL END UNITS, TYPE TL-3				
0081	3360000000-E	630.000	LF	\$1.0000	\$630.00
	REMOVE EXISTING GUARDRAIL				
Section 0001 Total					\$14,853.00
Item Total					\$14,853.00

Name: CAROLINA ENVIRONMENTAL CONTRACTING INC ID: 2976

Address: POST OFFICE BOX 1905 , MT. AIRY, NC 27030

Used As: SubContractor DBE Items Total:\$62,670.00

Items for CAROLINA ENVIRONMENTAL CONTRACTING INC

0001					
ROADWAY ITEMS					
0189	6000000000-E	20690.000 LF	\$3.0000	\$62,070.00	
	TEMPORARY SILT FENCE				
0197	6029000000-E	200.000 LF	\$3.0000	\$600.00	
	SAFETY FENCE				
Section 0001 Total				\$62,670.00	
Item Total				\$62,670.00	

Name: EASTERN EARTHSCAPES & CONSTRUCTION ID: 11766

Address: 3109 NC HWY 222 EAST , STANTONSBURG, NC 27883

Used As: SubContractor DBE Items Total:\$243,581.00

Items for EASTERN EARTHSCAPES & CONSTRUCTION

0001 ROADWAY ITEMS					
0193	6015000000-E	25.000	ACR	\$2,270.0000	\$56,750.00
	TEMPORARY MULCHING				
0194	6018000000-E	1600.000	LB	\$8.0000	\$12,800.00
	SEED FOR TEMPORARY SEEDING				
0195	6021000000-E	9.000	TON	\$375.0000	\$3,375.00
	FERTILIZER FOR TEMPORARY SEED-ING				
0210	6084000000-E	27.000	ACR	\$4,500.0000	\$121,500.00
	SEEDING & MULCHING				
0211	6087000000-E	15.000	ACR	\$200.0000	\$3,000.00
	MOWING				
0212	6090000000-E	300.000	LB	\$8.0000	\$2,400.00
	SEED FOR REPAIR SEEDING				
0213	6093000000-E	0.750	TON	\$474.6700	\$356.00
	FERTILIZER FOR REPAIR SEEDING				
0214	6096000000-E	600.000	LB	\$4.0000	\$2,400.00
	SEED FOR SUPPLEMENTAL SEEDING				
0215	6108000000-E	18.000	TON	\$475.0000	\$8,550.00
	FERTILIZER TOPDRESSING				
0217	6114500000-N	10.000	MHR	\$45.0000	\$450.00
	SPECIALIZED HAND MOWING				
0218	6117000000-N	25.000	EA	\$1,200.0000	\$30,000.00
	RESPONSE FOR EROSION CONTROL				
0220	6123000000-E	0.250	ACR	\$8,000.0000	\$2,000.00
	REFORESTATION				
Section 0001 Total					\$243,581.00
Item Total					\$243,581.00

Name: J & N HAULING LLC ID: 11106

Address: 109 MAY DR , SMITHFIELD, NC 27577

Used As: SubContractor DBE Items Total:\$30,000.00

Items for J & N HAULING LLC

0001	ROADWAY ITEMS			
0043	1491000000-E	1937 TON	\$6.0000	\$11,622.00
	ASPHALT CONC BASE COURSE, TYPE B25.0C			
0044	1503000000-E	1655 TON	\$6.0000	\$9,930.00
	ASPHALT CONC INTERMEDIATE COURSE, TYPE I19.0C			
0045	1519000000-E	1408 TON	\$6.0000	\$8,448.00
	ASPHALT CONC SURFACE COURSE, TYPE S9.5B			
Section 0001 Total				\$30,000.00
Item Total				\$30,000.00

Name: BURTCH TRUCKING CO. ID: 4948

Address: 605 INDIAN CAMP RD. , SMITHFIELD, NC 27577

Used As: SubContractor DBE Items Total:\$29,196.00

Items for BURTCH TRUCKING CO.

0001	ROADWAY ITEMS			
0043	1491000000-E	1291 TON	\$6.0000	\$7,746.00
	ASPHALT CONC BASE COURSE, TYPE B25.0C			
0044	1503000000-E	1103 TON	\$6.0000	\$6,618.00
	ASPHALT CONC INTERMEDIATE COURSE, TYPE I19.0C			
0045	1519000000-E	939 TON	\$6.0000	\$5,634.00
	ASPHALT CONC SURFACE COURSE, TYPE S9.5B			
0047	1693000000-E	1533 TON	\$6.0000	\$9,198.00
	ASPHALT PLANT MIX, PAVEMENT REPAIR			
Section 0001 Total				\$29,196.00
Item Total				\$29,196.00

Name: NPS Solutions ID: 101179

Address: PO Box 58344 Raleigh, NC 27658

Used As: SubContractor DBE Items Total:\$156,215.09

Items for NPS Solutions

0001 ROADWAY ITEMS					
0112	4650000000-N	619.000	EA	\$3.0000	\$1,857.00
	TEMPORARY RAISED PAVEMENT MARKERS				
0113	4685000000-E	32582.000	LF	\$0.9500	\$30,952.90
	THERMOPLASTIC PAVEMENT MARKING LINES (4", 90 MILS)				
0114	4688000000-E	201.000	LF	\$1.2000	\$241.20
	THERMOPLASTIC PAVEMENT MARKING LINES (6", 90 MILS)				
0115	4695000000-E	3713.000	LF	\$1.5000	\$5,569.50
	THERMOPLASTIC PAVEMENT MARKING LINES (8", 90 MILS)				
0116	4700000000-E	39.000	LF	\$1.7500	\$68.25
	THERMOPLASTIC PAVEMENT MARKING LINES (12", 90 MILS)				
0117	4720000000-E	10.000	EA	\$175.0000	\$1,750.00
	THERMOPLASTIC PAVEMENT MARKING CHARACTER (90 MILS)				
0118	4725000000-E	122.000	EA	\$95.0000	\$11,590.00
	THERMOPLASTIC PAVEMENT MARKING SYMBOL (90 MILS)				
0119	4810000000-E	134080.000	LF	\$0.2200	\$29,497.60
	PAINT PAVEMENT MARKING LINES (4")				
0120	4820000000-E	3358.000	LF	\$0.5200	\$1,746.16
	PAINT PAVEMENT MARKING LINES (8")				
0121	4825000000-E	1462.000	LF	\$0.6000	\$877.20
	PAINT PAVEMENT MARKING LINES (12")				
0122	4835000000-E	1808.000	LF	\$3.0000	\$5,424.00
	PAINT PAVEMENT MARKING LINES (24")				
0123	4840000000-N	40.000	EA	\$35.0000	\$1,400.00
	PAINT PAVEMENT MARKING CHARACTER				
0124	4845000000-N	232.000	EA	\$35.0000	\$8,120.00
	PAINT PAVEMENT MARKING SYMBOL				
0125	4850000000-E	35322.000	LF	\$0.7400	\$26,138.28
	REMOVAL OF PAVEMENT MARKING LINES (4")				
0126	4860000000-E	410.000	LF	\$1.6500	\$676.50
	REMOVAL OF PAVEMENT MARKING LINES (8")				
0127	4865000000-E	367.000	LF	\$2.0000	\$734.00
	REMOVAL OF PAVEMENT MARKING LINES (12")				
0128	4870000000-E	555.000	LF	\$5.5000	\$3,052.50
	REMOVAL OF PAVEMENT MARKING LINES (24")				
0129	4875000000-N	66.000	EA	\$90.0000	\$5,940.00
	REMOVAL OF PAVEMENT MARKING SYMBOLS & CHARACTERS				

0130	4891000000-E	45.000	LF	\$4.5000	\$202.50
	GENERIC PAVEMENT MARKING ITEM THERMOPLASTIC PAVEMENT MARKING LINES (16", 90 MILS)				
0131	4891000000-E	706.000	LF	\$9.7500	\$6,883.50
	GENERIC PAVEMENT MARKING ITEM THERMOPLASTIC PAVEMENT MARKING LINES (24", 90 MILS)				
0132	4895000000-N	519.000	EA	\$26.0000	\$13,494.00
	GENERIC PAVEMENT MARKING ITEM NON-CAST IRON SNOWFLOWABLE PAVEMENT MARKERS				
Section 0001 Total					\$156,215.09
Item Total					\$156,215.09

THIS PROPOSAL CONTAINS THE FOLLOWING ERRORS/WARNINGS (IF ANY)

This Bid contains 0 amendment files

Electronic Bid Submission

By submitting this bid electronically, I hereby acknowledge that all requirements included in the hard copy proposal, addendum, amendments, plans, standard specifications, supplemental specifications and special provisions are part of the bid and contract. Further, I acknowledge that I have read, understand, accept, acknowledge and agree to comply with all statements in this electronic bid.

I hereby certify that I have the authority to submit this bid.

Signature _____

Agency _____

Date _____

Signature _____

Agency _____

Date _____

Signature _____

Agency _____

Date _____

Contract Item Sheets For C204131

Line #	ItemNumber	Sec #	Description	Quantity Unit	Unit Bid Price	Amount Bid
ROADWAY ITEMS						
0001	0000100000-N	800	MOBILIZATION	Lump Sum LS	690,000.00	690,000.00
0002	0000400000-N	801	CONSTRUCTION SURVEYING	Lump Sum LS	117,037.00	117,037.00
0003	0000915000-N	SP	GENERIC MISCELLANEOUS ITEM REMOVE WOOD POLE	127 EA	115.00	14,605.00
0004	0001000000-E	200	CLEARING & GRUBBING .. ACRE(S)	Lump Sum LS	510,000.00	510,000.00
0005	0008000000-E	200	SUPPLEMENTARY CLEARING & GRUB- BING	1 ACR	22,722.00	22,722.00
0006	0022000000-E	225	UNCLASSIFIED EXCAVATION	5,000 CY	18.00	90,000.00
0007	0036000000-E	225	UNDERCUT EXCAVATION	1,000 CY	35.00	35,000.00
0008	0106000000-E	230	BORROW EXCAVATION	42,000 CY	5.00	210,000.00
0009	0134000000-E	240	DRAINAGE DITCH EXCAVATION	1,240 CY	8.00	9,920.00
0010	0156000000-E	250	REMOVAL OF EXISTING ASPHALT PAVEMENT	21,010 SY	5.00	105,050.00
0011	0163000000-E	250	REMOVAL OF EXISTING CONCRETE PAVEMENT	1,000 SY	84.00	84,000.00
0012	0177000000-E	250	BREAKING OF EXISTING ASPHALT PAVEMENT	720 SY	21.00	15,120.00
0013	0195000000-E	265	SELECT GRANULAR MATERIAL	1,000 CY	14.00	14,000.00
0014	0196000000-E	270	GEOTEXTILE FOR SOIL STABILIZA- TION	1,700 SY	5.00	8,500.00
0015	0199000000-E	SP	TEMPORARY SHORING	410 SF	41.00	16,810.00
0016	0255000000-E	SP	GENERIC GRADING ITEM HAULING AND DISPOSAL OF PETROLEUM CONTAMINATED SOIL	300 TON	69.00	20,700.00
0017	0318000000-E	300	FOUNDATION CONDITIONING MATE- RIAL, MINOR STRUCTURES	2,200 TON	36.00	79,200.00
0018	0320000000-E	300	FOUNDATION CONDITIONING GEO- TEXTILE	6,400 SY	5.00	32,000.00

Line #	ItemNumber	Sec #	Description	Quantity Unit	Unit Bid Price	Amount Bid
0019	0335500000-E	305	30" DRAINAGE PIPE	24 LF	82.00	1,968.00
0020	0335850000-E	305	*** DRAINAGE PIPE ELBOWS (30")	2 EA	400.00	800.00
0021	0366000000-E	310	15" RC PIPE CULVERTS, CLASS III	692 LF	33.00	22,836.00
0022	0372000000-E	310	18" RC PIPE CULVERTS, CLASS III	1,128 LF	41.00	46,248.00
0023	0378000000-E	310	24" RC PIPE CULVERTS, CLASS III	300 LF	56.00	16,800.00
0024	0384000000-E	310	30" RC PIPE CULVERTS, CLASS III	412 LF	73.00	30,076.00
0025	0390000000-E	310	36" RC PIPE CULVERTS, CLASS III	232 LF	104.00	24,128.00
0026	0396000000-E	310	42" RC PIPE CULVERTS, CLASS III	56 LF	154.00	8,624.00
0027	0448000000-E	310	***** RC PIPE CULVERTS, CLASS IV (12")	108 LF	40.00	4,320.00
0028	0448200000-E	310	15" RC PIPE CULVERTS, CLASS IV	324 LF	41.00	13,284.00
0029	0448300000-E	310	18" RC PIPE CULVERTS, CLASS IV	7,300 LF	45.00	328,500.00
0030	0448400000-E	310	24" RC PIPE CULVERTS, CLASS IV	640 LF	69.00	44,160.00
0031	0448500000-E	310	30" RC PIPE CULVERTS, CLASS IV	268 LF	100.00	26,800.00
0032	0448600000-E	310	36" RC PIPE CULVERTS, CLASS IV	1,168 LF	138.00	161,184.00
0033	0448700000-E	310	42" RC PIPE CULVERTS, CLASS IV	548 LF	203.00	111,244.00
0034	0995000000-E	340	PIPE REMOVAL	4,392 LF	16.00	70,272.00
0035	0996000000-N	350	PIPE CLEAN OUT	1 EA	1,500.00	1,500.00
0036	1011000000-N	500	FINE GRADING	Lump Sum LS	942,419.00	942,419.00
0037	1099500000-E	505	SHALLOW UNDERCUT	500 CY	18.00	9,000.00

Line #	ItemNumber	Sec #	Description	Quantity Unit	Unit Bid Price	Amount Bid
0038	1099700000-E	505	CLASS IV SUBGRADE STABILIZATION	1,000 TON	24.00	24,000.00
0039	1121000000-E	520	AGGREGATE BASE COURSE	2,633 TON	23.00	60,559.00
0040	1220000000-E	545	INCIDENTAL STONE BASE	800 TON	39.00	31,200.00
0041	1297000000-E	607	MILLING ASPHALT PAVEMENT, **** DEPTH (1-1/2")	5,350 SY	8.00	42,800.00
0042	1330000000-E	607	INCIDENTAL MILLING	2,060 SY	10.00	20,600.00
0043	1491000000-E	610	ASPHALT CONC BASE COURSE, TYPE B25.0C	19,850 TON	64.00	1,270,400.00
0044	1503000000-E	610	ASPHALT CONC INTERMEDIATE COURSE, TYPE I19.0C	16,960 TON	65.00	1,102,400.00
0045	1519000000-E	610	ASPHALT CONC SURFACE COURSE, TYPE S9.5B	14,430 TON	66.00	952,380.00
0046	1575000000-E	620	ASPHALT BINDER FOR PLANT MIX	2,675 TON	450.00	1,203,750.00
0047	1693000000-E	654	ASPHALT PLANT MIX, PAVEMENT REPAIR	1,840 TON	172.00	316,480.00
0048	1704000000-E	SP	PATCHING EXISTING PAVEMENT	335 TON	143.00	47,905.00
0049	2022000000-E	815	SUBDRAIN EXCAVATION	896 CY	22.00	19,712.00
0050	2033000000-E	815	SUBDRAIN FINE AGGREGATE	672 CY	68.00	45,696.00
0051	2044000000-E	815	6" PERFORATED SUBDRAIN PIPE	4,000 LF	16.00	64,000.00
0052	2070000000-N	815	SUBDRAIN PIPE OUTLET	8 EA	448.00	3,584.00
0053	2077000000-E	815	6" OUTLET PIPE	48 LF	56.00	2,688.00
0054	2209000000-E	838	ENDWALLS	3.4 CY	1,800.00	6,120.00
0055	2264000000-E	840	PIPE PLUGS	3.1 CY	1,900.00	5,890.00
0056	2275000000-E	SP	FLOWABLE FILL	11 CY	287.00	3,157.00

Line #	ItemNumber	Sec #	Description	Quantity Unit	Unit Bid Price	Amount Bid
0057	2286000000-N	840	MASONRY DRAINAGE STRUCTURES	182 EA	1,600.00	291,200.00
0058	2308000000-E	840	MASONRY DRAINAGE STRUCTURES	63.4 LF	370.00	23,458.00
0059	2364000000-N	840	FRAME WITH TWO GRATES, STD 840.16	36 EA	670.00	24,120.00
0060	2366000000-N	840	FRAME WITH TWO GRATES, STD 840.24	1 EA	884.00	884.00
0061	2374000000-N	840	FRAME WITH GRATE & HOOD, STD 840.03, TYPE ** (E)	27 EA	884.00	23,868.00
0062	2374000000-N	840	FRAME WITH GRATE & HOOD, STD 840.03, TYPE ** (F)	51 EA	958.00	48,858.00
0063	2374000000-N	840	FRAME WITH GRATE & HOOD, STD 840.03, TYPE ** (G)	55 EA	964.00	53,020.00
0064	2396000000-N	840	FRAME WITH COVER, STD 840.54	11 EA	671.00	7,381.00
0065	2440000000-N	852	CONCRETE TRANSITIONAL SECTION FOR CATCH BASIN	13 EA	1,700.00	22,100.00
0066	2451000000-N	852	CONCRETE TRANSITIONAL SECTION FOR DROP INLET	13 EA	1,700.00	22,100.00
0067	2535000000-E	846	***X*** CONCRETE CURB (8" X 18")	240 LF	28.00	6,720.00
0068	2538000000-E	846	**1,*** CONCRETE CURB & GUTTER (2'-9")	5,470 LF	27.00	147,690.00
0069	2549000000-E	846	2'-6" CONCRETE CURB & GUTTER	16,910 LF	25.00	422,750.00
0070	2591000000-E	848	4" CONCRETE SIDEWALK	4,220 SY	49.00	206,780.00
0071	2605000000-N	848	CONCRETE CURB RAMPS	120 EA	2,181.00	261,720.00
0072	2612000000-E	848	6" CONCRETE DRIVEWAY	840 SY	92.00	77,280.00
0073	2619000000-E	850	4" CONCRETE PAVED DITCH	31 SY	120.00	3,720.00

Contract Item Sheets For C204131

Line #	ItemNumber	Sec #	Description	Quantity Unit	Unit Bid Price	Amount Bid
0074	2655000000-E	852	5" MONOLITHIC CONCRETE ISLANDS (KEYED IN)	2,750 SY	69.00	189,750.00
0075	2815000000-N	858	ADJUSTMENT OF DROP INLETS	1 EA	721.00	721.00
0076	2830000000-N	858	ADJUSTMENT OF MANHOLES	1 EA	1,472.00	1,472.00
0077	3030000000-E	862	STEEL BEAM GUARDRAIL	475 LF	16.00	7,600.00
0078	3150000000-N	862	ADDITIONAL GUARDRAIL POSTS	5 EA	34.00	170.00
0079	3210000000-N	862	GUARDRAIL END UNITS, TYPE CAT-1	2 EA	574.00	1,148.00
0080	3287000000-N	SP	GUARDRAIL END UNITS, TYPE TL-3	2 EA	3,043.00	6,086.00
0081	3360000000-E	863	REMOVE EXISTING GUARDRAIL	630 LF	1.00	630.00
0082	3628000000-E	876	RIP RAP, CLASS I	45 TON	37.00	1,665.00
0083	3649000000-E	876	RIP RAP, CLASS B	75 TON	38.00	2,850.00
0084	3656000000-E	876	GEOTEXTILE FOR DRAINAGE	975 SY	6.00	5,850.00
0085	4025000000-E	901	CONTRACTOR FURNISHED, TYPE *** SIGN (A)	38 SF	7.00	266.00
0086	4025000000-E	901	CONTRACTOR FURNISHED, TYPE *** SIGN (B)	30 SF	8.00	240.00
0087	4025000000-E	901	CONTRACTOR FURNISHED, TYPE *** SIGN (D)	143 SF	12.00	1,716.00
0088	4025000000-E	901	CONTRACTOR FURNISHED, TYPE *** SIGN (E)	755 SF	18.00	13,590.00
0089	4025000000-E	901	CONTRACTOR FURNISHED, TYPE *** SIGN (F)	384 SF	26.00	9,984.00
0090	4054000000-E	902	PLAIN CONCRETE SIGN FOUNDA- TIONS	1 CY	370.00	370.00

Line #	ItemNumber	Sec #	Description	Quantity Unit	Unit Bid Price	Amount Bid
0091	4060000000-E	903	SUPPORTS, BREAKAWAY STEEL BEAM	225 LB	5.00	1,125.00
0092	4072000000-E	903	SUPPORTS, 3-LB STEEL U-CHANNEL	2,700 LF	8.00	21,600.00
0093	4096000000-N	904	SIGN ERECTION, TYPE D	10 EA	115.00	1,150.00
0094	4102000000-N	904	SIGN ERECTION, TYPE E	121 EA	52.00	6,292.00
0095	4108000000-N	904	SIGN ERECTION, TYPE F	27 EA	103.00	2,781.00
0096	4110000000-N	904	SIGN ERECTION, TYPE *** (GROUND MOUNTED) (A)	1 EA	1,723.00	1,723.00
0097	4110000000-N	904	SIGN ERECTION, TYPE *** (GROUND MOUNTED) (B)	1 EA	2,010.00	2,010.00
0098	4152000000-N	907	DISPOSAL OF SIGN SYSTEM, STEEL BEAM	1 EA	919.00	919.00
0099	4158000000-N	907	DISPOSAL OF SIGN SYSTEM, WOOD	100 EA	29.00	2,900.00
0100	4400000000-E	1110	WORK ZONE SIGNS (STATIONARY)	691 SF	7.00	4,837.00
0101	4405000000-E	1110	WORK ZONE SIGNS (PORTABLE)	197 SF	10.00	1,970.00
0102	4410000000-E	1110	WORK ZONE SIGNS (BARRICADE MOUNTED)	184 SF	7.00	1,288.00
0103	4415000000-N	1115	FLASHING ARROW BOARD	3 EA	3,674.00	11,022.00
0104	4420000000-N	1120	PORTABLE CHANGEABLE MESSAGE SIGN	4 EA	9,646.00	38,584.00
0105	4430000000-N	1130	DRUMS	651 EA	44.00	28,644.00
0106	4445000000-E	1145	BARRICADES (TYPE III)	128 LF	29.00	3,712.00
0107	4447000000-E	SP	PEDESTRIAN CHANNELIZING DEVICES	60 LF	34.00	2,040.00
0108	4455000000-N	1150	FLAGGER	20 DAY	1,378.00	27,560.00
0109	4480000000-N	1165	TMA	4 EA	13,780.00	55,120.00

Line #	ItemNumber	Sec #	Description	Quantity Unit	Unit Bid Price	Amount Bid
0110	4507000000-E	1170	WATER FILLED BARRIER	500 LF	84.00	42,000.00
0111	4510000000-N	1190	LAW ENFORCEMENT	104 HR	63.00	6,552.00
0112	4650000000-N	1251	TEMPORARY RAISED PAVEMENT MARKERS	619 EA	5.00	3,095.00
0113	4685000000-E	1205	THERMOPLASTIC PAVEMENT MARKING LINES (4", 90 MILS)	32,582 LF	1.00	32,582.00
0114	4688000000-E	1205	THERMOPLASTIC PAVEMENT MARKING LINES (6", 90 MILS)	201 LF	1.20	241.20
0115	4695000000-E	1205	THERMOPLASTIC PAVEMENT MARKING LINES (8", 90 MILS)	3,713 LF	2.00	7,426.00
0116	4700000000-E	1205	THERMOPLASTIC PAVEMENT MARKING LINES (12", 90 MILS)	39 LF	2.00	78.00
0117	4720000000-E	1205	THERMOPLASTIC PAVEMENT MARKING CHARACTER (90 MILS)	10 EA	175.00	1,750.00
0118	4725000000-E	1205	THERMOPLASTIC PAVEMENT MARKING SYMBOL (90 MILS)	122 EA	109.00	13,298.00
0119	4810000000-E	1205	PAINT PAVEMENT MARKING LINES (4")	134,080 LF	0.25	33,520.00
0120	4820000000-E	1205	PAINT PAVEMENT MARKING LINES (8")	3,358 LF	0.52	1,746.16
0121	4825000000-E	1205	PAINT PAVEMENT MARKING LINES (12")	1,462 LF	1.00	1,462.00
0122	4835000000-E	1205	PAINT PAVEMENT MARKING LINES (24")	1,808 LF	3.00	5,424.00
0123	4840000000-N	1205	PAINT PAVEMENT MARKING CHARACTER	40 EA	37.00	1,480.00
0124	4845000000-N	1205	PAINT PAVEMENT MARKING SYMBOL	232 EA	37.00	8,584.00
0125	4850000000-E	1205	REMOVAL OF PAVEMENT MARKING LINES (4")	35,322 LF	0.74	26,138.28
0126	4860000000-E	1205	REMOVAL OF PAVEMENT MARKING LINES (8")	410 LF	1.65	676.50

Contract Item Sheets For C204131

Line #	ItemNumber	Sec #	Description	Quantity Unit	Unit Bid Price	Amount Bid
0127	4865000000-E	1205	REMOVAL OF PAVEMENT MARKING LINES (12")	367 LF	2.00	734.00
0128	4870000000-E	1205	REMOVAL OF PAVEMENT MARKING LINES (24")	555 LF	5.50	3,052.50
0129	4875000000-N	1205	REMOVAL OF PAVEMENT MARKING SYMBOLS & CHARACTERS	66 EA	90.00	5,940.00
0130	4891000000-E	1205	GENERIC PAVEMENT MARKING ITEM THERMOPLASTIC PAVEMENT MARKING LINES (16", 90 MILS)	45 LF	5.00	225.00
0131	4891000000-E	1205	GENERIC PAVEMENT MARKING ITEM THERMOPLASTIC PAVEMENT MARKING LINES (24", 90 MILS)	706 LF	11.00	7,766.00
0132	4895000000-N	SP	GENERIC PAVEMENT MARKING ITEM NON-CAST IRON SNOWPLOWABLE PAVEMENT MARKERS	519 EA	30.00	15,570.00
0133	5325200000-E	1510	2" WATER LINE	109 LF	38.00	4,142.00
0134	5325300000-E	1510	3" WATER LINE	6 LF	192.00	1,152.00
0135	5325600000-E	1510	6" WATER LINE	718 LF	32.00	22,976.00
0136	5325800000-E	1510	8" WATER LINE	745 LF	47.00	35,015.00
0137	5326000000-E	1510	10" WATER LINE	8,099 LF	61.00	494,039.00
0138	5326200000-E	1510	12" WATER LINE	375 LF	74.00	27,750.00
0139	5326600000-E	1510	16" WATER LINE	20 LF	222.00	4,440.00
0140	5327000000-E	1510	20" WATER LINE	712 LF	166.00	118,192.00
0141	5329000000-E	1510	DUCTILE IRON WATER PIPE FITTINGS	25,145 LB	9.00	226,305.00
0142	5534000000-E	1515	*** VALVE (3")	1 EA	1,430.00	1,430.00
0143	5536000000-E	1515	2" VALVE	2 EA	761.00	1,522.00
0144	5540000000-E	1515	6" VALVE	21 EA	1,477.00	31,017.00

Line #	ItemNumber	Sec #	Description	Quantity Unit	Unit Bid Price	Amount Bid
0145	5546000000-E	1515	8" VALVE	4 EA	1,689.00	6,756.00
0146	5552000000-E	1515	10" VALVE	20 EA	2,390.00	47,800.00
0147	5558000000-E	1515	12" VALVE	2 EA	2,861.00	5,722.00
0148	5558600000-E	1515	16" VALVE	1 EA	4,406.00	4,406.00
0149	5559000000-E	1515	20" VALVE	2 EA	6,451.00	12,902.00
0150	5606000000-E	1515	2" BLOW OFF	1 EA	1,668.00	1,668.00
0151	5648000000-N	1515	RELOCATE WATER METER	56 EA	1,209.00	67,704.00
0152	5649000000-N	1515	RECONNECT WATER METER	21 EA	549.00	11,529.00
0153	5656100000-E	1515	RELOCATE *** RPZ BACKFLOW PRE-VENTION ASSEMBLY (1")	17 EA	4,244.00	72,148.00
0154	5656100000-E	1515	RELOCATE *** RPZ BACKFLOW PRE-VENTION ASSEMBLY (2-1/2")	1 EA	6,941.00	6,941.00
0155	5656210000-E	1515	RELOCATE 2" RPZ BACKFLOW PRE-VENTION ASSEMBLY	2 EA	4,822.00	9,644.00
0156	5666000000-N	1515	FIRE HYDRANT	12 EA	4,713.00	56,556.00
0157	5673000000-E	1515	FIRE HYDRANT LEG	94 LF	70.00	6,580.00
0158	5685000000-E	1515	12" LINE STOP WITH BYPASS	4 EA	18,876.00	75,504.00
0159	5686000000-E	1515	*** WATER SERVICE LINE (2")	371 LF	37.00	13,727.00
0160	5686000000-E	1515	*** WATER SERVICE LINE (2-1/2")	27 LF	60.00	1,620.00
0161	5686500000-E	1515	WATER SERVICE LINE	3,807 LF	22.00	83,754.00
0162	5691300000-E	1520	8" SANITARY GRAVITY SEWER	393 LF	90.00	35,370.00
0163	5691500000-E	1520	12" SANITARY GRAVITY SEWER	125 LF	45.00	5,625.00

Line #	ItemNumber	Sec #	Description	Quantity Unit	Unit Bid Price	Amount Bid
0164	5709400000-E	1520	8" FORCE MAIN SEWER	44 LF	79.00	3,476.00
0165	5709600000-E	1520	12" FORCE MAIN SEWER	1,366 LF	77.00	105,182.00
0166	5768000000-N	1520	SANITARY SEWER CLEAN-OUT	40 EA	4,137.00	165,480.00
0167	5768500000-E	1520	SEWER SERVICE LINE	1,000 LF	71.00	71,000.00
0168	5769000000-E	1520	DUCTILE IRON SEWER PIPE FITTINGS	4,015 LB	15.00	60,225.00
0169	5775000000-E	1525	4' DIA UTILITY MANHOLE	8 EA	3,346.00	26,768.00
0170	5781000000-E	1525	UTILITY MANHOLE WALL 4' DIA	11 LF	202.00	2,222.00
0171	5800000000-E	1530	ABANDON 6" UTILITY PIPE	3,004 LF	7.00	21,028.00
0172	5801000000-E	1530	ABANDON 8" UTILITY PIPE	1,437 LF	9.00	12,933.00
0173	5802000000-E	1530	ABANDON 10" UTILITY PIPE	6,255 LF	12.00	75,060.00
0174	5804000000-E	1530	ABANDON 12" UTILITY PIPE	2,505 LF	18.00	45,090.00
0175	5810000000-E	1530	ABANDON 16" UTILITY PIPE	851 LF	34.00	28,934.00
0176	5815000000-N	1530	REMOVE WATER METER	18 EA	431.00	7,758.00
0177	5816000000-N	1530	ABANDON UTILITY MANHOLE	2 EA	2,908.00	5,816.00
0178	5835600000-E	1540	12" ENCASEMENT PIPE	194 LF	34.00	6,596.00
0179	5835700000-E	1540	16" ENCASEMENT PIPE	90 LF	57.00	5,130.00
0180	5835900000-E	1540	20" ENCASEMENT PIPE	494 LF	60.00	29,640.00
0181	5836000000-E	1540	24" ENCASEMENT PIPE	330 LF	83.00	27,390.00
0182	5872500000-E	1550	BORE AND JACK OF *** (12")	194 LF	143.00	27,742.00
0183	5872500000-E	1550	BORE AND JACK OF *** (16")	90 LF	143.00	12,870.00

Line #	ItemNumber	Sec #	Description	Quantity Unit	Unit Bid Price	Amount Bid
0184	5872500000-E	1550	BORE AND JACK OF *** (20")	494 LF	166.00	82,004.00
0185	5872500000-E	1550	BORE AND JACK OF *** (24")	330 LF	212.00	69,960.00
0186	5882000000-N	SP	GENERIC UTILITY ITEM 8" FLEXIBLE COUPLING	4 EA	100.00	400.00
0187	5882000000-N	SP	GENERIC UTILITY ITEM REMOVE AND STOCKPILE EXISTING FIRE HYDRANT	12 EA	421.00	5,052.00
0188	5882000000-N	SP	GENERIC UTILITY ITEM REMOVE BACKFLOW PREVENTION ASSEMBLY	3 EA	380.00	1,140.00
0189	6000000000-E	1605	TEMPORARY SILT FENCE	20,690 LF	3.00	62,070.00
0190	6006000000-E	1610	STONE FOR EROSION CONTROL, CLASS A	585 TON	39.00	22,815.00
0191	6009000000-E	1610	STONE FOR EROSION CONTROL, CLASS B	1,205 TON	40.00	48,200.00
0192	6012000000-E	1610	SEDIMENT CONTROL STONE	2,285 TON	27.00	61,695.00
0193	6015000000-E	1615	TEMPORARY MULCHING	25 ACR	2,270.00	56,750.00
0194	6018000000-E	1620	SEED FOR TEMPORARY SEEDING	1,600 LB	8.00	12,800.00
0195	6021000000-E	1620	FERTILIZER FOR TEMPORARY SEED- ING	9 TON	1,010.00	9,090.00
0196	6024000000-E	1622	TEMPORARY SLOPE DRAINS	485 LF	32.00	15,520.00
0197	6029000000-E	SP	SAFETY FENCE	200 LF	3.00	600.00
0198	6030000000-E	1630	SILT EXCAVATION	1,850 CY	9.00	16,650.00
0199	6036000000-E	1631	MATTING FOR EROSION CONTROL	8,590 SY	3.00	25,770.00
0200	6037000000-E	SP	COIR FIBER MAT	100 SY	6.00	600.00
0201	6042000000-E	1632	1/4" HARDWARE CLOTH	7,260 LF	5.00	36,300.00

Line #	ItemNumber	Sec #	Description	Quantity Unit	Unit Bid Price	Amount Bid
0202	6043000000-E	SP	LOW PERMEABILITY GEOTEXTILE	150 SY	7.00	1,050.00
0203	6045000000-E	SP	*** TEMPORARY PIPE (36")	60 LF	98.00	5,880.00
0204	6070000000-N	1639	SPECIAL STILLING BASINS	2 EA	634.00	1,268.00
0205	6071012000-E	SP	COIR FIBER WATTLE	860 LF	18.00	15,480.00
0206	6071020000-E	SP	POLYACRYLAMIDE (PAM)	200 LB	8.00	1,600.00
0207	6071030000-E	1640	COIR FIBER BAFFLE	660 LF	5.00	3,300.00
0208	6071050000-E	SP	*** SKIMMER (1-1/2")	3 EA	1,361.00	4,083.00
0209	6071050000-E	SP	*** SKIMMER (2")	1 EA	2,154.00	2,154.00
0210	6084000000-E	1660	SEEDING & MULCHING	27 ACR	4,500.00	121,500.00
0211	6087000000-E	1660	MOWING	15 ACR	200.00	3,000.00
0212	6090000000-E	1661	SEED FOR REPAIR SEEDING	300 LB	13.00	3,900.00
0213	6093000000-E	1661	FERTILIZER FOR REPAIR SEEDING	0.75 TON	1,100.00	825.00
0214	6096000000-E	1662	SEED FOR SUPPLEMENTAL SEEDING	600 LB	13.00	7,800.00
0215	6108000000-E	1665	FERTILIZER TOPDRESSING	18 TON	574.00	10,332.00
0216	6111000000-E	SP	IMPERVIOUS DIKE	46 LF	63.00	2,898.00
0217	6114500000-N	1667	SPECIALIZED HAND MOWING	10 MHR	115.00	1,150.00
0218	6117000000-N	SP	RESPONSE FOR EROSION CONTROL	25 EA	1,200.00	30,000.00
0219	6117500000-N	SP	CONCRETE WASHOUT STRUCTURE	4 EA	1,320.00	5,280.00
0220	6123000000-E	1670	REFORESTATION	0.25 ACR	8,000.00	2,000.00
0221	6132000000-N	SP	GENERIC EROSION CONTROL ITEM FABRIC INSERT INLET PROTECTION DEVICE	6 EA	375.00	2,250.00

Contract Item Sheets For C204131

Line #	ItemNumber	Sec #	Description	Quantity Unit	Unit Bid Price	Amount Bid
0222	6132000000-N	SP	GENERIC EROSION CONTROL ITEM FABRIC INSERT INLET PROTECTION DEVICE CLEANOUT	12 EA	280.00	3,360.00
0223	7000000000-E	1705	PEDESTRIAN SIGNAL HEAD (***, ** SECTION) (16", 1 SECTION WITH COUNT- DOWN)	22 EA	815.00	17,930.00
0224	7060000000-E	1705	SIGNAL CABLE	8,243 LF	4.00	32,972.00
0225	7120000000-E	1705	VEHICLE SIGNAL HEAD (12", 3 SECTION)	59 EA	804.00	47,436.00
0226	7132000000-E	1705	VEHICLE SIGNAL HEAD (12", 4 SECTION)	14 EA	947.00	13,258.00
0227	7144000000-E	1705	VEHICLE SIGNAL HEAD (12", 5 SECTION)	3 EA	1,177.00	3,531.00
0228	7252000000-E	1710	MESSENGER CABLE (1/4")	7,290 LF	2.00	14,580.00
0229	7264000000-E	1710	MESSENGER CABLE (3/8")	3,325 LF	4.00	13,300.00
0230	7300000000-E	1715	UNPAVED TRENCHING (*****) (1, 2")	1,175 LF	6.00	7,050.00
0231	7300000000-E	1715	UNPAVED TRENCHING (*****) (2, 2")	1,900 LF	8.00	15,200.00
0232	7301000000-E	1715	DIRECTIONAL DRILL (*****) (1, 2")	162 LF	21.00	3,402.00
0233	7324000000-N	1716	JUNCTION BOX (STANDARD SIZE)	23 EA	316.00	7,268.00
0234	7348000000-N	1716	JUNCTION BOX (OVER-SIZED, HEA- VY DUTY)	9 EA	574.00	5,166.00
0235	7360000000-N	1720	WOOD POLE	11 EA	917.00	10,087.00
0236	7372000000-N	1721	GUY ASSEMBLY	33 EA	287.00	9,471.00
0237	7408000000-E	1722	1" RISER WITH WEATHERHEAD	3 EA	1.00	3.00
0238	7420000000-E	1722	2" RISER WITH WEATHERHEAD	3 EA	345.00	1,035.00

Line #	ItemNumber	Sec #	Description	Quantity Unit	Unit Bid Price	Amount Bid
0239	7430000000-N	1722	HEAT SHRINK TUBING RETROFIT KIT	1 EA	143.00	143.00
0240	7432000000-E	1722	2" RISER WITH HEAT SHRINK TUBING	5 EA	545.00	2,725.00
0241	7444000000-E	1725	INDUCTIVE LOOP SAWCUT	3,482 LF	6.00	20,892.00
0242	7456000000-E	1726	LEAD-IN CABLE (*****) (14-2)	16,592 LF	1.00	16,592.00
0243	7516000000-E	1730	COMMUNICATIONS CABLE (**FIBER) (24)	9,380 LF	2.00	18,760.00
0244	7540000000-N	1731	SPLICE ENCLOSURE	4 EA	2,067.00	8,268.00
0245	7541000000-N	1731	MODIFY SPLICE ENCLOSURE	2 EA	1,263.00	2,526.00
0246	7552000000-N	1731	INTERCONNECT CENTER	4 EA	1,866.00	7,464.00
0247	7576000000-N	SP	METAL STRAIN SIGNAL POLE	16 EA	11,483.00	183,728.00
0248	7613000000-N	SP	SOIL TEST	16 EA	1,033.00	16,528.00
0249	7614100000-E	SP	DRILLED PIER FOUNDATION	112 CY	833.00	93,296.00
0250	7636000000-N	1745	SIGN FOR SIGNALS	8 EA	488.00	3,904.00
0251	7642200000-N	1743	TYPE II PEDESTAL WITH FOUNDATION	22 EA	1,837.00	40,414.00
0252	7684000000-N	1750	SIGNAL CABINET FOUNDATION	4 EA	689.00	2,756.00
0253	7696000000-N	1751	CONTROLLERS WITH CABINET (*****) (2070E, BASE MOUNTED)	4 EA	17,225.00	68,900.00
0254	7744000000-N	1751	DETECTOR CARD (TYPE 170)	33 EA	132.00	4,356.00
0255	7901000000-N	1753	CABINET BASE EXTENDER	4 EA	344.00	1,376.00
0256	7980000000-N	SP	GENERIC SIGNAL ITEM MICROWAVE VEHICLE DETECTION SYSTEM - MULTIPLE ZONES	12 EA	9,184.00	110,208.00

Contract Item Sheets For C204131

Line #	ItemNumber	Sec #	Description	Quantity Unit	Unit Bid Price	Amount Bid
0257	8126000000-N	414	CULVERT EXCAVATION, STA ***** (75+49.09 -L-)	Lump Sum LS	13,751.00	13,751.00
0258	8133000000-E	414	FOUNDATION CONDITIONING MATERIAL, BOX CULVERT	21 TON	34.00	714.00
0259	8196000000-E	420	CLASS A CONCRETE (CULVERT)	33.2 CY	1,330.00	44,156.00
0260	8245000000-E	425	REINFORCING STEEL (CULVERT)	4,117 LB	2.00	8,234.00

TOTAL AMOUNT OF BID FOR ENTIRE PROJECT

\$15,346,704.64

0806/Apr09/Q600101.1/D1146453837000/E260

Contract No. C204131
County Wayne

Rev. 1-16-18

**EXECUTION OF CONTRACT
NON-COLLUSION, DEBARMENT AND GIFT BAN CERTIFICATION**

LIMITED LIABILITY COMPANY

The Contractor declares (or certifies, verifies, or states) under penalty of perjury under the laws of the United States that neither he, nor any official, agent or employee has entered into any agreement, participated in any collusion, or otherwise taken any action which is in restraint of free competitive bidding in connection with this Contract, that the Contractor has not been convicted of violating *N.C.G.S. § 133-24* within the last three years, and that the Contractor intends to do the work with its own bonafide employees or subcontractors and did not bid for the benefit of another contractor.

By submitting this Execution of Contract, Non-Collusion and Debarment Certification, the Contractor is certifying his status under penalty of perjury under the laws of the United States in accordance with the Debarment Certification attached, provided that the Debarment Certification also includes any required statements concerning exceptions that are applicable.

N.C.G.S. § 133-32 and Executive Order 24 prohibit the offer to, or acceptance by, any State Employee of any gift from anyone with a contract with the State, or from any person seeking to do business with the State. By execution of any response in this procurement, you attest, for your entire organization and its employees or agents, that you are not aware that any such gift has been offered, accepted, or promised by any employees of your organization.

SIGNATURE OF CONTRACTOR

BridgePoint Civil, LLC

Full Name of Firm

PO Box 729 Pikeville, NC 27863

Address as Prequalified

Signature of Witness

Patti King

Print or type Signer's name

Signature of Member/Manager/Authorized Agent
Select appropriate title

Jeremy Smith

Print or type Signer's Name

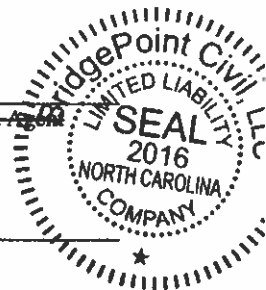

DEBARMENT CERTIFICATION**Conditions for certification:**

1. The prequalified bidder shall provide immediate written notice to the Department if at any time the bidder learns that his certification was erroneous when he submitted his debarment certification or explanation filed with the Department, or has become erroneous because of changed circumstances.
2. The terms *covered transaction, debarred, suspended, ineligible, lower tier covered transaction, participant, person, primary covered transaction, principal, proposal, and voluntarily excluded*, as used in this provision, have the meanings set out in the Definitions and Coverage sections of the rules implementing Executive Order 12549. A copy of the Federal Rules requiring this certification and detailing the definitions and coverages may be obtained from the Contract Officer of the Department.
3. The prequalified bidder agrees by submitting this form, that he will not knowingly enter into any lower tier covered transaction with a person who is debarred, suspended, declared ineligible, or voluntarily excluded from participation in NCDOT contracts, unless authorized by the Department.
4. For Federal Aid projects, the prequalified bidder further agrees that by submitting this form he will include the Federal-Aid Provision titled *Required Contract Provisions Federal-Aid Construction Contract (Form FHWA PR 1273)* provided by the Department, without subsequent modification, in all lower tier covered transactions.
5. The prequalified bidder may rely upon a certification of a participant in a lower tier covered transaction that he is not debarred, suspended, ineligible, or voluntarily excluded from the covered transaction, unless he knows that the certification is erroneous. The bidder may decide the method and frequency by which he will determine the eligibility of his subcontractors.
6. Nothing contained in the foregoing shall be construed to require establishment of a system of records in order to render in good faith the certification required by this provision. The knowledge and information of a participant is not required to exceed that which is normally possessed by a prudent person in the ordinary course of business dealings.
7. Except as authorized in paragraph 6 herein, the Department may terminate any contract if the bidder knowingly enters into a lower tier covered transaction with a person who is suspended, debarred, ineligible, or voluntarily excluded from participation in this transaction, in addition to other remedies available by the Federal Government.

DEBARMENT CERTIFICATION

The prequalified bidder certifies to the best of his knowledge and belief, that he and his principals:

- a. Are not presently debarred, suspended, proposed for debarment, declared ineligible, or voluntarily excluded from covered transactions by any Federal department or agency;
- b. Have not within a three-year period preceding this proposal been convicted of or had a civil judgment rendered against them for commission of fraud or a criminal offense in connection with obtaining, attempting to obtain, or performing a public (Federal, State or local) transaction or contract under a public transaction; violation of Federal or State antitrust statutes or commission of embezzlement, theft, forgery, bribery, falsification or destruction of records; making false statements; or receiving stolen property;
- c. Are not presently indicted for or otherwise criminally or civilly charged by a governmental entity (Federal, State or local) with commission of any of the offenses enumerated in paragraph b. of this certification; and
- d. Have not within a three-year period preceding this proposal had one or more public transactions (Federal, State or local) terminated for cause or default.
- e. Will submit a revised Debarment Certification immediately if his status changes and will show in his bid proposal an explanation for the change in status.

If the prequalified bidder cannot certify that he is not debarred, he shall provide an explanation with this submittal. An explanation will not necessarily result in denial of participation in a contract.

Failure to submit a non-collusion and debarment certification will result in the prequalified bidder's bid being considered non-responsive.

Check here if an explanation is attached to this certification.

Contract No. **C204131**

County (ies): **Wayne**

ACCEPTED BY THE
DEPARTMENT OF TRANSPORTATION

DocuSigned by:

Ronald E. Davenport, Jr.

F81B6038A47A442...

Contract Officer

4/13/2020

Date

Execution of Contract and Bonds
Approved as to Form:

DocuSigned by:

Elizabeth C Stone

E7F92784822C49C...

Attorney General

4/13/2020

Date

Signature Sheet (Bid - Acceptance by Department)

Bond No. 056042Q

Contract No. C204131
County Wayne

Rev 5-17-11

CONTRACT PAYMENT BOND

Date of Payment Bond Execution March 19, 2020

Name of Principal Contractor BridgePoint Civil, LLC

Name of Surety: Westfield Insurance Company

Name of Contracting Body: North Carolina Department of Transportation
Raleigh, North Carolina

Amount of Bond: Fifteen Million Three Hundred Forty Six Thousand Seven
Hundred Four Dollars and 64/100 \$15,346,704.64

Contract ID No.: C204131

County Name: Wayne

KNOW ALL MEN BY THESE PRESENTS, That we, the **PRINCIPAL CONTRACTOR** (hereafter, **PRINCIPAL**) and **SURETY** above named, are held and firmly bound unto the above named Contracting Body, hereinafter called the Contracting Body, in the penal sum of the amount stated above for the payment of which sum well and truly to be made, we bind ourselves, our heirs, executors, administrators, and successors, jointly and severally, firmly by these presents.

THE CONDITION OF THIS OBLIGATION IS SUCH, that whereas the principal entered into a certain contract with the Contracting Body, numbered as shown above and hereto attached:

NOW THEREFORE, if the principal shall promptly make payment to all persons supplying labor and material in the prosecution of the work provided for in said contract, and any and all duly authorized modifications of said contract that may hereafter be made, notice of which modifications to the surety being hereby waived, then this obligation to be void; otherwise to remain in full force and virtue.

IN WITNESS WHEREOF, the above-bound parties have executed this instrument under their several seals on the date indicated above, the name and corporate seal of each corporate party being hereto affixed and these presents duly signed by its undersigned representative, pursuant to authority of its governing body.

Contract No. C204131
County Wayne

Rev 5-17-11

CONTRACT PAYMENT BOND

Affix Seal of Surety Company

Westfield Insurance Company
Print or type Surety Company Name

By Michelle A. Adams
Print, stamp or type name of Attorney-in-Fact

By: 
Signature of Attorney-in-Fact



Signature of Witness

Rhonda Smith
Print or type Signer's name

8540 Colonnade Center Drive, Suite 111, Raleigh, NC 27615
Address of Attorney-in-Fact

Contract No. C204131
County Wayne

Rev 5-17-11

**CONTRACT PERFORMANCE BOND
LIMITED LIABILITY COMPANY
SIGNATURE OF CONTRACTOR (Principal)**

Name of Contractor BridgePoint Civil, LLC
Full name of Firm

P.O. Box 729, Pikeville, NC 27863
Address as prequalified

By: 
Signature of Member, Manager, Authorized Agent
Select appropriate title

Jeremy Smith CEO / President
Print or type Signer's name



Bond No. 056042Q

Rev 5-17-11

Contract No. C204131
County Wayne

CONTRACT PERFORMANCE BOND

Date of Performance Bond Execution: March 19, 2020
Name of Principal Contractor: BridgePoint Civil, LLC
Name of Surety: Westfield Insurance Company
Name of Contracting Body: North Carolina Department of Transportation
Raleigh, North Carolina
Amount of Bond: Fifteen Million Three Hundred Forty Six Thousand Seven Hundred Four Dollars and 64/100 \$15,346,704.64
Contract ID No.: C204131
County Name: Wayne

KNOW ALL MEN BY THESE PRESENTS, That we, the **PRINCIPAL CONTRACTOR** (hereafter, **PRINCIPAL**) and **SURETY** above named, are held and firmly bound unto the above named Contracting Body, hereinafter called the Contracting Body, in the penal sum of the amount stated above for the payment of which sum well and truly to be made, we bind ourselves, our heirs, executors, administrators, and successors, jointly and severally, firmly by these presents.

THE CONDITION OF THIS OBLIGATION IS SUCH, that whereas the principal entered into a certain contract with the Contracting Body, numbered as shown above and hereto attached:

NOW THEREFORE, if the principal shall well and truly perform and fulfill all the undertakings, covenants, terms, conditions, and agreements of said contract during the original term of said contract and any extensions thereof that may be granted by the Contracting Body, with or without notice to the Surety, and during the life of any guaranty required under the contract, and shall also well and truly perform and fulfill all the undertakings, covenants, terms, conditions, and agreements of any and all duly authorized modifications of said contract that may hereafter be made, notice of which modifications to the surety being hereby waived, then this obligation to be void; otherwise to remain in full force and virtue.

IN WITNESS WHEREOF, the above-bound parties have executed this instrument under their several seals on the date indicated above, the name and corporate seal of each corporate party being hereto affixed and these presents duly signed by its undersigned representative, pursuant to authority of its governing body.

Contract No. C204131
County Wayne

Rev 5-17-11

CONTRACT PERFORMANCE BOND

Affix Seal of Surety Company

Westfield Insurance Company
Print or type Surety Company Name

By Michelle A. Adams
Print, stamp or type name of Attorney-in-Fact

By:

Signature of Attorney-in-Fact



Signature of Witness

Rhonda Smith
Print or type Signer's name

8540 Colonnade Center Drive, Suite 111, Raleigh, NC 27615
Address of Attorney-in-Fact

Contract No. C204131
County Wayne

Rev 5-17-11

**CONTRACT PERFORMANCE BOND
LIMITED LIABILITY COMPANY**

SIGNATURE OF CONTRACTOR (Principal)

Name of Contractor BridgePoint Civil, LLC
Full name of Firm

P.O. Box 729, Pikeville, NC 27863
Address as prequalified

By: 
Signature of Member, Manager, Authorized Agent
Select appropriate title



Jeremy Smith CEO / President
Print or type Signer's name

General
Power
of Attorney

**Westfield Insurance Co.
Westfield National Insurance Co.
Ohio Farmers Insurance Co.**
Westfield Center, Ohio

CERTIFIED COPY

Know All Men by These Presents, That WESTFIELD INSURANCE COMPANY, WESTFIELD NATIONAL INSURANCE COMPANY and OHIO FARMERS INSURANCE COMPANY, corporations, hereinafter referred to individually as a "Company" and collectively as "Companies," duly organized and existing under the laws of the State of Ohio, and having its principal office in Westfield Center, Medina County, Ohio, do by these presents make, constitute and appoint **Michelle A. Adams**, SEVERALLY

of Raleigh and State of NC its true and lawful Attorney-in-Fact, with full power and authority hereby conferred in its name, place and stead, to execute, acknowledge and deliver any and all bonds, recognizances, undertakings, or other instruments or contracts of suretyship-

Surety Bond No.: 056042Q
Principal: BridgePoint Civil, LLC
Obligee: North Carolina Department of Transportation

LIMITATION: THIS POWER OF ATTORNEY CANNOT BE USED TO EXECUTE NOTE GUARANTEE, MORTGAGE DEFICIENCY, MORTGAGE GUARANTEE, OR BANK DEPOSITORY BONDS.

and to bind any of the Companies thereby as fully and to the same extent as if such bonds were signed by the President, sealed with the corporate seal of the applicable Company and duly attested by its Secretary, hereby ratifying and confirming all that the said Attorney(s)-in-Fact may do in the premises. Said appointment is made under and by authority of the following resolution adopted by the Board of Directors of each of the WESTFIELD INSURANCE COMPANY, WESTFIELD NATIONAL INSURANCE COMPANY and OHIO FARMERS INSURANCE COMPANY:

"Be It Resolved, that the President, any Senior Executive, any Secretary or any Fidelity & Surety Operations Executive or other Executive shall be and is hereby vested with full power and authority to appoint any one or more suitable persons as Attorney(s)-in-Fact to represent and act for and on behalf of the Company subject to the following provisions:

The Attorney-in-Fact may be given full power and authority for and in the name of and on behalf of the Company, to execute, acknowledge and deliver, any and all bonds, recognizances, contracts, agreements of indemnity and other conditional or obligatory undertakings and any and all notices and documents canceling or terminating the Company's liability thereunder, and any such instruments so executed by any such Attorney-in-Fact shall be as binding upon the Company as if signed by the President and sealed and attested by the Corporate Secretary."

"Be It Further Resolved, that the signature of any such designated person and the seal of the Company heretofore or hereafter affixed to any power of attorney or any certificate relating thereto by facsimile, and any power of attorney or certificate bearing facsimile signatures or facsimile seal shall be valid and binding upon the Company with respect to any bond or undertaking to which it is attached." (Each adopted at a meeting held on February 8, 2000).

In Witness Whereof, WESTFIELD INSURANCE COMPANY, WESTFIELD NATIONAL INSURANCE COMPANY and OHIO FARMERS INSURANCE COMPANY have caused these presents to be signed by their National Surety Leader and Senior Executive and their corporate seals to be hereto affixed this 17th day of DECEMBER A.D., 2019.

Corporate
Seals
Affixed



WESTFIELD INSURANCE COMPANY
WESTFIELD NATIONAL INSURANCE COMPANY
OHIO FARMERS INSURANCE COMPANY

By: 
Gary W. Stumper, National Surety Leader and Senior Executive

State of Ohio
County of Medina ss.:

On this 17th day of DECEMBER A.D., 2019, before me personally came **Gary W. Stumper** to me known, who, being by me duly sworn, did depose and say, that he resides in **Hartford, CT**; that he is **National Surety Leader and Senior Executive** of WESTFIELD INSURANCE COMPANY, WESTFIELD NATIONAL INSURANCE COMPANY and OHIO FARMERS INSURANCE COMPANY, the companies described in and which executed the above instrument; that he knows the seals of said Companies; that the seals affixed to said instrument are such corporate seals; that they were so affixed by order of the Boards of Directors of said Companies; and that he signed his name thereto by like order.

Notarial
Seal
Affixed



David A. Kotnik, Attorney at Law, Notary Public
My Commission Does Not Expire (Sec. 147.03 Ohio Revised Code)

State of Ohio
County of Medina ss.:

I, **Frank A. Carrino**, Secretary of WESTFIELD INSURANCE COMPANY, WESTFIELD NATIONAL INSURANCE COMPANY and OHIO FARMERS INSURANCE COMPANY, do hereby certify that the above and foregoing is a true and correct copy of a Power of Attorney, executed by said Companies, which is still in full force and effect; and furthermore, the resolutions of the Boards of Directors, set out in the Power of Attorney are in full force and effect.

In Witness Whereof, I have hereunto set my hand and affixed the seals of said Companies at Westfield Center, Ohio, this 19th day of March A.D., 2020.



Frank A. Carrino, Secretary